



RESTAURANT
HOTEL

We strongly believe in the uniqueness of the single individual. We do not want a homogeneous world, where everyone thinks alike.
All we do is offer our customers the opportunity to stand out by becoming unique

We do all this starting from a family production tradition of over 70 years, made of craftsmanship of the highest quality and experience, combined with the most advanced technological solutions.

We produce unique and bespoke professional tools to suit your culinary art.

Since 1947

Crediamo fermamente nell'unicità del singolo individuo. Non vogliamo un mondo omogeneo, dove tutti pensano allo stesso modo.
Tutto quello che facciamo è offrire ai nostri clienti la possibilità di distinguersi, diventando unici.

Facciamo tutto questo partendo da una tradizione familiare produttiva di oltre 70 anni, fatta di artigianato ad altissima qualità ed esperienza, unito alle più avanzate soluzioni tecnologiche.

Produciamo articoli professionali unici e su misura, per soddisfare la vostra arte culinaria.

Mepra and
Pininfarina have
created STILE, a
refined collection
for the lovers of
Italian beauty.
We created a
s e p a r a t e d
catalog, only for
this collection.

STILE

by pininfarina

Dalla collabora-
zione di Mepra e
Pininfarina, nasce
STILE, una
c o l l e z i o n e
raffinata e
innovativa per gli
amanti della
bellezza italiana.
A b b i a m o
realizzato un
catalogo a parte,
solo per questa
collezione.

Icon of timeless beauty



Cisitalia, 1947: una scultura in movimento esposta permanentemente al MoMA di New York.

Cisitalia, 1947: a sculpture in movement Exposed at MoMA in New York.

The finishings
and the colors in
the following
pages, are
available for all
the flatware
models and for
the serveware.

Mepra Atelier

Le finiture ed i
colori presenti
nelle pagine
seguenti, sono
disponibili per
tutti i modelli di
posate e per tutto
il vasellame.





Mirror



O

Oro
Lucido



ON

Oro Nero
Lucido



B

Bronzo
Lucido



C

Champagne
Lucido



A

Arcobaleno
Lucido



AR

Argentato
Lucido



Ice



OI

ION

IB

IC

IA

ARI

Oro
Ice

Oro Nero
Ice

Bronzo
Ice

Champagne
Ice

Arcobaleno
Ice

Argentato
Ice



Peltro



PO

Oro
Peltro

PON

Oro Nero
Peltro

PB

Bronzo
Peltro

PC

Champagne
Peltro

PA

Arcobaleno
Peltro

PAR

Argentato
Peltro

MEPRA
S. p. A.
H & R D I V I S I O N

Posate



FLATWARE COUVERTS BESTECKE CUBIERTOS

- Gamma completa per ogni modello
 - Spessore elevato
 - Rebbi delle forchette lavorati internamente
 - Seghettatura lame passante per un taglio perfetto
- Each collection consists of an extensive range of pieces.
- Thick stainless steel.
 - Fork tines are polished on all sides for a lifetime of performance.
 - Knife blades have a micro-serration for an effortless cut.
- Chaque modèle est complet de toute le pièces nécessaire
- Épaisseur massifs
 - Fourchons des fourchettes intérieurement travaillés
 - Les couteaux possèdent la dentelure fin ouvragée pour une coupe facile
- Jedes Modell verfügt über eine komplette Bandbreite an Zusatzteilen
- Hohe Materialstärke
 - Exakte, maschinell gefertigte Gabelzinken
 - Genauste Ausbildung der Messerschneiden für einen perfekteren Schnitt
- Cada modelo esta completo de todo lo necesario
- Espesor macizo
 - Tenedores con púas pulidas internamente.
 - Cuchillos con hoja sierra; corte perfecto

MEPRA
S.p.A.





Mirror



Code	mm.	inch.
01	199	7 7/8
02	199	7 7/8
03	228	9
04	176	6 7/8
05	176	6 7/8
06	203	8
07	135	5 1/8
08	108	4 1/4
09	330	13
10	235	9 1/4
11	235	9 1/4
12	228	9
13	203	8
15	150	5 7/8
16	251	9 7/8
20	195	7 7/8
21	195	7 7/8
22	235	9 1/4
23	235	9 1/4
25	185	7 1/4
35	175	6 7/8
36	228	9
37	170	6 3/4
39	175	6 7/8
40	185	7 1/4
45	183	7 1/5

Coltelli disponibili anche con manico vuoto
 Hollow handle knives available
 Couteaux disponibles aussi avec un manche creux
 Messer in Hohlheft-Ausführung erhältlich
 Cuchillo disponible también en mango hueco



Code	mm.	inch.
01	201	7 7/8
02	201	7 7/8
03	230	9
04	180	7
05	177	7
06	202	8
07	139	5 1/2
08	110	4 1/3
09	304	12
10	243	9 5/8
11	243	9 5/8
15	145	5 3/4
16	243	9 5/8
20	210	8 1/4
21	192	7 1/2
22	243	9 1/2
23	243	9 1/2
25	201	8
35	180	7
36	227	9
37	164	6 1/2
39	180	7
40	175	6 7/8
45	203	8

Tutti i pezzi di questo modello sono realizzati in forgia
 All pieces in this range are forged
 Toutes les pièces de ce modèle sont forgées
 Alle Teile dieses Modells sind geschmiedet.
 Todas las piezas de este modelo son hechas en forgia

mm 9,0
ARIA



Code	mm.	inch.
01 	208	8 1/5
02 	208	8 1/5
03 	235	9 1/4
04 	185	7 1/4
05 	185	7 1/4
06 	205	8
07 	140	5 1/2
08 	120	4 3/4
09 	275	10 3/5
10 	250	9 1/5
11 	250	9 1/5
15 	155	6 1/5
16 	260	10 1/4
20 	210	8 1/4
21 	185	7 1/4
22 	250	9 1/5
23 	250	9 1/5
25 	201	7 1/5
26 	156	6 1/7
35 	185	7 1/4
36 	235	9 1/4
37 	183	7 1/5
39 	185	7 1/4
40 	180	7
45 	183	7 1/4

I coltelli appoggiano sulla lama
 Knives may be set blade-down
 Les couteaux peuvent être posés debout sur leurs lames
 Durch das aussergewöhnliche Design, ist es möglich, die
 jeweiligen Messer auch hochkant, also "auf der Klinge
 stehend", abzustellen.
 Los cuchillos pueden apoyarse sobre la hoja.

Tutti i pezzi di questo modello sono realizzati in forgia
 All pieces in this range are forged
 Toutes les pièces de ce modèle sont forgées
 Alle Teile dieses Modells sind geschmiedet
 Todas las piezas de este modelo son hechas en forja



Code	mm.	inch.
01	210	8 1/4
02	210	8 1/4
03	235	9 1/4
04	190	7 1/2
05	190	7 1/2
06	212	8 1/3
07	138	5 1/5
08	109	4 1/3
09	290	11 1/5
10	240	9 1/2
11	238	9 1/8
15	158	6 1/4
16	259	10 1/5
20	223	8 1/4
21	208	8 1/5
22	240	9 1/2
23	240	9 1/2
25	208	8 1/5
36	234	9 1/5
37	178	7
39	192	7 1/2
40	175	6 1/8

mm 4,0

ATENA



Code	mm.	inch.
01	200	7 7/8
02	202	8
03	221	8 3/4
04	180	7
05	180	7
06	198	7 3/4
07	135	5 1/3
08	114	4 1/2
09	312	12 1/8
10	235	9 1/4
11	240	9 1/2
15	150	5 7/8
16	255	10
20	210	8 1/4
21	202	8
22	235	9 1/4
23	235	9 1/4
25	185	7 1/4
31	114	4 1/2
35	180	7
36	221	8 3/4
37	162	6 1/5
39	180	7
40	185	7 1/4





Code		mm.	inch.
01		204	8
02		204	8
03		246	9 2/3
04		175	6 7/8
05		175	6 7/8
06		220	8 2/3
07		135	5 1/3
08		111	4 1/8
09		313	12 1/3
10		253	10
11		253	10
12		245	9 2/3
13		220	8 2/3
15		154	6
16		241	9 1/2
20		207	8 1/7
21		207	8 1/7
22		253	10
23		253	10
26		164	6 1/2
35		175	6 7/8
36		245	9 2/3
37		169	6 2/3
39		175	6 7/8
40		187	7 1/8
45		192	7 1/2

Coltelli disponibili anche con manico vuoto
 Hollow handle knives available
 Couteaux disponibles aussi avec un manche creux
 Messer in Hohlheft-Ausführung erhältlich
 Cuchillo disponible también en mango hueco

mm 4,0
BAVARIA



Code	mm.	inch.
01	207	8 1/7
02	207	8 1/7
03	235	9 1/4
04	180	7
05	180	7
06	204	8
07	135	5 1/3
08	114	4 1/2
09	315	12 1/2
10	250	9 1/8
11	250	9 1/8
12	235	9 1/4
13	204	8
15	155	6
16	244	9 1/8
20	180	7
21	179	7
22	250	9 1/8
23	250	9 1/8
24	140	5 1/2
25	195	7 1/3
26	155	6 1/3
35	180	7
36	224	8 1/5
37	170	6 1/2
39	180	7
40	184	7 1/4
44	165	6 1/2
45	205	8

Coltelli disponibili anche con manico vuoto
 Hollow handle knives available
 Couteaux disponibles aussi avec un manche creux
 Messer in Hohlheft-Ausführung erhältlich
 Cuchillo disponible también en mango hueco

BOHEME mm 3,0



Code		mm.	inch.
01		204	8
02		203	8
03		232	9 1/8
04		185	7 1/4
05		184	7 1/4
06		210	8 1/4
07		134	5 1/4
08		110	4 1/3
09		288	11 1/3
10		240	9 2/3
11		241	9 1/2
15		158	6 1/5
16		258	10
20		198	7 1/2
21		184	7 1/4
25		185	7 1/4
35		182	7 1/5
36		234	9 1/5
37		172	6 3/4

mm 3,0
CARINZIA



Code		mm.	inch.
01		201	7 7/8
02		201	7 7/8
03		232	9 1/8
04		170	6 2/3
05		175	6 7/8
06		199	7 7/8
07		133	5 1/4
08		110	4 1/3
10		250	9 5/8
11		255	10
15		152	6
20		210	8 1/4
21		201	7 7/8
22		250	9 5/8
23		250	9 5/8
25		195	7 2/3
26		155	6 1/8
36		224	8 2/3
37		171	6 3/4
39		170	6 2/3
45		182	7 1/8

09

DIAMANTE mm 4,0



Code	mm.	inch.
01	206	8 1/5
02	206	8 1/5
03	240	9 4/5
04	178	7
05	178	7
06	214	8 4/5
07	133	5 1/4
08	113	4 4/5
09	315	12 3/5
10	245	9 2/3
11	245	9 2/3
12	240	9 4/5
13	214	8 4/5
15	155	6
16	241	9 1/2
20	210	8 3/4
21	206	8 1/5
22	240	9 4/5
23	244	9 2/5
25	208	8 1/6
26	156	6 1/7
35	178	7
36	240	8 4/5
37	169	6 2/3
39	178	7
40	183	7 1/5
45	177	7



PELTRO

Coltelli disponibili anche con manico vuoto
 Hollow handle knives available
 Couteaux disponibles aussi avec un manche creux
 Messer in Hohlheft-Ausführung erhältlich
 Cuchillo disponible también en mango hueco

mm 4,0
DOLCE VITA

Code	mm.	inch.
01	200	7 7/8
02	200	7 7/8
03	225	8 7/8
04	175	6 7/8
05	180	7
06	200	7 7/8
07	135	5 1/3
08	110	4 1/3
09	298	11 1/4
10	235	9 1/4
11	245	9 5/8
15	150	6
16	252	10
20	185	7 1/4
21	185	7 1/4
22	235	9 1/4
23	235	9 1/4
25	185	7 1/4
35	180	7
36	225	8 7/8
37	193	7 1/2
39	178	7
40	180	7
45	189	7 1/2



-  ICE
-  ORO
ICE
-  ORO
NERO
-  BRONZO
-  CHAMPAGNE
-  ARCOBALENO



Code		mm.	inch.
01		205	8
02		206	8 1/8
03		235	9 1/4
04		175	6 7/8
05		175	6 7/8
06		202	8
07		134	5 1/4
08		111	4 1/3
09		302	11 7/8
10		231	9
11		233	9 1/6
15		157	6 1/6
16		241	9 1/2
20		184	7 1/4
21		175	6 7/8
22		231	9
23		231	9
25		195	7 1/3
36		235	9 1/4
37		175	6 7/8
39		175	6 7/8
40		173	6 1/3

mm 4,0

ELICA



Code	mm.	inch.
01	203	8
02	200	7 7/8
03	220	8 2/3
04	178	7
05	185	7 1/4
06	195	7 1/2
07	135	5 1/3
08	113	4 1/2
09	310	12 1/5
10	245	9 1/2
11	241	9 1/2
15	150	5 7/8
16	255	10
20	197	7 3/4
21	185	7 1/2
22	245	9 1/2
23	245	9 1/2
25	201	8
35	178	7
36	220	8 1/3
37	195	7 1/2
39	178	7
40	180	7



Code	mm.	inch.
01	209	8 1/5
02	209	8 1/5
03	240	9 1/2
04	180	7
05	180	7
06	214	8 3/5
07	136	5 1/3
08	114	4 1/2
09	315	12 3/5
10	250	9 7/8
11	250	9 7/8
12	240	9 1/2
13	214	8 3/5
15	155	6
16	243	9 1/2
20	210	8 1/4
21	207	8 1/7
22	250	9 7/8
23	250	9 7/8
25	194	7 3/5
26	155	6 1/5
35	190	7 1/2
36	227	9
37	172	6 3/4
39	180	7
40	184	7 1/4
44	165	6 1/2
45	208	8 1/6



Coltelli disponibili anche con manico vuoto
 Hollow handle knives available
 Couteaux disponibles aussi avec un manche creux
 Messer in Hohlheft-Ausführung erhältlich
 Cuchillo disponible también en mango hueco

mm 4,0
EPOQUE



Code		mm.	inch.
01		205	8
02		200	7 1/8
12		215	8 1/2
04		193	7 1/2
05		178	7
13		192	7 1/2
07		138	5 1/2
09		293	11 1/2
10		249	9 1/2
11		249	9 1/2
15		172	6 1/4
16		252	10
20		211	8 1/3
21		204	8
40		201	7 1/2



Angelo Mangiarotti

Posata realizzata a manico vuoto.
 Hollow handle manufactured cutlery.
 Couvert réalisée avec les manches
 vides.
 Bestecke in Hohlheft-Ausführung
 verarbeitet.
 Cubierto hecha en mango hueco.

1322

ERGONOMICA



Code	mm.	inch.
01	210	8 1/4
02	210	8 1/4
03	234	9 1/5
04	190	7 1/2
05	187	7 1/3
06	208	8 1/5
07	142	5 1/5
08	120	4 1/4
09	300	11 1/5
10	255	10
11	250	9 1/6
15	160	6 1/3
16	280	11
20	212	8 1/3
21	186	7 1/3
22	255	10
23	255	10
25	195	7 1/3
35	188	7 1/5
36	234	9 1/5
37	198	7 1/5
39	190	7 1/2
40	191	7 1/2
45	193	7 1/5

I coltelli appoggiano sulla lama
 Knives may be set blade-down
 Les couteaux peuvent être posés debout sur leurs lames
 Durch das aussergewöhnliche Design, ist es möglich, die
 jeweiligen Messer auch hochkant, also "auf der Klinge
 stehend", abzustellen.
 Los cuchillos pueden apoyar sobre la hoja.

Tutti i pezzi di questo modello sono realizzati in forgia
 All pieces in this range are forged
 Toutes les pièces de ce modèle sont forgées
 Alle Teile dieses Modells sind geschmiedet
 Todas las piezas de este modelo son hechas en forgia

mm 5,0
FORMA

Code	mm.	inch.
01	214	8 1/5
02	214	8 1/5
03	247	9 1/4
04	189	7 1/5
05	189	7 1/5
06	218	8 1/5
07	144	5 1/3
08	116	4 1/2
09	300	11 1/5
10	256	10
11	256	10
15	156	6 1/7
16	274	10 1/4
20	212	8 1/5
21	189	7 1/5
22	256	10
23	256	10
36	247	9 1/4
37	218	8 1/5
44	165	6 1/2

























ADV
Astier de Villatte

12

GINEVRA mm 3,0



























Code		mm.	inch.
01		195	7 7/8
02		195	7 7/8
03		218	8 5/8
04		173	6 7/8
05		173	6 7/8
06		195	7 7/8
07		130	5 1/8
08		112	4 3/8
09		299	11 3/4
10		234	9 1/5
11		234	9 1/5
15		154	6
16		251	9 7/8
20		197	7 3/4
21		195	7 7/8
22		234	9 1/5
23		234	9 1/5
25		185	7 1/3
35		175	6 7/8
36		218	8 5/8
37		153	6
39		173	6 7/8
40		184	7 1/4

mm 3,0
GOCCIA











Code	mm.	inch.
01	202	8
02	202	8
03	231	9
04	176	6 7/8
05	176	6 7/8
06	204	8
07	138	5 1/2
08	106	4 1/6
09	330	13
10	235	9 1/4
11	235	9 1/4
15	150	5 7/8
16	251	9 7/8
20	202	8
21	202	8
22	235	9 1/4
23	235	9 1/4
25	185	7 1/4
36	210	8 1/4
37	185	7 1/4
39	182	7 1/6
40	185	7 1/4



Code	mm.	inch.
01 	203	8
02 	203	8
03 	210	8 1/4
04 	177	7
05 	177	7
06 	190	7 1/2
07 	133	5 1/4
08 	113	4 1/2
09 	308	12 1/8
10 	237	9 1/2
11 	237	9 1/2
15 	157	6 1/8
16 	248	9 3/4
18 	241	9 1/2
20 	203	8
21 	203	8
22 	237	9 1/2
23 	237	9 1/2
24 	134	5 1/4
25 	185	7 1/4
35 	177	7
37 	177	7
39 	177	7
40 	187	7 1/2
45 	177	7



mm 3,0
ITALIA

Code		mm.	inch.
01		207	8 1/2
02		201	7 7/8
03		219	8 2/5
04		178	7
07		134	5 1/4
08		120	4 3/4
15		135	5 1/3
21		210	8 1/4

Arch. Katja Bremkamp

The asymmetrical and rather unfamiliar shape of this cutlery range was influenced by the way we handle certain situations relating to the table routine. I was looking at the movements of the hands when dishing food out of bowls, when serving onto a plate and how this movement alters when food is conveyed into the mouth. Each piece reflects these movements individually, referring to their purposes and their "actions", as some pieces are more asymmetrical than others. The overall asymmetrical shape of this range therefore supports the comfortable handling of cutlery and also acts as guide to the person who is using it.

La forma asimmetrica e non convenzionale di questo modello è stata influenzata dall'osservazione dei comportamenti e delle routine legate al consumo del cibo a tavola. Ho guardato i movimenti delle mani durante la disposizione del cibo sul piatto, la raccolta del boccone e l'accompagnamento alla bocca. Ogni pezzo riflette individualmente questi movimenti, riferendosi al loro scopo e alle loro azioni; questo spiega il motivo per cui alcuni pezzi sono più asimmetrici di altri. Oltretutto, l'asimmetria di questa linea avvantaggia la maneggevolezza della posata in modo da guidare la persona che la usa.



ICE



Code		mm.	inch.
01		208	8 1/5
02		208	8 1/5
03		235	9 1/4
04		180	7
05		180	7
06		210	8 1/4
07		133	5 1/4
08		115	4 1/2
09		315	12 1/5
10		248	9 3/4
11		245	9 3/5
12		235	9 1/4
13		210	8 1/4
15		156	6 1/2
16		242	9 1/2
20		210	8 1/4
21		210	8 1/4
22		248	9 3/4
23		248	9 3/4
24		134	5 1/4
25		205	8
26		156	6 1/2
35		180	7
36		235	9 1/4
37		170	6 2/3
39		180	7
40		185	7 1/4
44		175	6 2/3
45		180	7

Coltelli disponibili anche con manico vuoto
 Hollow handle knives available
 Couteaux disponibles aussi avec un manche creux
 Messer in Hohlheft-Ausführung erhältlich
 Cuchillo disponible también en mango hueco

mm 4,0
LEONARDO



Code		mm.	inch.
01		205	8
02		205	8
03		233	9 1/6
04		179	7
05		179	7
06		200	7 7/8
07		135	5 1/3
08		113	4 2/5
09		316	12 2/5
10		239	9 2/5
11		245	9 2/3
15		160	6 1/3
16		244	9 2/5
20		205	8
21		208	8 1/3
22		239	9 2/5
23		239	9 2/5
25		201	8
26		158	6 1/5
35		155	6 1/3
36		233	9 1/6
37		163	6 2/5
39		179	7
40		182	7 1/6
45		179	7



Maurizio Duranti

30

LEVANTINA mm 3,5



Code	mm.	inch.
01 	200	7 7/8
02 	203	8
03 	235	9 1/4
04 	178	7
05 	180	7
06 	205	8
07 	135	5 1/3
08 	115	4 1/2
09 	305	12
10 	245	9 2/3
11 	245	9 2/3
15 	150	6
16 	246	9 2/3
20 	200	7 7/8
21 	187	7 1/3
22 	245	9 2/3
23 	245	9 2/3
25 	185	7 1/3
35 	178	7
36 	235	9 1/4
37 	178	7
39 	178	7
40 	190	7 1/2

-  ICE
-  ORO
ICE
-  ORO
NERO
-  BRONZO
-  CHAMPAGNE
-  ARCOBALENO

mm 4,0
LINEA

Coltelli disponibili anche con manico vuoto
 Hollow handle knives available
 Couteaux disponibles aussi avec un manche creux
 Messer in Hohlheft-Ausführung erhältlich
 Cuchillo disponible también en mango hueco

Code	mm.	inch.
01	208	8 1/5
02	208	8 1/5
03	224	8 7/5
04	183	7 1/5
05	183	7 1/5
06	195	7 2/3
07	135	5 1/3
08	115	4 1/2
09	293	11 1/2
10	265	10 2/5
11	265	10 2/5
12	224	8 7/5
13	195	7 2/3
15	152	6
16	257	10 1/3
20	223	8 3/4
21	209	8 1/5
22	265	10 2/5
23	265	10 2/5
25	201	8
26	152	6
35	183	7 1/5
36	224	8 7/5
37	171	6 3/4
39	183	7 1/5
40	180	7



ICE



**Diciottesimo
 Premio Compasso d'Oro
 ADI**

Mediterranea
 Pisate
Maurizio Duranti
 Designer
Mepra spa
 Produttore

Selezione d'onore
 Compasso d'Oro
 ADI 1998

MEDITERRANEA mm 3,5



Code	mm.	inch.
01	209	8 1/5
02	209	8 1/5
03	235	9 1/4
04	180	7
05	180	7
06	215	8 1/5
07	136	5 1/3
08	114	4 1/2
09	315	12 1/5
10	250	9 1/6
11	250	9 1/6
12	235	9 1/4
13	204	8
15	155	6 1/5
16	243	9 1/2
18	253	10
19	251	9 1/5
20	210	8 1/4
21	207	8 1/7
22	250	9 1/6
23	250	9 1/6
24	140	5 1/2
25	195	7 1/3
26	155	6 1/5
35	190	7 1/2
36	224	8 1/5
37	170	6 2/3
39	180	7
40	184	7 1/4
44	165	6 1/2
45	208	8 1/6

Coltelli disponibili anche con manico vuoto
 Hollow handle knives available
 Couteaux disponibles aussi avec un manche creux
 Messer in Hohlheft-Ausführung erhältlich
 Cuchillo disponible también en mango hueco

mm 3,0
BRESCIA

20B



Code	mm.	inch.
01	211	8 1/5
02	211	8 1/5
03	239	9 1/5
04	181	7 1/6
05	181	7 1/6
06	215	8 1/5
07	135	5 1/3
08	114	4 1/2
09	314	12 1/3
10	250	9 1/6
11	250	9 1/6
15	158	6 1/5
16	241	9 1/2
20	213	8 1/5
21	211	8 1/5
22	250	9 1/6
23	250	9 1/6
25	201	8
26	159	6 1/4
35	189	7 1/5
36	235	9 1/4
37	174	6 1/6
39	189	7 1/5
40	190	7 1/2
45	189	7 1/5
49	149	5 1/6



Code		mm.	inch.
01		201	8
02		201	8
03		219	8 1/5
04		180	7
05		180	7
06		195	7 1/3
07		140	5 1/2
08		113	4 1/5
09		320	12 1/5
10		245	9 1/3
11		245	9 1/3
15		153	6
16		256	10
20		213	8 1/5
21		206	8 1/5
22		245	9 1/3
23		245	9 1/3
25		201	8
35		180	7
36		219	8 1/5
37		195	7 1/3
39		180	7
40		190	7 1/2

Giulio Iacchetti

mm 3,0
MORGANA



Code	mm.	inch.
01	200	7 7/8
02	204	8
03	230	9
04	180	7
05	180	7
06	204	8
07	135	5 1/3
08	113	4 2/5
09	310	12 1/5
10	240	9 1/2
11	245	9 2/3
15	150	5 7/8
16	252	10
20	222	8 3/4
21	203	8
22	240	9 1/2
23	240	9 1/2
25	201	8
35	180	7
36	230	9
37	204	8
39	180	7
40	180	7

I coltelli appoggiano sulla lama
 Knives may be set blade-down
 Les couteaux peuvent être posés debout sur
 leurs lames
 Durch das aussergewöhnliche Design, ist es
 möglich, die jeweiligen Messer auch hochkant,
 also "auf der Klinge stehend", abzustellen.
 Los cuchillos pueden apoyar sobre la hoja



Code	mm.	inch.
01	201	7 7/8
02	201	7 7/8
03	232	9 1/8
04	170	6 2/3
05	175	6 7/8
06	199	7 7/8
07	133	5 1/4
08	110	4 1/3
09	314	12 1/2
10	250	9 7/8
11	255	10
12	232	9 1/8
13	199	7 7/8
15	152	6
16	245	9 2/3
20	170	6 2/3
21	173	6 7/8
22	250	9 7/8
23	250	9 7/8
25	195	7 3/4
26	155	6 1/8
35	175	6 7/8
36	224	8 7/8
37	171	6 3/4
39	170	6 2/3
40	190	7 1/2
45	182	7 1/8

ICE

Coltelli disponibili anche con manico vuoto
 Hollow handle knives available
 Couteaux disponibles aussi avec un manche creux
 Messer in Hohlheft-Ausführung erhältlich
 Cuchillo disponible también en mango hueco

mm 4,0
NATURA



Coltelli disponibili anche con manico vuoto
 Hollow handle knives available
 Couteaux disponibles aussi avec un manche creux
 Messer in Hohlheft-Ausführung erhältlich
 Cuchillo disponible también en mango hueco

Code	mm.	inch.
01	205	8
02	205	8
03	230	9
04	175	6 ⁷ / ₈
05	175	6 ⁷ / ₈
06	203	8
07	133	5 ¹ / ₄
08	112	4 ¹ / ₅
09	310	12 ¹ / ₅
10	254	10
11	255	10
12	230	9
13	203	8
15	152	6
16	243	9 ⁵ / ₈
20	206	8 ¹ / ₈
21	206	8 ¹ / ₈
22	254	10
23	254	10
24	135	5 ¹ / ₈
25	195	7 ⁵ / ₈
26	160	6 ¹ / ₈
27	160	6 ¹ / ₈
28	180	7
35	175	6 ⁷ / ₈
36	233	9 ¹ / ₆
37	171	6 ³ / ₄
39	175	6 ⁷ / ₈
40	188	7 ³ / ₈
44	165	6 ¹ / ₂
45	175	6 ⁷ / ₈



Code		mm.	inch.
01		207	8 1/7
02		207	8 1/7
03		236	9 3/4
04		179	7
05		179	7
06		213	8 3/5
07		134	5 1/4
08		113	4 3/5
09		300	11 1/5
10		248	9 3/4
11		248	9 3/4
15		155	6 1/8
16		257	10 1/5
20		179	7
21		179	7
22		248	9 3/4
23		248	9 3/4
25		195	7 7/5
26		155	6
35		175	6 3/5
36		227	9
37		172	6 3/4
39		170	6 2/5
40		180	7
45		179	7

mm 4,0
PERLA



Code	mm.	inch.
01	209	8 1/5
02	209	8 1/5
03	235	9 1/4
04	180	7
05	180	7
06	204	8
07	136	5 1/3
08	114	4 1/2
09	315	12 2/5
10	250	9 7/8
11	250	9 7/8
12	235	9 1/4
13	204	8
15	155	6
16	243	9 1/2
20	210	8 1/4
21	207	8 1/7
22	250	9 7/8
23	250	9 7/8
25	195	7 2/3
26	155	6 1/3
35	190	7 1/2
36	235	9 1/4
37	170	6 2/3
39	180	7
40	184	7 1/4
44	165	6 1/2
45	180	7

Coltelli disponibili anche con manico vuoto
 Hollow handle knives available
 Couteaux disponibles aussi avec un manche creux
 Messer in Hohlheft-Ausführung erhältlich
 Cuchillo disponible también en mango hueco



Code		mm.	inch.
01		205	8
02		205	8
03		236	9 1/5
04		180	7
05		180	7
06		200	7 7/8
07		135	5 1/5
08		115	4 1/2
09		320	12 3/5
10		250	9 7/8
11		250	9 7/8
12		236	9 1/5
13		200	7 7/8
15		155	6 1/5
16		242	9 1/2
20		180	7
21		180	7
22		250	9 7/8
23		250	9 7/8
25		195	7 3/5
26		155	6 1/5
35		180	7
36		224	8 3/5
37		170	6 3/5
39		180	7
40		185	7 1/4
44		165	6 1/2
45		208	8 1/5

Coltelli disponibili anche con manico vuoto
 Hollow handle knives available
 Couteaux disponibles aussi avec un manche creux
 Messer in Hohlheft-Ausführung erhältlich
 Cuchillo disponible también en mango hueco

mm 4,0
ROMA



Code	mm.	inch.
01	204	8
02	204	8
03	239	9 2/5
04	175	6 7/8
05	175	6 7/8
06	203	8
07	133	5 1/4
08	109	4 1/3
09	313	12 1/3
10	232	9 1/8
11	232	9 1/8
12	239	9 2/5
13	203	8
15	156	6 1/7
16	244	9 5/8
18	242	9 1/2
19	240	9 2/5
20	206	8 1/8
21	203	8
22	232	9 1/8
23	232	9 1/8
24	134	5 1/4
25	207	8 1/7
26	159	6 1/4
35	190	7 1/2
36	239	9 2/5
37	180	7
39	175	6 7/8
40	188	7 2/5
45	208	8 1/5

Coltelli disponibili anche con manico vuoto
 Hollow handle knives available
 Couteaux disponibles aussi avec un manche creux
 Messer in Hohlheft-Ausführung erhältlich
 Cuchillo disponible también en mango hueco



Code		mm.	inch.
01		208	8 1/5
02		208	8 1/5
03		234	9 1/5
04		185	7 1/4
05		183	7 1/5
06		208	8 1/5
07		138	5 3/5
08		109	4 1/3
09		317	12 1/2
10		240	9 1/2
11		245	9 3/5
15		157	6 1/5
16		240	9 1/2
20		182	7 1/6
21		175	6 4/5
22		240	9 1/2
23		240	9 1/2
25		185	7 1/4
40		175	6 4/5

mm 4,0

SPARTA



Code	mm.	inch.
01	204	8
02	201	7 7/8
03	231	9
04	184	7 1/4
05	182	7 1/5
06	209	8 1/5
07	135	5 1/3
08	110	4 1/3
09	280	11
10	231	9
11	234	9 1/5
15	153	6
16	260	10 1/4
20	197	7 3/4
21	201	7 7/8
25	185	7 1/3
35	178	7
36	230	9
37	172	6 1/4

Giulio Iacchetti



Code		mm.	inch.
01		200	7 7/8
02		200	7 7/8
03		211	8 1/3
04		177	7
05		177	7
06		189	7 1/5
07		135	5 1/3
08		112	4 1/5
09		295	11 3/5
10		240	9 1/2
11		240	9 1/2
13		189	7 1/5
15		150	5 4/5
16		256	10
20		215	8 1/5
21		199	7 4/5
22		240	9 1/2
23		240	9 1/2
25		201	8
37		189	7 1/5
39		177	7
40		183	7 1/5

Coltelli disponibili anche con manico vuoto
Hollow handle knives available
Couteaux disponibles aussi avec un manche creux
Messer in Hohlheft-Ausführung erhältlich
Cuchillo disponible también en mango hueco

mm 3,0
SVEVA





I modelli delle due pagine seguenti, sono già disponibili in magazzino nella versione satinata, ICE. Tutti gli altri modelli possono essere forniti in versione ICE, a richiesta, senza quantità minima

The models on the two following pages are already available in stock in the satin ICE version. All the other models can be supplied on request in the ICE version, without minimum quantity.

Les modèles des deux pages suivantes sont déjà disponible en stock dans la version avec la surface de fin brossée, ICE. Tous les autres modèles peuvent être fournis en version ICE, sur demande, sans quantité minimum.

Die Modelle auf den folgenden zwei Seiten sind Ausführungen in der matte, gebürstete ICE Oberfläche auf Lager bereits. Alle anderen Modelle können auf Anfrage ohne Mindestmenge in der ICE-Version geliefert werden

Los modelos de las dos páginas siguientes sonya disponible en el almacén en la versión ICE, con la superficie satinada. Todos los otros modelos se pueden suministrar en la versión ICE, bajo pedido, sin cantidad mínima.

Ice



45 DUE ICE



41 ITALIA ICE



39 LEVANTINA ICE



47 LINEA ICE



57 GINEVRA ICE



42 NATURA ICE



40 MEDITERRANEA ICE



53 AVANGUARDIA ICE



Peltro





I modelli di queste pagine, sono già disponibili in magazzino nella versione antichizzata, PELTRO. Tutti gli altri modelli possono essere forniti in versione PELTRO, a richiesta, senza quantità minima

The models on this pages are already available in stock in the antiqued PELTRO version. All the other models can be supplied on request in the PELTRO version, without minimum quantity.







Oro



DESIGNPREIS
2009

NOMINEE

La speciale finitura non è ottenuta con metodi tradizionali come verniciatura o bagno galvanico, ma con un processo di impiantazione molecolare a base di titanio, frutto della ricerca aerospaziale.

Il prodotto è garantito per il lavaggio in lavastoviglie, non si macchia, non si ossida e resiste alla corrosione.

Unlike products that are coated or made with a galvanic process, our's is obtained using a titanium based molecular embedding process originally developed through aerospace research.

The product is dishwasher-safe, will not stain or oxidize and is highly resistant to corrosion.

Le produit n'est pas enduit ou fait avec un processus galvanique, Il est obtenu avec un processus à base de titane de d'implantation Moléculaire qui est le résultat de la recherche aérospatiale.

Le produit passe au lave-vaisselle, ne rouille pas ou ne s'oxyde pas et ne marque pas.

Die hier und vorher abgebildeten Bestecke, die mit einer Oberfläche aus Titan versehen sind, haben exakt die Farbe von Gold (ORO ICE), tiefem Schwarz (ORO NERO) und Bronze (BRONZO), was der Gestaltung von Tischen und Wohnräumen völlig neue Akzente verleiht. Das angewendete Veredelungsverfahren (P.V.D.) kommt aus der Raumfahrttechnik und war bisher bei der Gestaltung von Tabletop-Artikeln noch nie nicht angewendet worden bzw. völlig unbekannt.

Diese Produkte haben Dank des Titans eine 4 mal so harte Oberfläche wie Edelstahl, sehen nicht nur schön aus, sondern sind absolut robust und für den täglichen Gebrauch bestens geeignet.

Anfang des Jahres 2008 bekamen die Besteckmodell den begehrten Designpreis "Design Plus 2008" verliehen

El acabado especial no se obtiene de métodos tradicionales como barnizados o baño galvanico, se obtiene mediante un proceso de implantación molecular a base de titanio, fruto de la búsqueda aeroespacial.

El producto esta garantizado para el lavado en lava-vajillas, no se mancha, no se oxida y es resistente a la corrosión.



88 DUE ORO



89 LINEA ORO

I modelli di queste pagine, sono già disponibili in magazzino nella versione Oro. Tutti gli altri modelli possono essere forniti in versione Oro, a richiesta, senza quantità minima

The models on this pages are already available in stock in the Gold version. All the other models can be supplied on request in the Gold version, without minimum quantity.

Les modèles des cettés pages sont déjà disponible en stock dans la version Oro. Tous les autres modèles peuvent être fournis en version Oro, sur demande, sans quantité minimum.

Die Modelle auf diesei Seiten sind Ausführungen in der Oro, Oberfläche auf Lager bereits. Alle anderen Modelle können auf Anfrage ohne Mindestmenge in der Oro-Version geliefert werden

Los modelos de estas páginas son ya disponible en el almacén en la versión Oro. Todos los otros modelos se pueden suministrar en la versión Oro, bajo pedido, sin cantidad mínima.

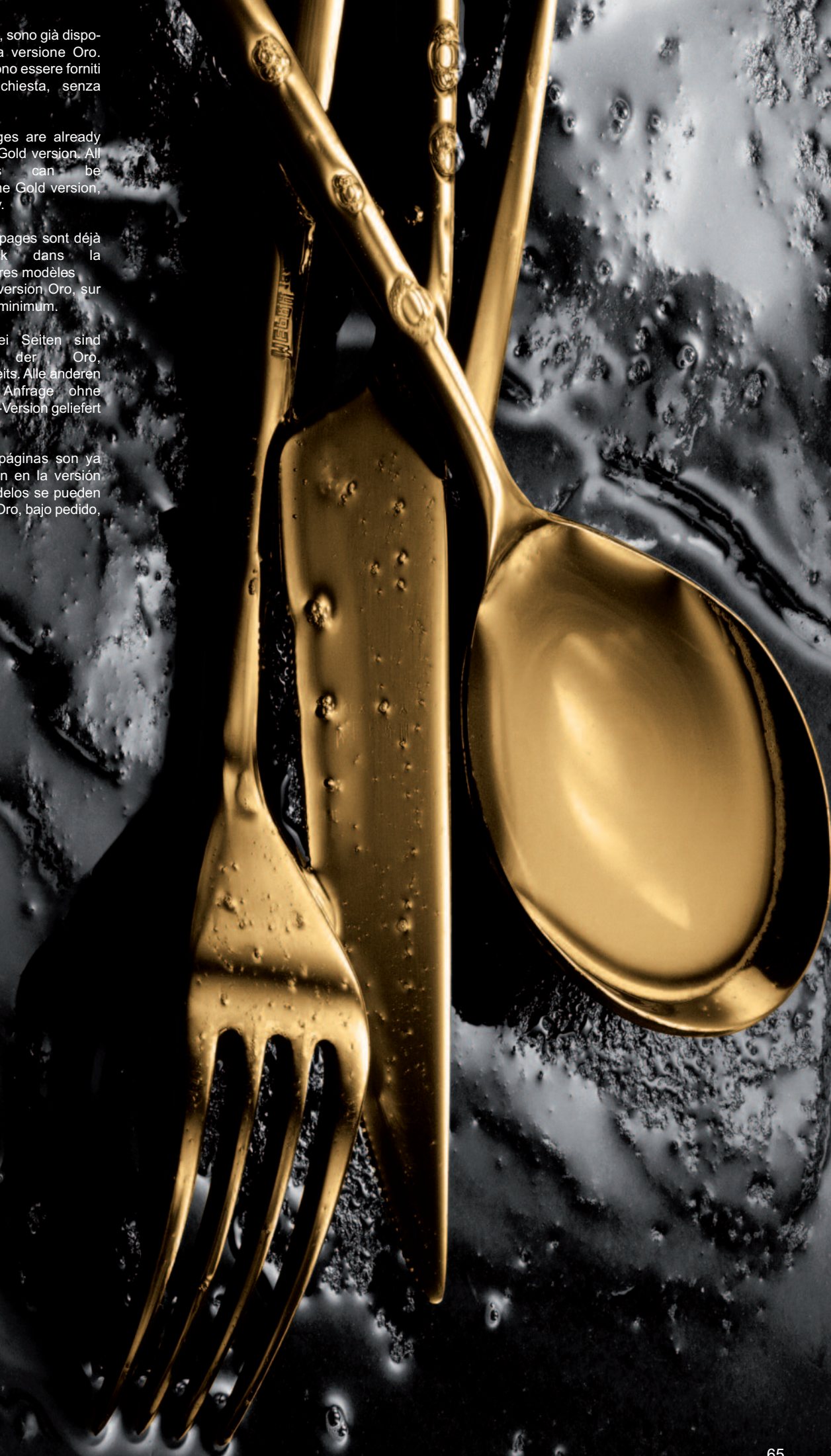



92 DUE CHAMPAGNE



86 DUE ORO NERO



93 LINEA CHAMPAGNE



87 LINEA ORO NERO





90 DUE BRONZO



80 DUE ICE ORO



91 LINEA BRONZO



81 LINEA ICE ORO



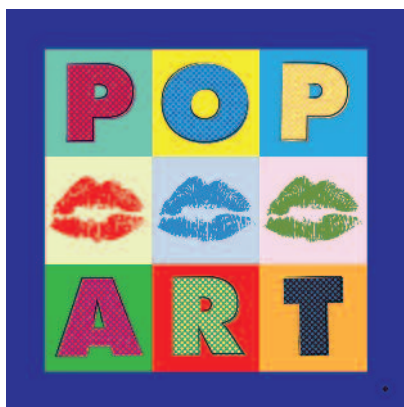

94 DUE ARCOBALENO



99 LINEA ARCOBALENO



Collezione





40

Mestolino per Salsa
Gravy ladle
Cuillère à sauce
Saucenöffel
Cacillo para salsaera

Si usa per servire
salse e condimenti
dalla salsiera
It is used to take sau-
ces and aromatic con-
diments from the gravy
boat.



16

Pala per Torta
Cake trowel
Pelle à tarte
Tortenheber
Pala tarta

Si usa per tagliare e
servire torte e semi-
freddi
It is used to portion
and serve cakes or
"semifreddi" (some
kinds of Italian ice-
cream).



09

Mestolo a servire
Ladle
Louche
Suppenshöpfer
Cazo Sopa

Si usa per servire mine-
stre dalla zuppiera al
piatto fondo
It's used to serve soups
from the tureen to the
(soup) plate.



01

Cucchiaino Tavola
Table spoon
Cuillère table
Tafellöffel
Cuchara de mesa

Cucchiaino per minestre e primi piatti
Spoon for soups and first courses



04

Cucchiaino Frutta
Dessert spoon
Cuillère à dessert
Dessertlöffel
Cuchara postre

Cucchiaino per dessert a base di crema e salse. Molto utile anche per la prima colazione
Spoon for cream or sweet sauce desserts, very helpful for breakfast too.



07

Cucchiaino Caffè
Tea spoon
Cuillère à café
Kaffeelöffel
Cuchara café

In realtà è un cucchiaino per tè e tisane, utilizzato anche per le zuccheriere e le formaggere. Dato i molteplici utilizzi, è sempre meglio possederne una mezza dozzina in più rispetto al resto della pezzeria.
This is just a tea or herbal tea spoon, but is also used with sugar bowls and cheese basins. For this reason, it is better to have half of a dozen more than the rest of the cutlery.



08

Cucchiaino Moka
Coffee spoon
Cuillère à moka
Mokkalöffel
Cucharita moka

Cucchiaino per caffè
This is a coffee spoon



10

Cucchiaino a servire
Cooking spoon
Cuillère à legumes/ à ragùt
Gemüselöffel
Cuchara legumbres

Si usa per servire sia primi piatti sia piatti principali. Buona regola possederne in quantità doppia rispetto al forchettone
It's used to serve first and main courses. It is better to have this cover twice than the cooking fork.



22

Cucchiaino Insalata
Salad serving spoon
Cuillère à salade servir
Salatvorlegelöffel
Cuchara servir ensalada

Si usa per mescolare e servire insalate, ma non solo: ottimo per servire antipasti a base di verdure e pesce. It is used to mix and serve salads, but is also very good to serve fish and vegetable hors-d'oeuvres.



23

Forchetta Insalata
Salad serving fork
Fourchette à salade servir
Salatvorlegegabel
Tenedor servir ensalada

Forchetta insalata
Si usa in coppia con
il cucchiaino insalata
Salad serving fork
It is used with the
salad spoon for serving.

25

Cucchiaino Bibita
Ice tea spoon
Cuillère à soda
Limonadenöffel
Cucharita refresco

Cucchiaino per
cocktail e gelati
con creme in
coppe profonde
Spoon used for
cocktails and ice-
creams served in
deep drinking-
glasses.

44

Cucchiaino Cappuccino
Cappuccino spoon
Cuillère à cappuccino
Cappuccinolöffel
Cucharita cappuccino

Cucchiaino per
cocktail e gelati
con creme in
coppe profonde
Spoon used for
cocktails and ice-
creams served in
deep drinking-
glasses.

39

Cucchiaino Gourmet
Gourmet spoon
Cuillère à degustation
Kostprobelöffel
Cuchara degustación

Cucchiaino per dolci
e pesce con salse.
La parte schiacciata
della tazza,
consente sia di tagliare
la pietanza,
che di raccoglierne
il sugo.
It's the spoon used
for cakes and fish
with sauce. The
crushed part of the
cup , allows both to
cut the course and
to collect the juice.

45

Cucchiaino Degustazione
French sauce spoon
Cuillère à sauce individuelle
Gourmetlöffel
Cuchara salsa gourmet

Paletta per pesce
con salse, adatta a
tagliare il pezzo ed
a raccoglierne la
salsa.
Scoop for fish with
sauces , used to
cut the piece and
to reap the sauce .

35

Cucchiaino Zuppa
Soup spoon
Cuillère à soupe
Tassenlöffel rund
Cuchara para sopa

Cucchiaino per con-
sommé, tipica
forma di cucchiaino
per minestre in
brodo della tradi-
zione inglese.
It's the consomme
spoon used for the
traditionals English
soups.

26

Cucchiaino americano
American coffee spoon
Cuillère pour enfant
Kinderlöffel
Cucharita bebè

Cucchiaino per il
caffè americano. il
cappuccino, la
prima colazione,
oppure per dessert
a base di creme e
salse.
Spoon used for
american coffee,
cappuccino , bre-
akfast or for des-
sert with cream
and sauces .



02

Forchetta Tavola
Table fork
Fourchette table
Tafelgabel
Tenedor de mesa

Forchetta per primi piatti e piatto principale. Dato che è il pezzo in assoluto più utile ed usato, è sempre meglio possederne in doppia quantità rispetto agli altri pezzi.
Fork for first and main courses. It's better to have this cover twice, because it is the most useful one.



05

Forchetta Frutta
Dessert fork
Fourchette à dessert
Dessertgabel
Tenedor postre

Forchetta per antipasto e per dessert a base di frutta. Utilizzata per sbaglio spesso anche per i dessert a base dolce.
Hors d'oeuvre fork used for fruit desserts, it is wrongly used for sweet desserts.



15

Forchettina Dolce
Cake fork
Fourchette à gateaux
Kuchengabel
Tenedor pastel

Forchetta per tutti i dolci e dessert, tranne quelli a base di frutta
Fork used only for cakes and sweet desserts, but not for fruit.



27

Forchettina Bebè
Baby fork
Fourchette pour enfant
Kindergabel
Tenedor bebè

Forchetta per bambini.
Fork for babies courses.



21

Forchetta Pesce da tavola
Table fish fork
Fourchette poisson table
Fischgabel
Tenedor pescado

Forchetta per pesce e molluschi
Fork for fishes and Mollusca



11

Forchettone a servire
Serving fork
Fourchette à legumes/ à servir
Fleischgabel
Tenedor legumbres

Si usa per servire sia primi piatti sia piatti principali.
It's used to serve first and main courses



03

Coltello Tavola
Table knife
Couteau table
Tafelmesser
Cuchillo de mesa

Coltello per piatto principale. Può essere in manico cavo, come le vecchie consigli in tavola in argento, leggero ed esclusivo; oppure in manico pieno prodotto con la tecnologia della forgiatura.

Table knife: Knife for main dishes with hollow handle, light and exclusive like the old fashioned silver covers or onepiece handle, made by the forging technology.



06

Coltello Frutta
Dessert knife
Couteau à dessert
Dessertmesser
Cuchillo postre

Coltello per antipasto e per dessert in combinazione con la forchetta frutta. Per qualità vale lo stesso discorso del coltello tavola

Used with the fruit fork in the hors-d'oeuvre and the fruit desserts. It's quality is the same of the table knife.



20

Paletta Pesce da tavola
Table fish knife
Couteau poisson table
Fischmesser
Cuchillo pescado

Coltello per tagliare pesce e molluschi
Knife used to slice fishes and Mollusca



28

Coltellino Bebè
Baby knife
Couteau pour enfant
Kindermesser
Cuchillo bebé

Coltellino per bambini.



36

Coltello Bistecca
Steak knife
Couteau à viande
Steakmesser
Cuchillo bistek

Coltello con lama profonda per bistecche di spessore.
Sharpedged blade knife helpful to cut substantial steaks



37

Coltello per burro
Butter knife
Couteau à beurre
Buttermesser
Cuchillo para mantequilla

Coltello per burro utilizzato per la prima colazione. Nella tradizione nordica ed inglese utilizzato sulla tavola in un piatto piano da frutta accanto al posto tavola, per spalmare il burro sul pane in occasione di lunch e dinner.
Butter cover used during breakfast. In England and in the North European countries during lunch or dinner it is put in a dish near the table set to spread butter on the bread.

Must Have

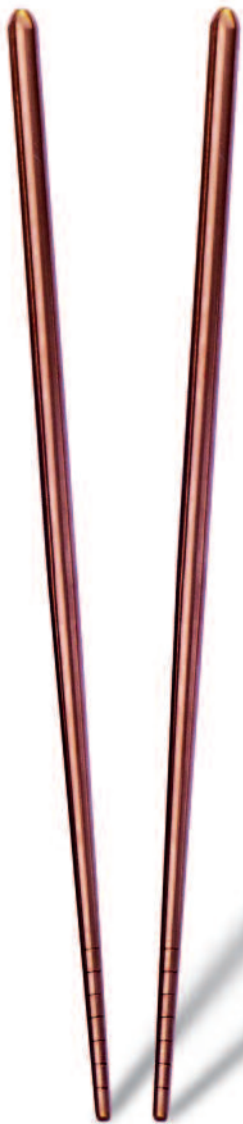

BRONZO
10001128B

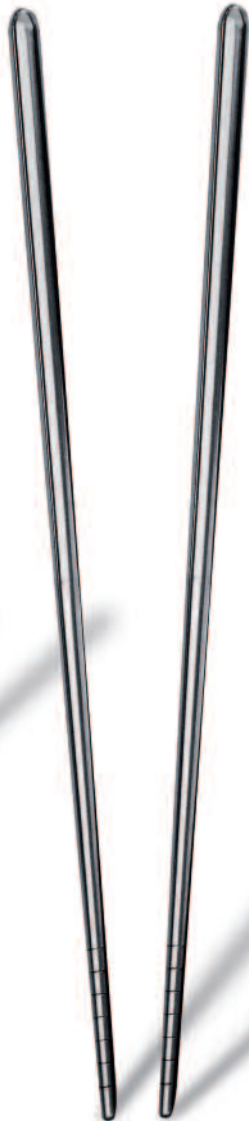

ACCIAIO
10001128



ORO NERO
10001128N



ORO
10001128O

ORO ICE
10001128OI



906
Appoggia chopstick
Chopstick rest
Porte chopstick
Ess-Stäbchen Ablage
Apoyo para chopstick

Largh. cm. 4,5
Width 1 3/4"

1128
Paia Chopsticks
Chopsticks set 2 pcs.
Paire de chopsticks
Ess-Stäbchen Paar
Chopsticks 2 pzas.

cm. 22,5
8 7/8"

CHOP STICKS





915
 Appoggia posate
 Knife rest
 Soutier p/couverts
 Besteck Ablage
 Apoyo p/cubiertos

Largh. cm. 6,5
 Width 2 1/2"



906
 Appoggia posate
 Knife rest
 Soutier p/couverts
 Besteck Ablage
 Apoyo p/cubiertos

Largh. cm. 4,5
 Width 1 3/4"



BRONZO
 10001175B



**ORO
 NERO**
 10001175ON



ACCIAIO
 10001175



ORO
 10001175O

ORO ICE
 10001175OI

1175
 Appoggia posate
 Knife rest
 Soutier p/couverts
 Besteck Ablage
 Apoyo p/cubiertos

Largh. cm. 6,5
 Width 2 1/2"

APPOGGIA POSATE





BRONZO
10001144B



ACCIAIO
10001144



ORO
NERO
10001144ON



ORO
10001144O
ORO ICE
10001144OI

1144
Coltello bistecca americano
American steak knife
Couteau entrecôte américain
Amerikanisches Steakmesser
Cuchillo bistek americano
cm. 25
9 5/8"

BISTECCA AMERICANO





UNI
10001136

Coltello bistecca
Steak knife
Couteau entrecôte
Steakmesser
Cuchillo bistek
cm. 21,3
8 1/4"

NORMA
10101136
BOHEME
10231136

Coltello bistecca
Steak knife
Couteau entrecôte
Steakmesser
Cuchillo bistek
cm. 23
9 1/8"

ROMA
10141136
NATURA
10341136
BRESCIA
1020B1136

Coltello bistecca
Steak knife
Couteau entrecôte
Steakmesser
Cuchillo bistek
cm. 22,7
8 7/8"

10701136
CARINZIA

Coltello bistecca
Steak knife
Couteau entrecôte
Steakmesser
Cuchillo bistek
cm. 23,1
9 1/9"

10711136
STOCCOLMA

Coltello bistecca
Steak knife
Couteau entrecôte
Steakmesser
Cuchillo bistek
cm. 23,1
9 1/9"

BISTECCA





THE GOOD DESIGN AWARDS 2016

As Awarded by The Chicago Athenaeum:
Museum of Architecture and Design



JRE
JEUNES RESTAURATEURS



Ci sono Chef nel mondo che emozionano attraverso il gusto. Uno di questi è Ferran Adrià, cui omaggiamo l'idea della Quarta Posata, ispirata dalla sua pinza per tapas, oggi cambiata e migliorata per usi nuovi a tavola, insieme ai JRE Italia. Cucchiaino, Forchetta, Coltello, Quarta Posata. Da oggi possiamo divertirci di più a tavola!



QUARTA POSATA





10001129
Quarta posata

Lungh. cm. 22,2
Length 8 3/4"





BRONZO
10001139B



ACCIAIO
10001139



ORO
NERO
10001139N



ORO
10001139O
ORO ICE
10001139OI

1139
Forchetta aragosta
Lobster fork
Curette à homard
Hummergabel
Tenedor langostas

cm. 19,4
7 ²/₃"

ARAGOSTA



NEW

NEW



BRONZO
10341146B



ACCIAIO
10341146



ORO
NERO
10341146ON



ORO
10341146O
ORO ICE
10341146OI

1146
Cucchiaio multifunzione
Multifunctional spoon
Cuillère multifonctionnelle
Multifunktionaler Löffel
Cuchara multifuncional

cm. 17,6
6 3/8"

MULTIFUNZIONE



NEW

NEW

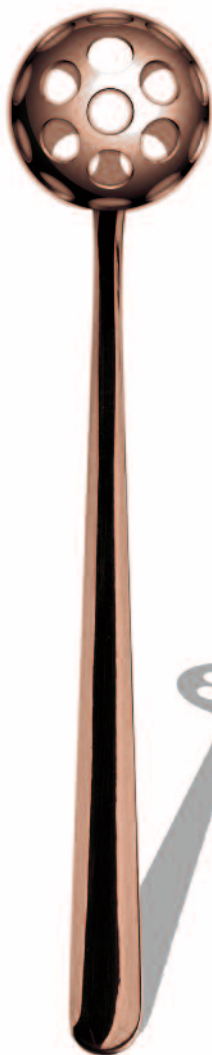

BRONZO
10001133B



ACCIAIO
10001133



ORO
NERO
10001133ON



ORO
10001133O
ORO ICE
10001133OI

1133
Cucchiaio per miele
Honey spoon
Cuillère à miel
Honiglöffel
Cuchara de miel

cm. 16
6 1/4"

MIELE





BRONZO
200727B



ORO
NERO
200727ON



ACCIAIO
200727



ORO
200727O

ORO ICE
200727OI

727
Coppa per intermezzo
Intermezzo cup
Coupe à intermezzo
Sorbetschale
Copa para intermezzo

cl. 4
oz. 1 ³/₈

INTERMEZZO



NEW

421

FASHION
Appoggia posate
Knife rest
Soutier p/couverts
Besteck Ablage
Apoyo p/cubiertos

cm. 12 x 8
4 3/4" x 3 1/7"

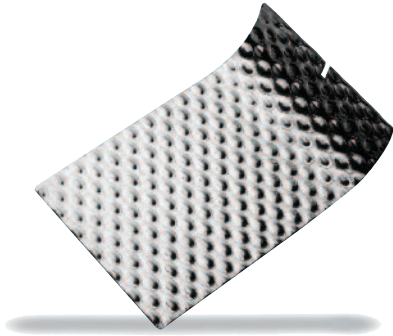

NEW

423

FASHION
Appoggia posate
Knife rest
Soutier p/couverts
Besteck Ablage
Apoyo p/cubiertos

cm. 11 x 3
4 1/3" x 1 1/5"



920

Appoggia posate
Knife rest
Soutier p/couverts
Besteck Ablage
Apoyo p/cubiertos

cm. 10 x 8
4" x 3 1/7"



NEW

424

GIOTTO
Appoggia posate
Knife rest
Soutier p/couverts
Besteck Ablage
Apoyo p/cubiertos

cm. 11 x 3
4 1/3" x 1 1/5"



740

Coppetta amouse bouche
Appetizer bowl
Bol multi-usages
Fingerfood-/Vorspeisen-/Butter-Gefäss
Cuenco para finger food/amouse bouche

cm. 13 x 7 - cl. 4
5 1/9" x 2 3/4" - oz. 4



10521131

Mini Forchetta
Appetizer fork
Fourchette amouse bouche
Minigabel
Mini tenedor

cm. 11,4
4 1/2"



10521108
Mini spoon

cm. 11,4
4 1/2"



750

Micro forchetta
Micro fork
Micro fourchette
Mikrogabel
Micro tenedor





ARAGOSTE



10001140
Pinza aragosta
Lobster pincers
Pince à homard
Hummerzange
Pinzalangostas
cm. 18,5
7 1/3"



10001139
Forchetta aragosta
Lobster fork
Fourchette langouste
Hummergabel
Tenedor langostas
cm. 19,4
7 2/3"



1020B1143
BRESCIA
Cucchiaio risotto
"Risotto" spoon
Cuillère "Risotto"
Reislöffel
Cuchara arroz seco
cm. 27,7
11"



10201144
Cucchiaino cappuccino
Cappuccino spoon
Cuillère cappuccino
Cappuccinolöffel
Cucharita cappuccino
cm. 16,5
6 1/2"

Modelli-Models
POSATE

ANTIPASTI



10001150
Golf club mixer spoon
Golf club mixer spoon
Golf crosse pour cocktail
Golf Schleger für Long drink
Golf club cucharita por coctél
cm. 16,5
6 1/2"

LUMACHE



779
Molla lumache
Escargot tongs
Pince escargots
Schneckenzange
Pinzas caracoles
cm. 15,6
6 1/4"



10001138
Forchetta lumache
Escargot fork
Fourchette escargots
Schnecken-gabel
Tenedor caracoles
cm. 14,9
5 7/8"

FORMAGGIO



10001147
Forchetta formaggio
Cheese fork
Fourchette fromage
Käsegabel
Tenedor queso
cm. 21
8 3/8"



10001125
Coltello formaggio
Cheese knife
Couteau fromage
Kaesemesser
Cuchillo queso
cm. 22
8 3/4"



10001126
Coltello parmigiano
Parmesan chesse knife
Couteau parmesan
Parmesanmesser
Cuchillo parmigiano
cm. 16,5
6 1/2"



10001109



cm. 22
8 5/8"

mm. 3,0

Mestolo
Ladle
Louche
Suppschöpfer
Cazo sopa

mm. 3,0



cm. 18,5
7 1/4"

10001116

Pala per torta
Cake trowel
Pelle à tarte
Tortenheber
Pala tarta

10001142



cm. 20,7
8 1/8"

mm. 3,0

Cucchiaione
da risotto
Spoon for "Risotto"
Cuillère à "Risotti"
Reislöffel
Cuchara para arroz seco

mm. 2,5



cm. 10,5
4 1/4"

10001115

Forchettina dolce
Cake fork
Fourchette à gateaux
Kuchengabel
Tenedor pastel

10001110



cm. 17,5
6 3/4"

mm. 3,0

Cucchiaione
Serving spoon
Cuillère à servir
Servierlöffel
Cuchara servir

mm. 3,0



cm. 15,5
6"

10001120

Paletta pesce tavola
Table fish knife
Couteau poisson
Fischmesser
Pala pescado

10001111



cm. 17
6 5/8"

mm. 3,0

Forchettone
Serving fork
Fourchette à servir
Serviergabel
Tenedor servir

mm. 3,0



cm. 15,5
6"

10001121

Forchetta pesce tavola
Table fish fork
Fourchette poisson
Fischgabel
Tenedor pescado

10001122



cm. 17
6 5/8"

mm. 3,0

Cucchiaio insalata
Salad serving spoon
Cuillère à salade
Salatvorlegelöffel
Cuchara para ensalada

mm. 3,0



cm. 12,5
4 7/8"

Happy spoon

10001141

10001123



cm. 17
6 5/8"

mm. 3,0

Forchetta insalata
Salad serving fork
Fourchette à salade
Salatvorlegegabel
Tenedor para ensalada

mm. 2,5



cm. 8,5
3 3/8"

10001124

Paletta gelato
Ice-cream spoon
Cuillère à glâce
Eislöffel
Cucharita helado

HAPPY



Fantasia



● Non ci si stanca mai del colore, soprattutto in ciò che ci circonda. Fantasia è un apostrofo funky tra le parole “Eleganza” e “Raffinatezza” di tutte le nostre collezioni. le posate sono realizzate in acciaio inossidabile 18/10 e da coloratissimi manici ad alta resistenza (hanno la stessa resistenza del legno, ma si possono lavare in lavastoviglie migliaia di volte).

● You never get tired of the color, especially in our surroundings. Fantasy is a funky apostrophe between the words "Elegance" and "Refinement" of all our collections. the cutlery are made of 18/10 stainless steel and highly coloured handles with high resistance (it has the same resistance of the wood, but it can be washed in the dishwasher thousands of times).

Fantasia è:

- Ultraresistente
- Lavabile in lavastoviglie
- Saldata ad ultrasuoni per una tenuta perfetta
- Acciaio inossidabile 18/10 ad elevato spessore
- Garantita a vita
- Ideale per:
- Pool & Pathio
- Spiagge
- Urban & Pop
- Ospedali
- Case di residenza per anziani
- Yacht
- Chalet
- Giardini
- Loft

Fantasia is:

- Ultra-resistant
- Dishwasher safe
- Ultrasonic welded for a perfect seal
- High thickness 18/10 Stainless steel
- Lifetime guaranteed
- Ideale for:
- Pool & Pathio
- Beaches
- Urban & Pop
- Hospitals
- Retirement homes
- Yacht
- Chalet
- Rooftop Gardens
- Loft





Mirror



O

ON

B

C

A

AR

Oro
Lucido

Oro Nero
Lucido

Bronzo
Lucido

Champagne
Lucido

Arcobaleno
Lucido

Argentato
Lucido



Ice



OI

ION

IB

IC

IA

ARI

Oro
Ice

Oro Nero
Ice

Bronzo
Ice

Champagne
Ice

Arcobaleno
Ice

Argentato
Ice



Peltro



PO

Oro
Peltro

PON

Oro Nero
Peltro

PB

Bronzo
Peltro

PC

Champagne
Peltro

PA

Arcobaleno
Peltro

PAR

Argentato
Peltro

COLORI DISPONIBILI



N
Nero
Black

I
Vigogna
Vicuna

W
Porcellana
China

M
Tabacco
Tobacco

S
Salvia
Sage

T
Tortora
Turte-dove

L
Vaniglia
Vanilla

D
Sesamo
Sesame

B7
Ciclamino
Light mauve

H7
Lilla
Lilac

P7
Rosa
Pink

Z7
Rosa pallido
Pale Rose

V
Verde
Green

A7
Mela verde
Apple Green

E
Verde acido
Acid Green

Q7
Verde oliva
Olive Green

AVAILABLE COLORS

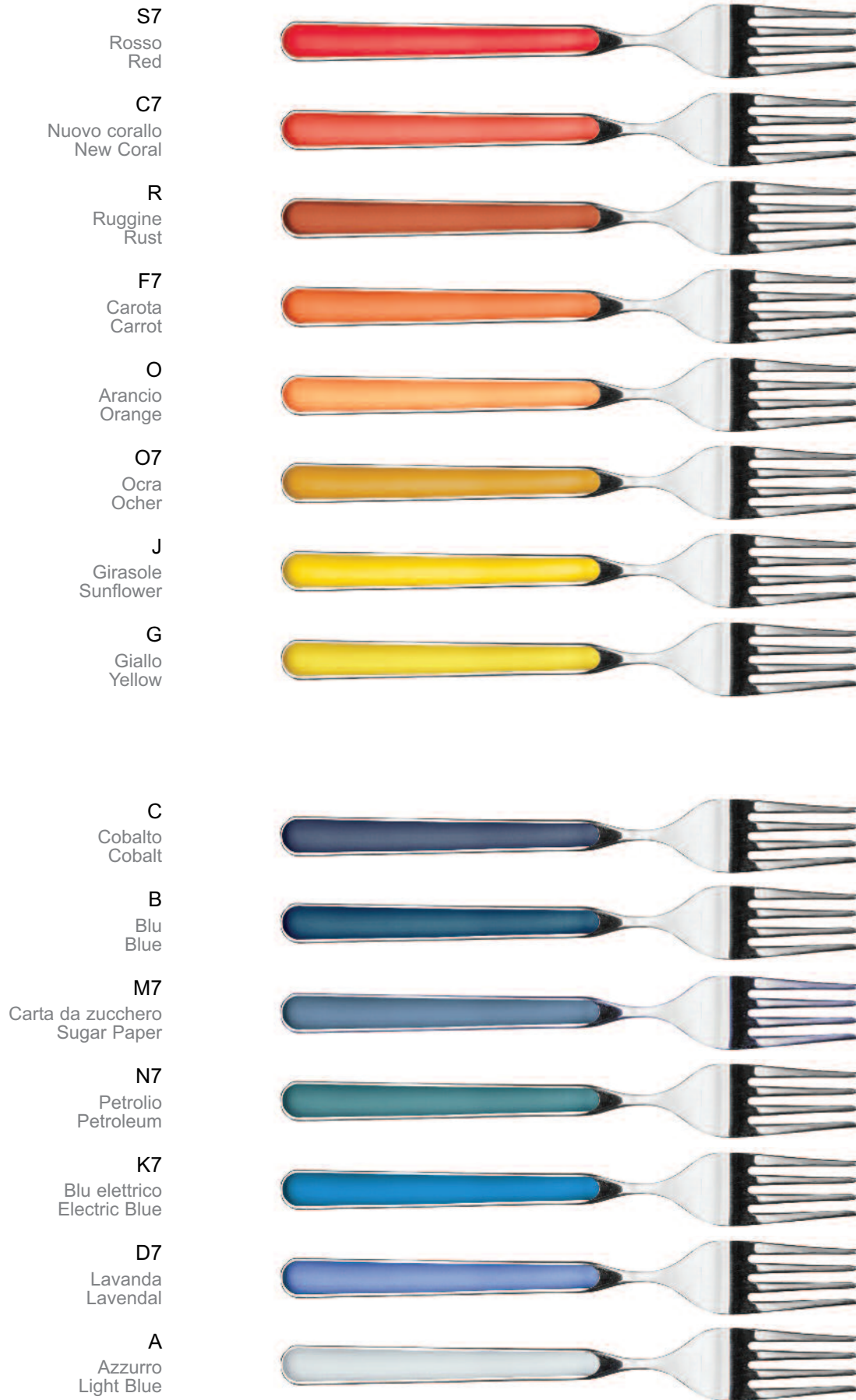

PEZZI DISPONIBILI

10(color)1101

Cucchiaio tavola
Table spoon



Lunghezza 197 mm
Length 7 3/4"

10(color)1102

Forchetta tavola
Table fork



Lunghezza 197 mm
Length 7 3/4"

10(color)1103

Coltello tavola
Table knife



Lunghezza 223 mm
Length 8 3/4"

10(color)1104

Cucchiaio frutta
Dessert spoon



Lunghezza 174 mm
Length 6 7/8"

10(color)1105

Forchetta frutta
Dessert fork



Lunghezza 175 mm
Length 6 8/9"

10(color)1106

Coltello frutta
Dessert knife



Lunghezza 197 mm
Length 7 3/4"

10(color)1107

Cucchiaino caffè
Tea spoon



Lunghezza 133 mm
Length 5 1/4"

10(color)1115

Forchettina dolce
Cake fork



Lunghezza 157 mm
Length 6 1/5"

10(color)1126

Cucchiaino caffè americano
American size coffee spoon



Lunghezza 156 mm
Length 6 1/7"

10(color)1116

Pala per torta
Cake trowel



Lunghezza 254 mm
Length 10"

AVAILABLE RANGE

10(color)1122

Cucchiaio insalata a servire
Salad serving spoon



Lunghezza 233 mm
Length 9 1/6"

10(color)1123

Forchetta insalata a servire
Salad serving fork



Lunghezza 233 mm
Length 9 1/6"

10(color)1110

Cucchiaione
Serving spoon



Lunghezza 235 mm
Length 9 1/4"

10(color)1111

Forchettone
Carving fork



Lunghezza 235 mm
Length 9 1/4"

10(color)1140

Mestolino per salsiera
Gravy ladle



Lunghezza 185 mm
Length 7 1/4"

10(color)1120

Paletta pesce da tavola
Table fish knife



Lunghezza 198 mm
Length 7 4/5"

10(color)1121

Forchetta pesce da tavola
Table fish fork



Lunghezza 195 mm
Length 7 2/3"

10(color)1143

Cucchiaone da risotto
Rice spoon



Lunghezza 277 mm
Length 10 8/9"

10(color)1142

Forchetta per fonduta
Fondue fork



Lunghezza 290 mm
Length 11 2/5"

Vasellame



HOLLOWARE
MATERIEL DE SERVICE
ACCESSOIRES
ORFEBRERIA

- Gamma completa per tutti gli usi
- Spessore elevato
- Doppia saldatura manici, alta resistenza
- Beccucci rompigoccia
- Prodotti impilabili salvaspazio
- Criterio di progettazione di ogni prodotto accuratamente studiato per il quotidiano uso nel settore alberghiero.
- Each collection offers an extensive range of different items.
- Thicker stainless steel.
- Double welded handles offer durability.
- Drip-less spouts on all pitchers, creamers, coffee and tea pots.
- Space saving stackable items.
- Hospitality grade and professional quality

MEPRA
S.p.A.

- Gamme complète pour tous les us
- Épaisseur massives
- Soudures manches haute résistance
- Becs rompigoutes
- Articles empilables pour sauver space
- Critère de projet de chaque produit est étudié pour l'usage quotidien soigneusement dans le secteur hôtelier

- Ein vollständiges Sortiment für jeden Gebrauch
- Hohe Materialstärke
- Doppelt geschweisste
- Handgriffe, hohe Widerstandsfähigkeit
- Kein Tropfen beim Ausgießen
- Stapelbar und platzsparend
- Jedes Produkt ist genaustens für den täglichen
- Gebrauch in der Spitzengastronomie und -hotellerie gestaltet

- Gamma completa para todos los usos.
- Espesor macizo
- Mango soldado de alta resistencia.
- Vertedor rompe gotas
- Producto apilable ahorra espacio
- Criterio de diseño de cada producto estudiado minuciosamente para el uso cotidiano en el sector hostelero.

MEPRA
S.p.A.





Carbon Fiber



14270

ANNIE

Vassoio in carbonio

Carbon fiber tray

Plateau en fibre de carbone

Kohlefaser-Tablett

Bandeja de fibra de carbono

cm. 72 x 50

28 1/3" x 19 3/4"





Atmosfera

La collezione ATMOSFERA è realizzata in acciaio inossidabile 18/10 con un trattamento di verniciatura in polvere. Oltre alla collezione ATMOSFERA, possiamo realizzare tutto il vasellame di questo catalogo nei tre colori:

The ATMOSFERA collection is made of 18/10 stainless steel with a powder coating treatment. In addition to the collection ATMOSFERA, we can make all the tableware of this catalog in the three colors:

La collection ATMOSFERA est réalisée en acier inoxydable 18/10 avec un traitement de revêtement en poudre. En plus de la collection ATMOSFERA, nous pouvons faire toute la vaisselle de ce catalogue dans les trois couleurs:

Die ATMOSFERA Kollektion besteht aus 18/10 Rostfreie Stahl mit einer Behandlung von pulverförmig. Zusätzlich der Kollektion ATMOSFERA, können wir dieses Katalog in den drei Farben machen:

La colección ATMOSFERA está hecha de acero inoxidable 18/10 con un tratamiento de recubrimiento en polvo. Además de la colección ATMOSFERA, podemos realizar toda la orfebrería de este catálogo en los tres colores:



O
Materic Gold



N
Vulcan Grey



B
Materic Bronze

1016



mm. 1,2
MERCURIO
Cestino
Basket
Corbeille
Früchtekorb
Cesta
Ø cm. 11 Ø 4 3/8"
H cm. 12,5 H 4 7/8"
cl. 55 oz. 18 5/8

1017



mm. 1,2
Ø cm. 19 Ø 7 1/2"
H cm. 20 H 7 3/4"
Lt. 2,5 Lt. 8 oz. 84 1/2

669MG



mm. 1,2

Cestino
Basket
Corbeille
Früchtekorb
Cesta

Ø cm 14
H cm 13,5
lt. 0,70

Ø 5 2/3"
H 5 1/8"
oz. 23 2/3

668MG



mm. 1,2

Secchiello per spumante
Sparkling wine cooler
Seau à champagne
Wein- und Sektkühler
Cubo para champany

Ø cm 24
H cm 23
lt. 2,75

Ø 9 1/2"
H 9"
oz. 93

666MG



mm. 1,2

Colonna portasecchiello
Wine cooler stand
Pied pour seau à champagne
Weinkühlerständer
Columna porta cubo champany

H cm. 65 H 25 5/8"

727MG



mm. 1,2

Coppa per intermezzo
Intermezzo cup
Coupe à intermezzo
Sorbetschale
Copa para intermezzo

H cm 8,3
cl. 4

H 3 1/4"
oz. 1 3/8



1011

1014



mm. 1,2

GIOVE
Cestino
Basket
Corbeille
Früchtekorb
Cesta

1011
cm. 16,6 x 10
H cm. 14,2
cl. 180
6 1/2" X 4"
H 5 3/5"
oz. 60 7/8

1014
cm. 27 x 20,5
H cm. 21,5
Lt. 6,5
10 5/8" X 8"
H 8 1/2"
gal. 1 3/4

1013

1012



mm. 1,2

MARTE
Cestino
Basket
Corbeille
Früchtekorb
Cesta

1013
Ø cm. 29
H cm. 18,5
Lt. 8
Ø 11 3/8"
H 7 1/4"
gal. 2

1012
Ø cm. 16,8
H cm. 11
cl. 150
Ø 6 5/8"
H 4 3/8"
oz. 50 3/4

666HMG



mm. 1,2

Colonna portasecchiello spumante
Wine cooler stand
Pied pour seau à champagne
Weinkühlerständer
Columna porta cubo champany

H cm. 61,5
H 24 1/5"

666CMG



mm. 1,2

Colonna portasecchiello spumante
Wine cooler stand
Pied pour seau à champagne
Weinkühlerständer
Columna porta cubo champany

H cm. 67,5
H 26 5/8"

1009

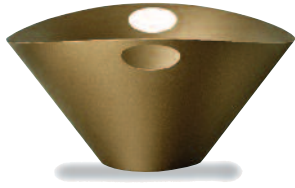

mm. 1,2

VENERE
Cestino
Basket
Corbeille
Früchtekorb
Cesta

cm. 22 x 20
H cm. 11,5
Lt. 1,2

8 5/8" x 7 7/8"
H 4 5/8"
oz. 40 1/2

1010



mm. 1,2

VENERE
Cestino
Basket
Corbeille
Früchtekorb
Cesta

cm. 39 x 36
H cm. 17,5
Lt. 7

15 3/8" x 14 1/4"
H 7"
gal. 1 4/5



1001



mm. 1,2 SATURNO
Piano
Tray
Plateau
Tablett oval
Bandeja

cm. 40 x 36 15 3/4" x 14 1/8"

1006



mm. 1,2 SATURNO
Piano
Tray
Plateau
Tablett oval
Bandeja

cm. 22 x 20 8 5/8" x 7 7/8"

1003



mm. 1,2 SATURNO
Piano
Tray
Plateau
Tablett oval
Bandeja

cm. 34 x 31 13 3/8" x 12 1/4"

1004



mm. 1,2 SATURNO
Piano
Tray
Plateau
Tablett oval
Bandeja

cm. 14 x 12 5 1/2" x 4 3/4"

1002



mm. 1,2 NETTUNO
Cestino
Basket
Corbeille
Früchtekorb
Cesta

100222
cm. 22 x 20
cl. 100

100240
cm. 40 x 36
cl. 200

100222
8 5/8" x 7 7/8"
OZ. 33 7/8

100240
15 3/4" x 14 1/8"
OZ. 67 5/8

1005

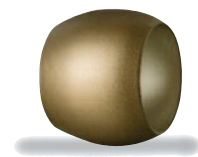

mm. 1,2 PLUTONE
Allacciatovaglioli
Napkins ring
Rond de serviette
Serviettenring
Servilletero

Ø cm. 6 Ø 2 3/8"



Sushic



787



787

TRE
Vassoio per prima colazione
Breakfast tray
Plateau rect. pour le petit déjeuner
Frühstück Tablett, rechteckig
Bandeja rect. por desayuno

cm. 50 x 32 27 1/2" x 12 5/8"

791AC



NEW

155



NEW

163



Inserto Finger Food per vassoio quadro e rettangolare
Finger Food insert for square and rectangular tray
Insért Finger Food pour plateau carré et rectangulaire
Finger Food-Einsatz für quadratische/rechteckig Schale
Inserto para Finger Food por bandeja cuadrada y rectangular
mm. 1,2

cm. 30 x 30

11 7/8" x 11 7/8"

Porta noccioli
Kernel holder
Porte noyaux
Aderhalter
Porta granos
mm. 1,2

Ø cm. 6

H cm. 5

cl. 5

Ø 2 2/5"

H 2"

oz. 1 3/4

TRE
Set per aperitivi
Appetizer set
Set pour Amouse bouche
Vorspeisen Set
Set para aperitivos

cm. 22 x 22
cl. 30

8 5/8" x 8 5/8"
oz. 10 1/8

793



TRE
Completo oliera con spargisale
Cruet and salt cellar set
Huile-vinaigre 4 pcs
Essig-/Öl-Menage 4-Tlg.
Vinagreras con saleros

cm. 15 x 15

H cm. 19,6

cl. 30 (x2)

cl. 8 (x2)

6" x 6"

H 7 3/4"

oz. 10 1/8 (x2)

oz. 2 3/4 (x2)

TRE
Formaggera
Parmesan cheese basin
Fromagère
Käsedose
Quesera Azucarero

cm. 15 x 15

cl. 20

6" x 6"

oz. 6 3/4

794



792



TRE
Vassoio rettangolare
Rectangular tray
Plateau rectangulaire
Tablett, rechteckig
Bandeja rectangular

cm. 50 x 32 19 3/4" X 12 3/4"
cm. 30 x 20 11 3/4" X 7 7/8"

788



QUATTRO
Vassoio rettangolare
Rectangular tray
Plateau rectangulaire
Tablett, rechteckig
Bandeja rectangular

cm. 50 x 32 19 3/4" X 12 3/4"
cm. 30 x 20 11 3/4" X 7 7/8"

791



TRE
Vassoio/Sottopiatto
Square Tray/Charger
Plateau/Assiette de bienvenue
Tablett/Platzteller,
Bandeja/Bajo plato

cm. 32 x 32 12 3/4" x 12 3/4"

789



QUATTRO
Vassoio/Sottopiatto
Square Tray/Charger
Plateau/Assiette de bienvenue
Tablett/Platzteller,
Bandeja/Bajo plato

cm. 32 x 32 12 3/4" x 12 3/4"

795



TRE
Tovaglietta americana
Place mat
Set de table
americain en bois
Tischset aus Holz
individual en madera

cm. 38 x 28 15" x 11"

796



TRE
Sottopiatto
Charger
Assiette de bienvenue
Platzteller
Bajo plato

Ø cm. 33 Ø 13"

804



TRE
Portacondimenti
Basket for aromatic condiments
Corbeille pour aromatiques condiments
Tisch-Essig/Öl-Flaschenhalter
Cesto para aromaticos y condimentos

cm. 15 x 15 6" x 6"
H cm. 19,6 H 7 3/4"

797



TRE
Cestino quadrato
Square basket
Corbeille carré
Schale, eckig
Panera cuadrada

cm. 15 x 15 6" x 6"
cm. 20 x 20 7 7/8" x 7 7/8"

599

58928

7 colori disponibili - pag. 310 - 311
7 colors available - pageS 310 - 311
7 couleurs disponibles - pag. 310 - 311
7 verschiedenen Farben verfügbar - Seiten 310 - 311
7 colores disponibles - pag. 310 - 311

589 - Ø cm. 28
Ø 11"



mm. 1,2

UNO
Cestino traforato
Fretworked basket
Corbeille, ajourée
Früchtekorb gelocht
Cesta perforada

Ø cm. 29 Ø 11 3/8"
H cm. 18,5 H 7 1/4"
lt. 8 gal. 2

666B

Disponibile in color
Available in walnut
Disponible en couleur
In Wengè und Walnuss
Disponible en color

noce e wengè
and wengè color
noyer et wengè
Farbe verfügbar
nuez y wengè



TRE
Colonna portasecchiello
Wine cooler stand
Pied pour seau à champagne
Weinkühlerständer
Columna porta cubo champany

H cm. 65 H 25 5/8"



A Noce
Walnut
Noyer
Walnuss
Nuez

R Rovere
Oak
Chêne
Eiche
Roble

W Wengé





3504

3404

S7



S7



BARCELONA

J



J



Ø cm. 12,5

Ø 5"

cm. 14 x 14

5 1/2" x 5 1/2"

3503

3403

F7



F7



AMSTERDAM

N7



N7



Ø cm. 12,5

Ø 5"

cm. 14 x 14

5 1/2" x 5 1/2"

3505

3405

H7



H7



BERLIN

Q7



Q7

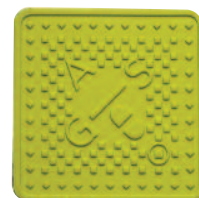

Ø cm. 12,5

Ø 5"

cm. 14 x 14

5 1/2" x 5 1/2"



3200

S7



3100
3600

S7



ROMA

S7



3300

J

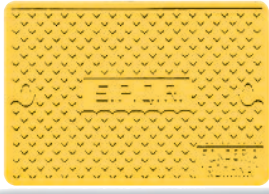

cm. 30 x 45

11 3/4" x 17 3/4"

3100
3600

J



3100 Ø cm. 17 Ø 6 3/4"
3600 Ø cm. 35 Ø 13 7/8"

J



cm. 45 x 45

17 3/4" x 17 3/4"

3202

F7



3102
3602

F7



LONDON

F7



3302

N7



3102 Ø cm. 17 Ø 6 3/4"
3602 Ø cm. 35 Ø 13 7/8"

N7



cm. 45 x 45

17 3/4" x 17 3/4"

3201

H7



3101
3601

H7



PARIS

H7



3301

Q7



cm. 30 x 45

11 3/4" x 17 3/4"

3101
3601

Q7



3101 Ø cm. 17 Ø 6 3/4"
3601 Ø cm. 35 Ø 13 7/8"

Q7



cm. 45 x 45

17 3/4" x 17 3/4"

Original Vintage



Gli articoli di queste pagine, sono già disponibili in magazzino nella versione antichizzata, PELTRO. Tutti gli altri articoli possono essere forniti in versione PELTRO, a richiesta, senza quantità minima

The items on these pages are already available in stock in the antiqued PELTRO version. All the other items can be supplied on request in the PELTRO version, without minimum quantity.

Les articles des cettis pages sont déjà disponible en stock dans la version avec la surface vieillie, PELTRO. Tous les autres articles peuvent être fournis en version PELTRO, sur demande, sans quantité minimum.

Die Artikeln auf diese Seiten sind Ausführungen in der antiken, Oberfläche PELTRO auf Lager bereits. Alle anderen Artikeln können auf Anfrage ohne Mindestmenge in der PELTRO-Version geliefert werden

Los artículos de estas páginas son ya disponibles en el almacén en la versión PELTRO, con la superficie envejecida. Todos los otros artículos se pueden suministrar en la versión PELTRO, bajo pedido, sin cantidad mínima.



187

186



Portauovo
Egg-cup
Coquetier
Eierbecher
Huevera
mm. 1,2

cm. 15 x 9
5 7/8" x 3 1/2"



Mini burriera
Mini Butter dish
Mini Beurrier
Mini Butterdose mit
Deckel
Mini Mantequera
mm. 1,2

cm. 12 x 6
cl. 15
4 3/4" x 2"
oz. 6

184

178



Salsiera
Gravy boat
Saucière
Saucière
Salsera
mm. 1,2

cl. 30
oz. 10 1/8



Saucière
cl. 4
oz. 1 3/8
mm. 1,2

173

177



Piatto ovale da portata pesce
bordo rinforzato
Oval serving fish plate
with reinforced edges
Plat à poisson oval bord renforcé
Fischplatte, oval
Fuente pescado borde reforzado
mm. 1,2

cm. 55 x 24
cm. 70 x 29
21 5/8" x 9 1/2"
27 1/2" x 11 3/8"



Piatto ovale da portata
bordo rinforzato
Oval serving plate
with reinforced edges
Plat oval bord renforcé
Bratenplatte, oval
Fuente ovalada borde reforzado
mm. 1,2

cm. 30 x 21
cm. 40 x 27
cm. 50 x 35
11 3/4" x 8 1/4"
15 3/4" x 10 5/8"
27 1/2" x 11 3/8"

172



Vassoio rettangolare per
pasticceria
Rectangular tray for cakes
Plat à tarte rectangulaire
Gebäckplatte, rechteckig
Bandeja
mm. 0,6

cm. 26 x 19
cm. 31 x 21
10 1/4" x 7 1/2"
12 1/4" x 8 1/4"

182

174



Vassoio per gratin
Tray for "gratin"
Plat à "gratin"
Gratinplatte
Bandeja gratinar
mm. 1,2

cm. 35 x 20
cm. 40 x 24
13 3/4" x 7 1/8"
15 3/4" x 9 1/2"

181



Vassoio per gratin e gastronomia
Tray for "Gratin-gastronomy"
Plat à "Gratin et gastronomie"
Gratinplatte für Gastronomie
Bandeja para gratinar y gastronomia
mm. 1,2

cm. 30 x 22
cm. 40 x 29
11 3/4" x 8 5/8"
15 3/4" x 11 3/8"



Piatto rotondo da portata
bordo rinforzato
Round serving plate
with reinforced edges
Plat rond de service bord
renforcé
Bratenplatte, rund
Bandeja redonda borde
reforzado
mm. 1,2

Ø cm. 27
Ø cm. 35
Ø cm. 40
Ø 10 5/8"
Ø 13 3/4"
Ø 15 3/4"



171



Cestino semitraforato
Half fretworked basket
Corbeille demi-ajouré
Schale, halbgelocht
Frutero semiperforado

Ø cm. 22 Ø 8 5/8"
H cm. 5,7 H 2 1/4"
cl. 150 oz. 50 1/4

mm. 0,8

170



Cestino traforato
Fretworked basket
Corbeille ajouré
Schale, gelocht
Frutero perforado

Ø cm. 22 Ø 8 5/8"
H cm. 5,7 H 2 1/4"
cl. 150 oz. 50 1/4

mm. 0,8

880



Scodella lavadita
Finger bowl
Ecuelle
Fingerbowl
Lavadedos

Ø cm. 12 Ø 4 3/4"
cl. 30 oz. 10 1/8

mm. 0,6

175



Piatto tondo per legumi a 3 scompi.
3 sections vegetable dish
Plat à légumes rond - 3 compt.
Teller rund 3 Abteilungen
Bandeja para legumbres 3 comp.

Ø cm. 27 Ø 10 5/8"

mm. 0,8

176



Piatto ovale per legumi a 2 scompi.
2 section vegetable dish
Plat à légumes oval - 2 comp.
Teller oval, 2 Abteilungen
Bandeja para legumbres 2 comp.

cm. 30 x 21
11 3/4" x 8 1/4"

mm. 0,8

874



Sottopiatto
Charger
Assiette de bienvenue
Platzteller
Bajo plato

Ø cm. 33
Ø 13"

mm. 1,2

185



Ciotola con base
Bowl with base
Bol avec socle
Obstschale auf Fuss
Cuenco con pedestal
mm. 1,2

Ø cm. 14 - cl. 60 Ø 5 1/2" - oz. 20 1/2
H cm. 8,8 H 3 1/2"
Ø cm. 20 - lt. 1,8 Ø 7 7/8" - oz. 60 7/8
H cm. 11 H 4 1/2"
Ø cm. 24 - lt. 3,1 Ø 11" - oz. 104 7/8
H cm. 14 H 6 1/3"

882



Secchio per ghiaccio
Ice bucket with grill
Seau à glaçons
Eisgefäß
Cubitera hielo
mm. 1,2

Ø cm. 14 Ø 5 1/2"
H.cm.13 H 5 1/8"
cl. 150 oz. 50 3/4

884



Secchio per spumante
Sparkling wine cooler
Seau à champagne
Wein-und Sektkühler
Cubo para champany
mm. 1,2

Ø cm.23 Ø 9"
H cm.22,5 H 8 7/8"
lt. 8,5 gal. 2 1/4

188

180

881

179



Tegamino friggiuova
Frying pan for eggs
Plat à oeuf
Eierpfanne
Plato huevos

Ø cm. 16

Ø 6 1/4"

mm. 0,8

Coppa per gelato
Ice-cream bowl
Coupe à glace
Eisschale
Copa helado

Ø cm. 8,5
cl. 15

Ø 3 1/3"
oz. 5

mm. 0,6

Molla per arrosto e verdure
Roasts and vegetables tongs
Pince à salade et à rôti
Servierzange
Pinzas asado y verduras

cm. 21

8 1/4"

mm. 0,8

Molla per spaghetti
Spaghetti/Pasta tongs
Pince à spaghetti
Spaghettizange
Pinzas spaghetti

cm. 21

8 1/4"

mm. 0,6

87504

87508



mm. 1,2

Bricco
Jug
Cruche
Milchkanne
Jarra

Tazze 4 cl. 40
Cups 8 cl. 70
Bols
Tassen
Tazas

13 1/2 oz.
23 5/8 oz.

mm. 1,2

Bricco
Jug
Cruche
Milchkanne
Jarra

Tazze 4 cl. 40
Cups 8 cl. 70
Bols
Tassen
Tazas

13 1/2 oz.
23 5/8 oz.

879

878



mm. 1,2

Bricco
Jug
Cruche
Milchkanne
Jarra

Tazze 2 cl. 25
Cups
Bols
Tassen
Tazas

8 1/2 oz.

mm. 1,2

Zuccheriera
Sugar bowl
Sucrier
Zuckerdose
Azucarero

Tazze 8 cl. 30
Cups
Bols
Tassen
Tazas

10 1/8 oz.



Tendence

609



mm. 1,2
Piano
Tray
Plateau
Tablett oval
Bandeja

cm. 40 x 36 15 3/4" x 14 1/8"

612



mm. 1,2
Piano forato
Tray fretworked handles
Plateau avec anses ajourée
Grifftablett oval
Bandeja asa perforada

cm. 40 x 36 15 3/4" x 14 1/8"

613



mm. 1,2
Fondo
Bowl
Bol
Brotschale oval
Cuenco

cm. 22 x 20 8 5/8" x 7 7/8"
cl. 80 oz. 27

cm. 40 x 36 15 3/4" x 14 1/8"
lt. 4,0 gal. 1

614



mm. 1,2
Fondo forato
Bowl fretworked handles
Bol avec anses ajourée
Griffschale oval
Cuenco asa perforada

cm. 22 x 20 8 5/8" x 7 7/8"
cl. 49 oz. 16 1/2

cm. 40 x 36 15 3/4" x 14 1/8"
lt. 2,6 oz. 87 7/8

617



mm. 1,2
Sottopiatto ovale
Charger oval
Assiette de bienvenue ovale
Platzteller oval
Bajo plato oval

cm. 34 x 31 13 3/8" x 12 1/4"
cm. 39 x 36 15 3/8" x 14 1/8"

616AC



mm. 1,2
Piattino per pane
Bread tray
Plat pour pan
Brot Platte
Plato para pan

cm. 14 x 12 5 1/2" x 4 3/4"

561



mm. 1,2 Rettangolare piano
Rectangular tray
Plateau rectangulaire
Tablett, rechteckig
Bandeja rectangular

cm. 23 x 13 9" x 5 1/8"
cm. 38 x 25 15" x 9 7/8"

562



mm. 1,2 Rettangolare fondo
Rectangular bowl
Bol rectangulaire
Obstschale, rechteckig
Cuenco rectangular

cm. 38 x 25 15" x 9 7/8"
H cm. 5,1 H 2"
cl. 300 oz. 101 1/2

557



mm. 1,2 Ovale piano
Oval tray
Plateau, oval
Tablett, oval
Bandeja oval

cm. 37 x 25 14 1/2" x 9 7/8"
cm. 46 x 31 18 1/8" x 12 1/4"

558



mm. 1,2 Ovale fondo
Oval bowl
Bol oval
Obstschale, oval
Cuenco oval

cm. 37 x 25 14 1/2" x 9 7/8"
H cm. 6,3 H 2 1/2"
cl. 250 oz 84 1/2
cm. 46 x 31 18 1/8" x 12 1/4"
H cm. 6,3 H 2 1/2"
cl. 400 gal. 1

563



mm. 1,2 Quadro piano
Square tray
Plateau carré
Tablett, quadratisch
Bandeja cuadrada

cm. 15 x 15 5 7/8" x 5 7/8"
cm. 22 x 22 8 5/8" x 8 5/8"

564

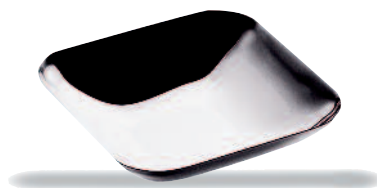

mm. 1,2 Quadro fondo
Square bowl
Bol carré
Schale, quadratisch
Cuenco cuadrado

cm. 15 x 15 5 7/8" x 5 7/8"
H cm. 4,9 H 2"
cl. 50 oz. 16 7/8
cm. 22 x 22 8 5/8" x 8 5/8"
H cm. 4,9 H 2"
cl. 150 oz. 50 3/4

559



mm. 1,2 Tondo piano Ø cm. 12 Ø 4 3/4 "
 Wine bottle coaster
 Plateau ronde
 Tablett rund
 Bandeja redonda

560



mm. 1,2 Tondo fondo Ø cm. 12 cl. 26 Ø 4 3/4" oz. 8 3/4
 Round bowl H cm. 3,9 H 1 1/2"
 Bol ronde Ø cm. 15 cl. 60 Ø 5 7/8" oz. 20 1/4
 Obstschale, rund H cm. 5 H 2"
 Cuenco redondo Ø cm. 22 cl. 131 Ø 8 5/8" oz. 44 1/3
 H cm. 5,8 H 2 1/4"
 Ø cm. 32 lt. 3,0 Ø 12 5/8" oz. 101 2/5
 H cm. 6,8 H 2 2/3"

568

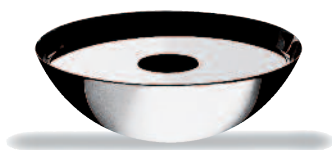

mm. 1,2 Posacenere ad acqua Ø cm. 12 Ø 4 3/4 "
 Water ashtray cl. 26 oz 8 4/5
 Cendrier à eau
 Wasserасher rund
 Cenicero ad agua

569



mm. 1,2 Posacenere ad acqua cm. 15 x 15 5 7/8" x 5 7/8"
 Water ashtray cl. 50 oz 16 7/8
 Cendrier à eau
 Wasserасher quadrat.
 Cenicero ad agua

567



mm. 1,2 Sottopiatto cm. 32 x 32 12 5/8" x 12 5/8"
 Charger
 Assiette de bienvenue
 Platzteller
 Bajo plato

870



mm. 1,2 GIOTTO cm. 35,5 x 11 14" x 4 1/3"
 Portapanne / Portagrissini
 Bread / Bread sticks holder
 Porte pan / Porte gressini
 Brot und-Grissini -Schale
 Portapan / Porta bastoncillos de pan

596

599



608

mm. 1,2 Cestini traforati
Fretworked baskets
Corbeilles, ajourées
Früchtekorb gelocht
Cestas perforadas

596
Ø cm. 16,8
H cm. 11
cl. 150

Ø 6 5/8"
H 4 3/8"
oz. 50 3/4

608
Ø cm. 27
H cm. 13,5
lt. 5

Ø 10 1/2"
H 5 1/4"
gal. 1 1/3

599
Ø cm. 29
H cm. 18,5
lt. 8

Ø 11 3/8"
H 7 1/4"
gal. 2

730



mm. 1,2 Spumantiera 12 bottiglie champagne
Giant champagne bucket for 12 bottles
Seau à champagne géante pour 12 bouteilles
Champagner Bowl für 12 Flaschen
Cubo de champagne gigante para 12 botellas

cm. 75 x 65
H cm. 19
lt. 15

29 1/2" x 25 5/8"
H 7 1/2"
gal. 3 7/8

438

689

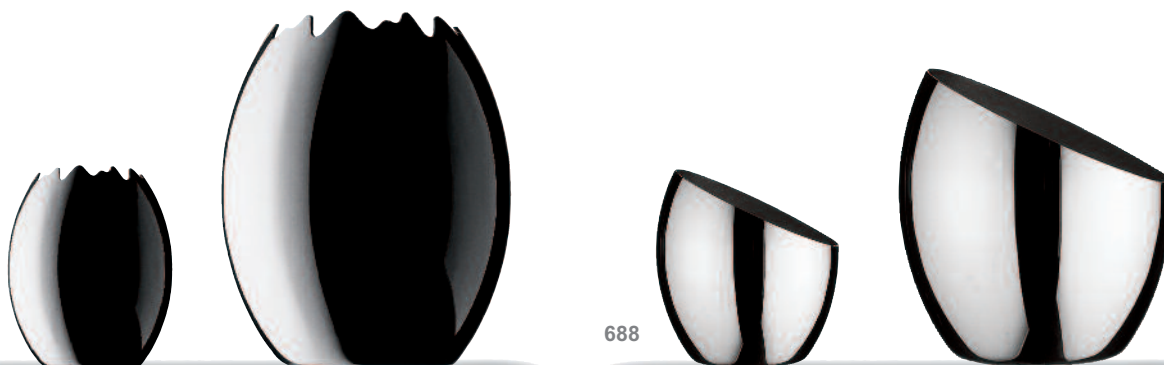

439

mm. 1,2
OVETTO
Secchiello per ghiaccio
Ice-bucket
Seau à glaçons
Eisgefäß
Cubitera hielo

Ø cm. 11
H cm. 13
cl. 100

Ø 4 3/8"
H 5 1/8"
oz. 33 7/8

mm. 1,2
OVO
Secchiello per spumante
Sparkling wine cooler
Seau à champagne
Wein- und Sektkühler
Cubo para champany

Ø cm. 19
H cm. 22
lt. 4,5

Ø 7 1/2"
H 8 5/8"
gal. 1 1/4

688

mm. 1,2
Secchiello per ghiaccio
Ice-bucket
Seau à glaçons
Eisgefäß
Cubitera hielo

Ø cm. 11
H cm. 12,5
cl. 55

Ø 4 3/8"
H 4 7/8"
oz. 18 5/8

mm. 1,2
Secchiello per spumante
Sparkling wine cooler
Seau à champagne
Wein- und Sektkühler
Cubo para champany

Ø cm. 19
H cm. 20
lt. 2,5

Ø 7 1/2"
H 7 3/4"
oz. 84 1/2

598



598
 Ø cm. 29 Ø 11 3/8"
 H cm. 18,5 H 7 1/4"
 lt. 8 gal. 2

mm. 1,2 Cestini
 Baskets
 Corbeilles
 Früchtekorben
 Cestas

607



607
 Ø cm. 27 Ø 10 1/2"
 H cm. 13,5 H 5 1/4"
 lt. 5 gal. 1 1/3



597
 Ø cm. 16,8 Ø 6 5/8"
 H cm. 11 H 4 3/8"
 cl. 150 oz. 50 3/4

597

666C

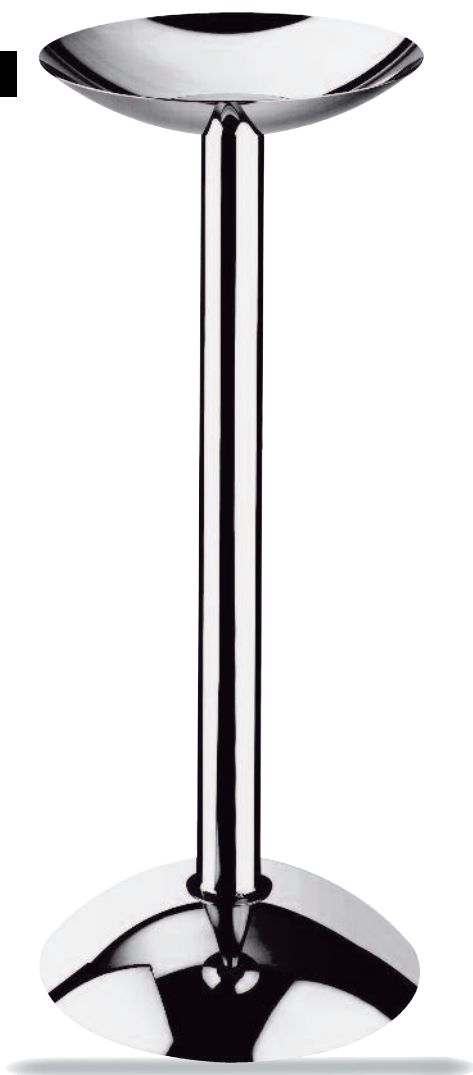

mm. 1,2 UNO
 Colonna portasecchiello spumante
 Wine cooler stand
 Pied pour seu à champagne
 Weinkühlerständer
 Columna porta cubo champany

H cm. 65 H 25 5/8"

912



909

mm. 1,2
 Secchiello per spumante
 Sparkling wine cooler
 Seau à champagne
 Wein- und Sektkühler
 Cubo para champany

cm. 39 x 36
 H cm. 17,5
 lt. 6
 15 3/8" x 14 1/4"
 H 7"
 gal. 1 3/5

mm. 1,2
 Secchiello per ghiaccio
 Ice-bucket
 Seau à glaçons
 Eisgefäß
 Cubitera hielo

cm. 22 x 20
 H cm. 11,5
 lt. 1,2
 H 4 5/8"
 8 3/4" x 7 7/8"
 oz. 40 1/2

910



899

mm. 1,2
 Secchiello per spumante
 Sparkling wine cooler
 Seau à champagne
 Wein- und Sektkühler
 Cubo para champany

cm. 39 x 36
 H cm. 17,5
 lt. 7
 15 3/8" x 14 1/4"
 H 7"
 gal. 1 4/5

mm. 1,2
 Secchiello per ghiaccio
 Ice-bucket
 Seau à glaçons
 Eisgefäß
 Cubitera hielo

cm. 22 x 20
 H cm. 11,5
 lt. 1,6
 8 3/8" x 7 7/8"
 H 4 5/8"
 oz. 54

570



mm. 1,2
Cremiera
Cream jug
Crémier
Sahnegießer/Milchkännchen
Jarrita lechera

Ø cm. 6 Ø 2 3/8"
H cm. 8,8 H 3 1/2"
cl. 16 oz 5 3/8

571



mm. 1,2
Zuccheriera
Sugar bowl
Sucriere
Zuckerdose
Azucarero

Ø cm. 9,5 Ø 3 3/4"
H cm. 6,8 H 2 3/4"
cl. 20 oz 6 3/4

514

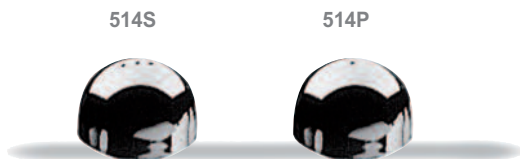

mm. 0,8
GIOTTO
Spargisale e Spargipepe
Salt and pepper cellar
Salière et poivrère
Salz und Pepper-streuer
Salero y pimentero

Ø cm. 3 Ø 1 1/6"
H cm. 3 H 1 1/6"
cl. 5 oz. 1 2/3

999C

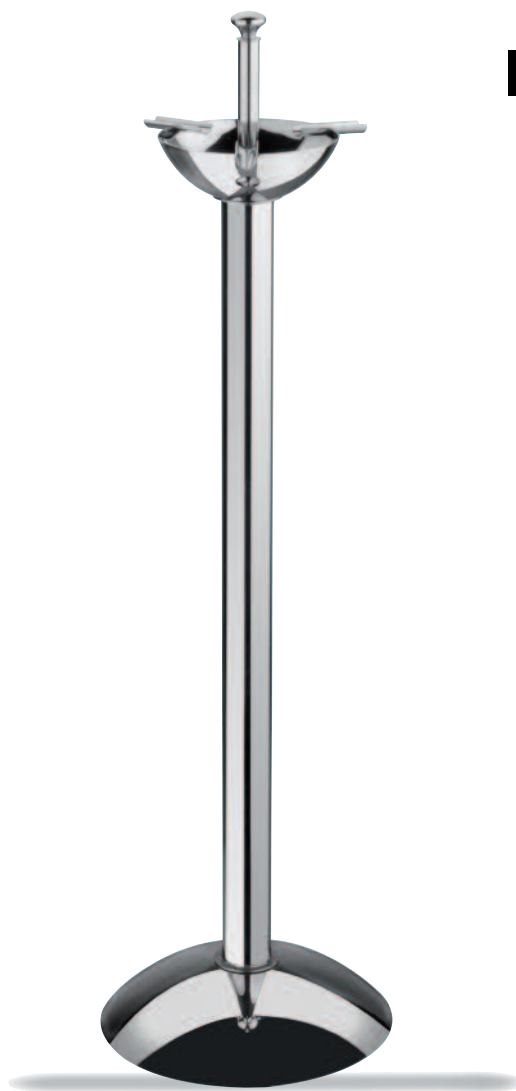

mm. 1,2
Posacenere a colonna
Ashtray column
Borne étouffoir
Ascherständer
Cenicero à columna

H cm 91,5 H 36"

719



mm. 1,2
Bicchiere termico
Insulated shot glass
Shot-verre thermique
Warmhalter Shot Glass
Vaso térmico por chupito

Ø cm. 5 Est. Ø 2" Out.
Ø cm. 4 Int. Ø 1 3/5" Ins.
H cm. 6,3 H 2 1/2"
cl. 6 oz. 2

26202



mm. 1,2 Centrotavola/Fruttieria ovale 2p cm. 46 x 31 18¹/₈" x 12¹/₄"
Elevated centerpiece/Fruit-bowl cm. 37 x 25 14¹/₂" x 9⁷/₈"
Centre de table/Compotier H cm. 28 H 11¹/₈"
Tafelaufsatz/Obstschale lt. 6,5 gal. 1⁵/₇
Centro de mesa/Fruterio

242



mm. 1,2 Centrotavola/Fruttieria tonda Ø cm. 32 Ø 12⁵/₈"
Elevated centerpiece/Fruit-bowl H cm. 19 H 7¹/₂"
Centre de table/Compotier lt. 3,0 oz. 101²/₅
Tafelaufsatz/Obstschale
Centro de mesa/Fruterio

26203



mm. 1,2 Centrotavola/Fruttieria ovale 3p cm. 46 x 31 18¹/₈" x 12¹/₄"
Elevated centerpiece/Fruit-bowl cm. 37 x 25 14¹/₂" x 9⁷/₈"
Centre de table/Compotier 3et. Ø cm. 12 Ø 4³/₄"
Tafelaufsatz/Obstschale 3-Stu. H cm. 37 H 14¹/₂"
Centro de mesa/Fruterio 3pisos lt. 6,7 gal. 1³/₄

24202



mm. 1,2 Centrotavola/Fruttieria tonda 2 piani Ø cm. 32 Ø 12⁵/₈"
Elevated centerpiece/Fruit-bowl 2t Ø cm. 22 Ø 8⁵/₈"
Centre de table/Compotier 2 et. H cm. 29,5 H 11³/₅"
Tafelaufsatz/Obstschale 2-Stufig lt. 4,3 gal. 1¹/₈
Centro de mesa/Fruterio 2 pisos

26204



mm. 1,2 Centrotavola/Fruttieria ovale 4p cm. 55 x 24 21⁵/₈" x 9¹/₂"
Elevated centerpiece/Fruit-bowl cm. 46 x 31 18¹/₈" x 12¹/₄"
Centre de table/Compotier 4et. cm. 37 x 25 14¹/₂" x 9⁷/₈"
Tafelaufsatz/Obstschale 4-Stu. Ø cm. 12 Ø 4³/₄"
Centro de mesa/Fruterio 4pisos H cm. 49 H 19¹/₃"
lt. 7,2 gal. 2

871



mm. 1,2 Cestino portafrutta cm. 24 x 11 9¹/₂" x 4¹/₃"
Fruit basket
Panier à fruits
Obstschale
Cesto porta frutas

Plateau Royal





252



mm. 1,2 Centrotavola/Fruttiaria
Elevated centerpiece/Fruit-bowl
Centre de table/Compotier
Tafelaufsatz/Obstschale
Centro de mesa/Fruterio
cm.38 x 25 15" x 9 7/8"
H cm. 18 H 7 1/8"
cl. 300 oz. 101 1/2

252G



mm. 1,2 Alzata per pesce crudo
Elevated rect.seafood presentation
Serveur à poisson crude
Etagere für marinierten Fisch
Porta pescado
cm.38 x 25 15" x 9 7/8"
H cm. 18 H 7 1/8"
cl. 300 oz. 101 1/2

562V



Rettangolare fondo con vassoio
Rectangular cooling bowl for buffet with insert
Bol rectangulaire à rafraichir avec insert
Kühlschale, rechteckig mit Einsatzteile
Bandeja refrescante rectangular con inserto
cm. 38 x 25
cl. 300
15" x 9 7/8"
oz. 101 1/2

562G



Rettangolare fondo con griglia
Elevated rect.seafood presentation with grill
Bol rectangulaire à rafraichir avec grill
Kühlschale, rechteckig mit Einsatzsieb
Bandeja refrescante rectangular con rejilla
cm. 38 x 25
cl. 300
15" x 9 7/8"
oz. 101 1/2

56422V



Quadro fondo con vassoio
Square cooling bowl for buffet with insert
Bol carré à rafraichir avec insert
Kühlschale, quadr. mit Einsatzteile
Bandeja refrescante cuadrada con inserto
cm. 22x22
cl. 150
8 5/8" x 8 5/8"
oz. 50 3/4

56422G



Quadro fondo con griglia
Square individual seafood presentation with grill
Bol carré à rafraichir avec grill
Kühlschale, quadr. mit Einsatzsieb
Bandeja refrescante cuadrada con rejilla
cm. 22x22
cl. 150
8 5/8" x 8 5/8"
oz. 50 3/4

262G



mm. 1,2 Alzata per pesce crudo
Elevated oval seafood
presentation with grill
Serveur à poisson crude
Etagere für marinierten Fisch
Porta pescado

cm. 46 x 31 18 1/8" x 12 1/4"
H cm. 18 H 7 1/8"
cl. 400 gal. 1

262



mm. 1,2 Centrotavola/Fruttiara
Elevated centerpiece/Fruit-bowl
Centre de table/Compotier
Tafelaufsatz/Obstschale
Centro de mesa/Fruterio

cm. 46 x 31 18 1/8" x 12 1/4"
H cm. 18 H 7 1/8"
cl. 400 gal. 1

558G



Ovale fondo con griglia
Oval seafood presentation with grill
Bol oval à rafraichir avec grill
Kühlschale, oval mit Einsatzsieb
Bandeja refrescante oval con rejilla

cm. 46 x 31
cl. 400
18 1/8" x 12 1/4"
gal. 1

558V



Ovale fondo con vassoio
Oval cooling bowl for buffet with insert
Bol oval à rafraichir avec insert
Kühlschale, oval mit Einsatzteile
Bandeja refrescante oval con inserto

cm. 46 x 31
cl. 400
18 1/8" x 12 1/4"
gal. 1

56022G



Tondo fondo con griglia
Round individual seafood presentation with grill
Bol ronde à rafraichir avec grill
Kühlschale, rund mit Einsatzsieb
Bandeja refrescante redonda con rejilla

Ø cm. 22
cl. 150
Ø cm. 8 5/8"
oz. 50 3/4

56022V



Tondo fondo con vassoio
Round cooling bowl for buffet with insert
Bol ronde à rafraichir avec insert
Kühlschale, rund mit Einsatzteile
Bandeja refrescante redonda con inserto

Ø cm. 22
cl. 150
Ø cm. 8 5/8"
oz. 50 3/4

242G



mm. 1,2	Alzata tonda per pesce crudo	Ø cm.32	Ø 12 5/8"
	Elevated round thirty-two stand	H cm. 19	H 7 1/2"
	Serviteur ronde à poisson crude	lt. 3,0	oz. 101 2/5
	Etagere, rund, für marinierte		
	Fisch	Ø cm.22	Ø 8 5/8"
	Porta pescado redondo	H cm. 18	H 7 1/8"
		lt. 1,31	oz. 44 1/3

26202G



mm. 1,2	Alzata ovale per pesce crudo 2p	cm. 46 x 31	18 1/8" x 12 1/4"
	Oval two tier seafood stand	cm. 37 x 25	14 1/2" x 9 7/8"
	Serviteur ovale à poisson crude	H cm. 28	H 11 1/8"
	Etagere, oval, für marinierten	lt. 6,5	gal. 1 5/7
	Fisch		
	Porta pescado oval 2 pisos		

24202G



mm. 1,2	Alzata tonda per pesce crudo 2p	Ø cm. 32	Ø 12 5/8"
	Round two tier seafood stand	Ø cm. 22	Ø 8 5/8"
	Servit.ronde à poisson crude 2 et.	H cm. 29,5	H 11 3/5"
	Etagere, rund, für marinierte Fisch	lt. 4,3	gal. 1 1/8
	2-Stufig		
	Porta pescado redondo 2 pisos		

26203G



mm. 1,2	Alzata ovale per pesce crudo 3p	cm. 46 x 31	18 1/8" x 12 1/4"
	Oval three tier seafood stand	cm. 37 x 25	14 1/2" x 9 7/8"
	Serviteur ovale à poisson crude	Ø cm. 12	Ø 4 3/4"
	Etagere, oval, für marinierten	H cm. 37	H 14 1/2"
	Fisch 3 -Stufig	lt. 6,7	gal. 1 3/4
	Porta pescado oval 3 pisos		

485



APRIL	cm. 15	5 7/8"
Coltello per ostriche		
Oyster knife		
Couteau à huîtres		
Austernöffner		
Cuchillo de ostras		

26204G



mm. 1,2	Alzata ovale per pesce crudo 4p	cm. 55 x 24	21 5/8" x 9 1/2"
	Oval four tier seafood stand	cm. 46 x 31	18 1/8" x 12 1/4"
	Serviteur ovale à poisson crude	cm. 37 x 25	14 1/2" x 9 7/8"
	Etagere, oval, für marinierten	Ø cm. 12	Ø 4 3/4"
	Fisch 4-Stufig	H cm. 49	H 19 1/3"
	Porta pescado oval 4 pisos	lt. 7,2	gal. 2

235G



mm. 1,2 Vassoio rotondo per pesce crudo Ø cm.38
 Round seafood tray H cm. 9
 Plateau rond à poisson crude lt. 3,0
 Tablett, rund für marinierten Fisch
 Porta pescado redondo

Ø 15"
 H 3 1/2"
 oz. 101 2/5

235

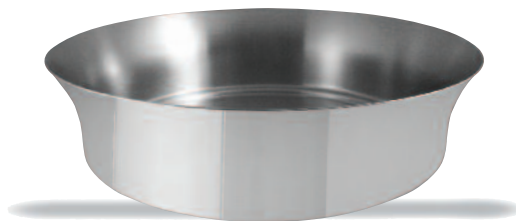

mm. 1,2 Centrotavola/Fruittiera Ø cm.38
 Centerpiece/Fruit-bowl H cm. 9
 Centre de table/Compotier H 3 1/2"
 Tafelaufsatz/Obstschale lt. 3,0
 Centro de mesa/Fruterо oz. 101 2/5





Finger Food

10001129



mm. 2,5 Quarta posata

Lungh. cm. 22,2 Length 8 3/4"

25506



mm. 1,2 Micro presentoir

H cm. 13 H 5 1/9"
 Ø cm. 6 (x5) Ø 2 1/3" (x5)
 Ø cm. 8 Ø 3 1/7"

25508



mm. 1,2 Mini presentoir

H cm. 17 H 6 5/8"
 Ø cm. 8 (x5) Ø 3 1/7" (x5)
 Ø cm. 11 Ø 4 3/8"



10341146

NEW

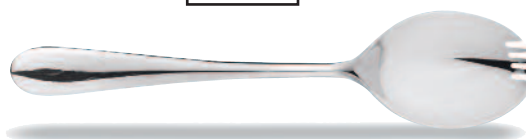

mm. 3,0 Cucchiaino multifunzione
 Multifunctional spoon
 Cuillère multifonctionnelle
 Multifunktionaler Löffel
 Cuchara multifuncional

cm. 17,6 6 8/9"

537

53706

53712



mm. 1,2 Mini vassoio quadro 6/12 comp. cm. 12 x 12 4 3/4" x 4 3/4"
6/12 comp. Mini square tray cm. 15 x 15 5 7/8" x 5 7/8"
Mini plateau carré 6/12 pos.
Mini Tablett, eckig., 6/12 Eins.
Mini bandeja cuadrada 6/12 p.

549



mm. 1,2 Vassoio rettangolare 14 comp. cm 45 x 28 17 3/4" x 11 1/8"
Rectangular tray 14 comp.
Plateau rectangulaire 14 plac.
Tablett, rechteckig 14 Eins.
Bandeja rectangular 14 posic.

520

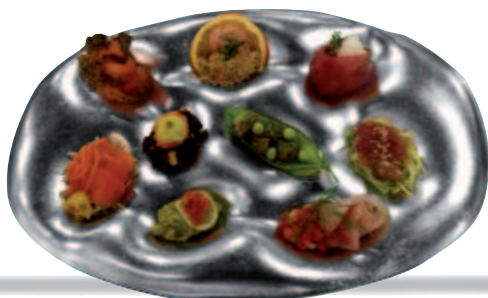

mm. 1,2 Vassoio ovale 9 compart. cm. 35 x 25,5 13 3/4" x 10"
Oval tray 9 compartments
Plateau oval 9 comp.
Tablett, oval, 9 Einsätze
Bandeja oval 9 posiciones

791E

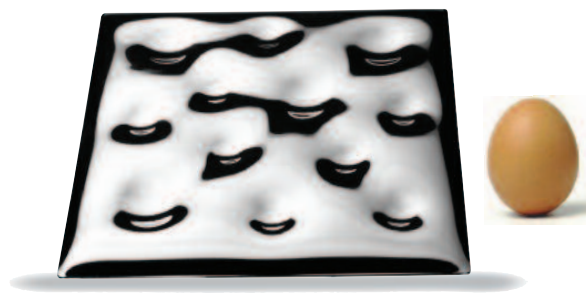

mm. 1,2 Vassoio da buffet per uova cm. 30 x 30 11 7/8" x 11 7/8"
Egg tray for buffet
Plateau à oeufs pour buffet
Egg-tablett für Buffet
Bandeja porta huevos por buffet

52922



mm. 1,2 Vassoio quadro 8 compart. cm. 22 x 22 8 5/8" x 8 5/8"
8 comp. Square tray
Plateau carré 8 pos.
Tablett, eckig., 8 Eins.
Bandeja cuadrada 8 posic.

526

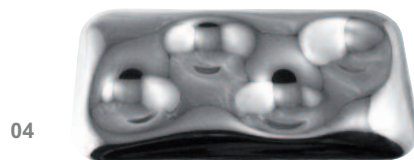

mm. 1,2 Vassoio rettangolare a 3 o 4 comp. cm. 23 x 13 9" x 5 1/8"
Rectangular tray 3 or 4 comp.
Plateau rectangulaire 3 ou 4 plac.
Tablett, rechteckig 3 oder 4 Eins.
Bandeja rectangular 3 o 4 posic.

FINGER FOOD

791AC



mm. 1,2 Insetto per finger food
Finger food insert
Insért pour finger food
Finger food Einsatz
Insetto por finger food

cm. 30 x 30 117/8" x 117/8"

791



Vassoio/Sottopiatto
Square Tray/Charger
Plateau/Assiette de bienvenue
Tablett/Platzteller,
Bandeja/Bajo plato

cm. 32 x 32 123/4" x 123/4"

700



mm. 1,2 Portapatatine fritte
French fry holder for table
Porte pommes frites pour table
Kartoffenbehälter für Tisch
Porta patatas fritas por mesa

H cm 10 H 4"
cl. 35 oz. 11 7/8

902



mm. 1,2 Portapatatine fritte
French fry holder for table
Porte pommes frites pour table
Kartoffenbehälter für Tisch
Porta patatas fritas por mesa

H cm 8 H 3 1/4"
Ø cm 7 Ø 2 3/4"

260



mm. 1,2 Portapatatine fritte
French fry holder for table
Porte pommes frites pour table
Kartoffenbehälter für Tisch
Porta patatas fritas por mesa

Ø cm 10 H 3 3/4"
H cm 9,5 Ø 3 7/8"

289



mm. 1,2 Portapatatine fritte
French fry holder for table
Porte pommes frites pour table
Kartoffenbehälter für Tisch
Porta patatas fritas por mesa

H cm. 10 H 3 7/8"
Ø cm. 6 Ø 2"

53012



mm. 1,2 23053012
 Mini vaporiera
 Mini steamer
 Mini vaporisateur
 Mini Verdampfer
 Mini vaporizador

Ø cm. 12 Ø 4 3/4"
 H cm. 14,5 H 5 3/4"
 cl. 24 oz. 8

53022



mm. 1,2 23053022
 Vaporiera
 Steamer
 Vaporisateur
 Verdampfer
 Vaporizador

Ø cm. 32 Ø 12 5/8"
 H cm. 26 H 10 1/4"
 lt. 3,0 oz. 101 2/5



FINGER FOOD

557T



557

557T

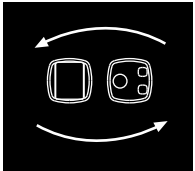

Combinabile con
Ciotole in vetro
Ciotole in policarbonato
Ciotole in porcellana
Coperchio in acciaio
inossidabile 18/10

Combinable with
Glass bowls
Polycarbonate bowls
China bowls
18/10 st.st. lid

Combinable avec
Bols en verre
Bols en Polycarbonat
Bols en porcelaine
Couvercle en acier
inoxydable18/10

Kombinierbar mit
Glasschalen
Polycarbonatschalen
Porzellanschalen
18/10-Deckel

Combinable con
Cuencos en cristal
Cuencos en policarbonato
Cuencos en China
Tapa en acero inoxidable
18/10

561M



56138

561M

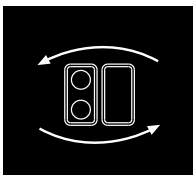

Combinabile con
Ciotole in vetro
Ciotole in policarbonato
Vassoio in acciaio
inossidabile 18/10

Combinable with
Glass bowls
Polycarbonate bowls
Tray in 18/10
stainless steel

Combinable avec
Bols en verre
Bols en Polycarbonat
Plateau en acier
inoxydable18/10

Kombinierbar mit
Glasschalen
Polycarbonatschalen
Edelstahlschalen

Combinable con
Cuencos en cristal
Cuencos en policarbonato
Cuencos en acero
inoxidable 18/10

561T



561T

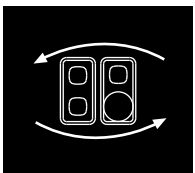

Combinabile con
Ciotole in vetro
Ciotole in policarbonato
Ciotole in porcellana
Coperchio in acciaio
inossidabile 18/10
Ampolle in vetro
Piatti in vetro

Combinable with
Glass bowls
Polycarbonate bowls
China bowls
18/10 st.st. lid
Glass bottles
Glass trays

Combinable avec
Bols en verre
Bols en Polycarbonat
Bols en porcelaine
Couvercle en acier
inoxydable18/10
Bouteilles en verre
Plateaus en verre

Kombinierbar mit
Glasschalen
Polycarbonatschalen
Porzellanschalen
18/10-Deckel
Karaffen
Glasplatten

Combinable con
Cuencos en cristal
Cuencos en policarbonato
Cuencos en China
Tapa en acero inoxidable
18/10
Botellas en vidrio
Platos en vidrio



56122

561M

561T

FINGER FOOD

563T15

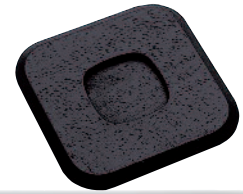

56315

563T15

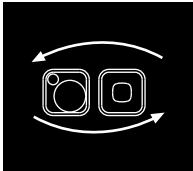

Combinabile con
Ciotole in vetro
Ciotole in policarbonato
Ciotole in porcellana
Coperchio in acciaio
inossidabile 18/10
Ampolle in vetro

Combinable with
Glass bowls
Polycarbonate bowls
China bowls
18/10 st.st. lid
Glass bottles

Combinable avec
Bols en verre
Bols en Polycarbonat
Bols en porcelaine
Couvercle en acier
inoxydable 18/10
Bouteilles en verre

Kombinierbar mit
Glasschalen
Polycarbonatschalen
Porzellanschalen
18/10-Deckel
Karaffen

Combinable con
Cuencos en cristal
Cuencos en policarbonato
Cuencos en China
Tapa en acero inoxidable
18/10
Botellas en vidrio

563T22



56322

563T22

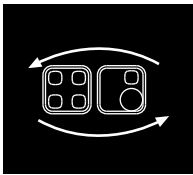

Combinabile con
Ciotole in vetro
Ciotole in policarbonato
Ciotole in porcellana
Coperchio in acciaio
inossidabile 18/10
Ampolle in vetro

Combinable with
Glass bowls
Polycarbonate bowls
China bowls
18/10 st.st. lid
Glass bottles

Combinable avec
Bols en verre
Bols en Polycarbonat
Bols en porcelaine
Couvercle en acier
inoxydable 18/10
Bouteilles en verre

Kombinierbar mit
Glasschalen
Polycarbonatschalen
Porzellanschalen
18/10-Deckel
Karaffen

Combinable con
Cuencos en cristal
Cuencos en policarbonato
Cuencos en acero
inoxidable 18/10
Botellas en vidrio

563T22



567

563T22

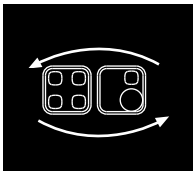

Combinabile con
Ciotole in vetro
Ciotole in policarbonato
Ciotole in porcellana
Coperchio in acciaio
inossidabile 18/10
Ampolle in vetro

Combinable with
Glass bowls
Polycarbonate bowls
China bowls
18/10 st.st. lid
Glass bottles

Combinable avec
Bols en verre
Bols en Polycarbonat
Bols en porcelaine
Couvercle en acier
inoxydable 18/10
Bouteilles en verre

Kombinierbar mit
Glasschalen
Polycarbonatschalen
Porzellanschalen
18/10-Deckel
Karaffen

Combinable con
Cuencos en cristal
Cuencos en policarbonato
Cuencos en acero
inoxidable 18/10
Botellas en vidrio



578

577

584

587

585

572

572A

352

A close-up photograph of a silver heart-shaped mold being filled with red wine. The mold is placed on a white, textured napkin. A stream of red wine is being poured from a white ceramic pitcher into the mold. The scene is set on a gold-colored tray with a perforated surface. The overall composition is elegant and artistic.

748
Porta sorpresa

Specialist



260 Vaso

703AC Piattino



744
Cestino

750
Microforchetta



753
Alzata

920
Appoggia posate



919
Cestino Palace



Quarta Posata

754
Vassoio

748



mm. 1,2 Porta sorpresa
Surprises set
Porte-surprises
Universalträger
Puerta sorpresas

703AC



mm. 1,2 Piattino
Tray
Plat
Tablett
Bandeja
Ø cm. 10 Ø 3 7/8"

260



mm. 1,2 Vaso
Jar
Vase
Vase
Florero
H cm. 9,5 H 3 3/4"
Ø cm. 10 Ø 3 7/8"

744



mm. 1,2 Cestino
Basket
Corbeille
Früchtekorb
Cesta
H cm. 11,5 H 4 1/2"
Ø cm. 10 Ø 3 7/8"

750



mm. 1,5 Micro forchetta
Micro fork
Micro fourchette
Mikrogabel
Micro tenedor

743



mm. 1,2 Cestino
Basket
Corbeille
Früchtekorb
Cesta
H cm. 11,5 H 4 1/2"
Ø cm. 10 Ø 3 7/8"

753



mm. 1,2
Alzata
Holder
Serviteur
Etagere
Frutero

H cm. 16 H 6 1/3"
Ø cm. 12 Ø 4 3/4"

920



mm. 1,2 Appoggia posate cm. 10 x 8 4" x 3 1/7"
Knife rest
Soutier p/couverts
Besteck Ablage
Apoyo p/cubiertos

919



mm. 1,2 Cestino con maniglie
Basket with handles
Corbeille avec poignée
Schale mit Griffen
Frutero con asas

H cm. 11,5 H 4 1/2"
Ø cm. 12 Ø 4 3/4"
cl. 26 OZ 8 4/5

754



mm. 1,2 Vassoio con fori Ø cm. 28,5 Ø 11 1/5"
Tray with holes
Plateau avec trous
Tablett mit Löchern
Bandeja con agujeros

523



mm. 1,2 Mini cestello con coperchio
Mini basket with lid
Mini corbeille avec couvercle
Mini Schale mit Deckel
Mini cuenco con tapa

H cm. 10 H 4"
Ø cm. 9,4 Ø 3 5/7"

501

500

739



mm. 1,2 Cestino con coperchio
Basket with lid
Corbeille avec couvercle
Schale mit Deckel
Cuenco con tapa

H cm. 16 H 6 1/3"
Ø cm. 12 Ø 4 3/4"
cl. 26 OZ 8 4/5

718



mm. 1,2 Tumbler

H cm. 8,2 H 3 1/4"
 Ø cm. 7,2 Ø 3 4/5"
 cl. 30 oz. 10 1/7

916



mm. 1,2 Poggia pane
 Tray for bread
 Plateau pour pan
 Brot Tablett
 Bandeja por pan

Ø cm. 19,7 Ø 7 3/4"

918

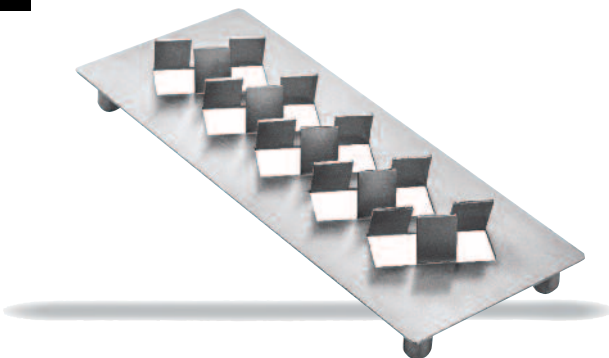

mm. 1,2 Porta crackers
 Crackers holder
 Porte craquelins
 Cracker Schale
 Puerta galletas saladas

cm. 20 x 8 7 7/8" x 3 1/7"

872



mm. 1,2 Portagrissini
 Bread sticks tray
 Porte gressin
 Grissini Schale
 Cuenco porta bastoncillos
 de pan

cm. 24 x 6 H 9 3/8" x 2 2/3"

717



mm. 1,2 Saucière cl. 4 oz. 4

738



mm. 1,2 GIOTTO
 Coppetta con vassoio
 Cup and tray
 Coupe avec plateau
 Schale mit Tablett
 Cuenco con bandeja

Ø cm. 9
 Ø 3 1/2"

Coppetta amouse bouche
 Appetizer bowl
 Bol multi-usages
 Fingerfood-/Vorspeisen-/Butter-
 Gefäß
 Cuenco para finger food/amouse
 bouche

cm. 13 x 7
 cl. 4
 5 1/9" x 2 3/4"
 oz. 4

740



745
Vassoio
petit four



742
Piattino pasticceria



747
Porta bon bon



Vassoio petit four
745



990
Coppetta con vassoio



745
Vassoio petit four



742
Piattino
pasticceria



746
Vassoietto
petit four



914



mm. 1,2 PALACE
Vassoietto
Tray
Plateau
Tablett
Bandeja

cm. 13 x 7 5 1/9" x 2 3/4"

737



mm. 1,2 GIOTTO
Vassoietto
Tray
Plateau
Tablett
Bandeja

cm. 13 x 7 5 1/9" x 2 3/4"

745



mm. 1,2 Vassoio petit four
Petit-fours tray
Plateau petit-fours
Petit-Fours Tablett
Porta dulces

cm. 26 10 1/4"

746



mm. 1,2 Vassoietto petit four
Petit-fours tray
Plateau petit-fours
Petit-Fours Tablett
Porta dulces

cm. 17,5 6 7/8"

742



Piattino per pasticceria H cm. 17,5 H 6 7/8"
Petit-fours stand Ø cm. 14 Ø 5 1/2"
Porte-petit fours
Mokkaétagère
Porta dulces
mm. 1,2

990



PALACE
Coppetta con vassoio
Cup and tray
Coupe avec plateau
Schale mit Tablett
Cuenco con bandeja
mm. 1,2

H cm. 11,5 H 4 1/2"
Ø cm. 10 Ø 3 7/8"

747



Cestino
Basket
Corbeille
Früchtekorb
Cesta
mm. 1,2

H cm. 11,5 H 4 1/2"
Ø cm. 10 Ø 3 7/8"

990



738



746
Vassoietto
petit four

914
Vassoietto
Palace



737
Vassoietto
Giotto





Fashion

403

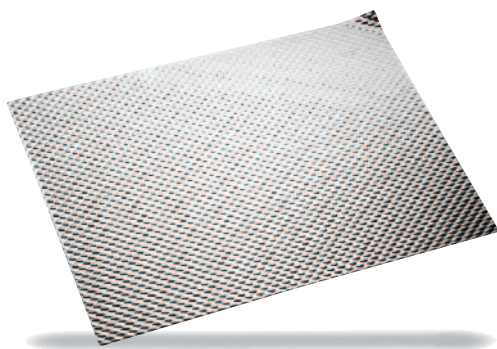

mm. 1,0 Tovaglietta americana cm. 41 x 31 16 2/5" x 12 1/4"
Place mat
Set de table americain
Tischset
Individual en acero

420

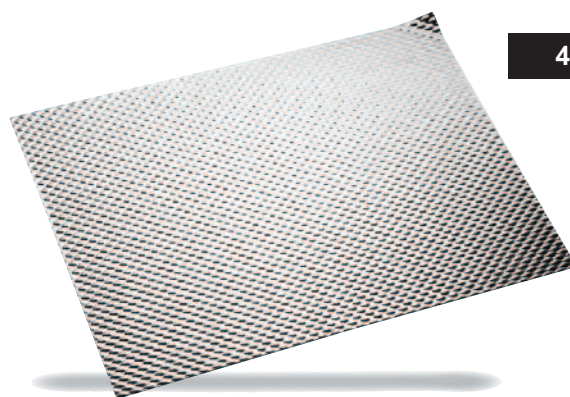

mm. 1,0 Vassoio gastronorm 1/1 cm. 53 x 32,5 20 3/4" x 12 2/3"
Tray gastronorm 1/1
Plateau gastronorm 1/1
Tablett, gastronorm 1/1
Bandeja gastronorm 1/1

416

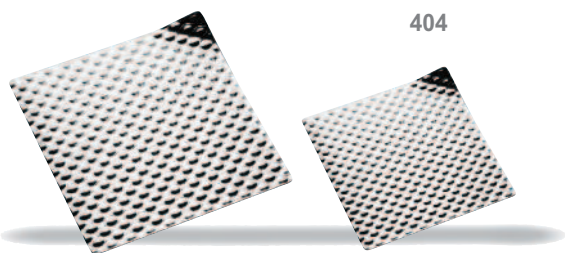

mm. 1,0 Vassoio finger food cm. 20 x 20 7 7/8" x 7 7/8"
Finger food tray
Plateau pour finger food
Finger Food Tablett
Bandeja por finger food

404
Portapane/Sottobottiglia cm. 12,5 x 12,5 5" x 5"
Bread tray/Bottle coaster
Brot Tablett/Flaschenteller
Porte pan/Dessous de
bouteille
Portapan/Posabotella

426

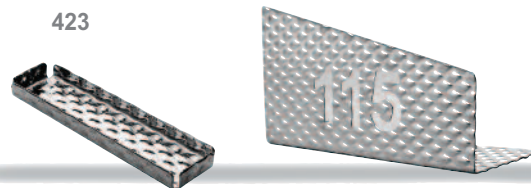

423
mm. 1,0 Portastuzzicadenti cm. 11 x 3 4 1/3" x 1 1/5"
Toothpick container
Porte-cure-dents
Zahnstocherbehälte
Porta-palillos

115
Numero da tavola cm. 15 x 8 6" x 3 1/7"
Table number stand
Numéro de table
Tischnummer-Ständer
Numero de mesa

422

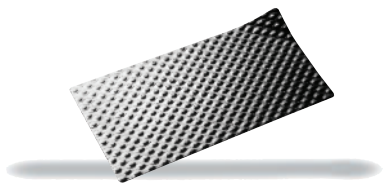

mm. 1,2 Vassoio amouse bouche cm. 20 x 10 7 7/8" x 4"
Amouse bouche tray
Plateau amouse bouche
Amouse bouche Tablett
Bandeja amouse bouche

418

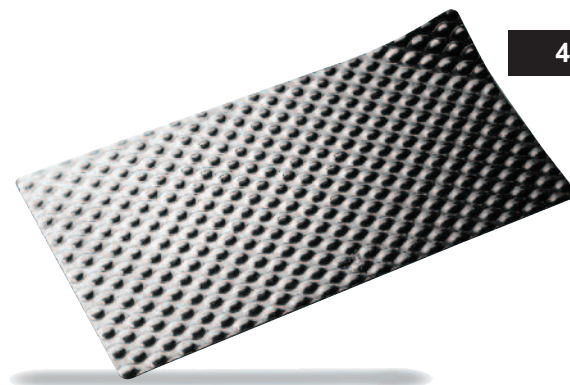

mm. 1,0 Vassoio gastronorm 2/4 cm. 53 x 16,2 20 3/4" x 6 3/8"
Tray gastronorm 2/4
Plateau gastronorm 2/4
Tablett, gastronorm 2/4
Bandeja gastronorm 2/4

417

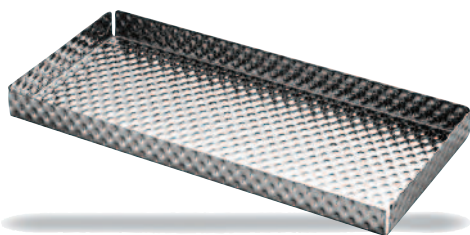

mm. 1,0 Cestino per pane e grissini cm. 26 x 12 10 1/4" x 4 3/4"
 Bread/Bread sticks basket
 Corbeille pour pan et gressin
 Brot- und Grissinikorb
 Cesta por pan y bastoncillos de pan

419

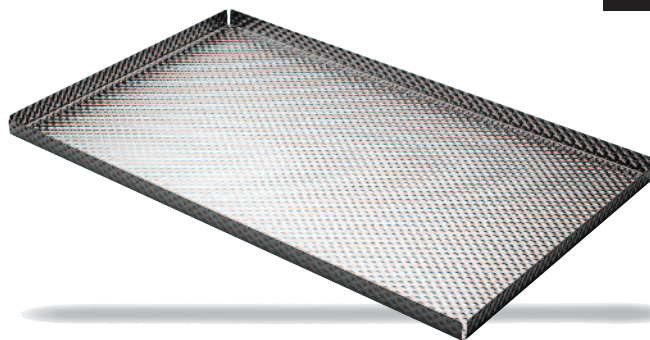

mm. 1,0 Vassoio gastronom c/bordo cm. 53 x 32,5 20 3/4" x 12 2/3"
 Tray gastronom w/edges
 Plateau gastronom a/bords
 Tablett, gastronom m/Kanten
 Bandeja gastronom c/bordes

429

NEW

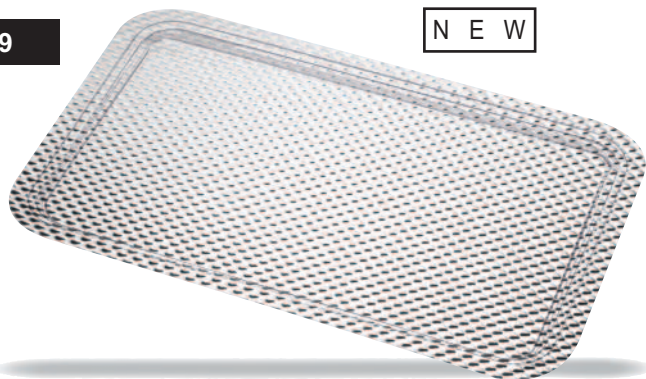

mm. 1,0 Vassoio per carrelli cm. 45 x 31 17 3/4" x 12 1/4"
 Tray for rack trolley cm. 63 x 45 24 11/16" x 17 3/4"
 Plateau pour chariot
 porte-plateau
 Tablett für Rack
 Bandeja para estante

NEW

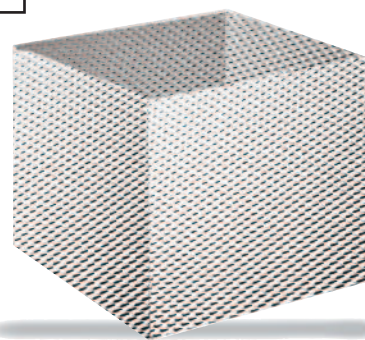

mm. 1,0 Secchiello per spumante H cm. 21 H 8 1/4"
 Sparkling wine cooler cm. 21 x 21 8 1/4" x 8 1/4"
 Seau à champagne lt. 9 gal. 2 1/2
 Wein- und Sektkühler
 Cubo para champany

430

427

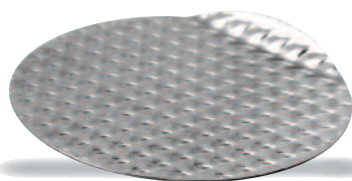

mm. 1,0 Sottobottiglia Ø cm. 10 Ø 4"
 Bottle coaster
 Dessous de bouteille
 Flaschenteller
 Posabotella

428

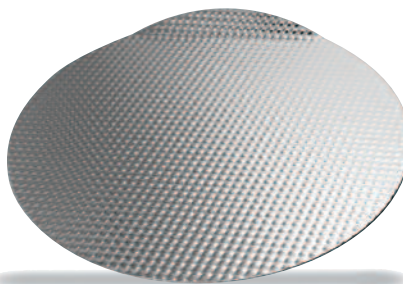

mm. 1,0 Sottopiatto Ø cm. 34 Ø 13 3/8"
 Charger
 Assiette de bienvenue
 Platzteller
 Bajo plato





Buffet 4.0

212A



mm. 1,2 Centrotavola/Fruttiara cm. 38 x 32 15" x 9 7/8"
Elevated centerpiece/Fruit-bowl H cm. 20 H 7 3/4"
Centre de table/Compotier
Tafelaufsatz/Obstschale
Centro de mesa/Fruterero

222A



mm. 1,2 Centrotavola/Fruttiara cm. 46 x 31 18 1/4" x 12 1/4"
Elevated centerpiece/Fruit-bowl H cm. 20 H 7 3/4"
Centre de table/Compotier
Tafelaufsatz/Obstschale
Centro de mesa/Fruterero

212



mm. 1,2 Centrotavola/Fruttiara cm. 38 x 32 15" x 9 7/8"
Elevated centerpiece/Fruit-bowl H cm. 13,2 H 5 1/5"
Centre de table/Compotier
Tafelaufsatz/Obstschale
Centro de mesa/Fruterero

222



mm. 1,2 Centrotavola/Fruttiara cm. 46 x 31 18 1/4" x 12 1/4"
Elevated centerpiece/Fruit-bowl H cm. 13,2 H 5 1/5"
Centre de table/Compotier
Tafelaufsatz/Obstschale
Centro de mesa/Fruterero

561



mm. 1,2 Rettangolare piano cm. 23 x 13 9" x 5 1/8"
Rectangular tray cm. 38 x 25 15" x 9 7/8"
Plateau rectangulaire
Tablett, rechteckig
Bandeja rectangular

557



mm. 1,2 Ovale piano cm. 37 x 25 14 1/2" x 9 7/8"
Oval tray cm. 46 x 31 18 1/4" x 12 1/4"
Plateau, oval
Tablett, oval
Bandeja oval

Colori disponibili
Available colors
Couleurs disponibles
Verfügbare Farben
Colores disponibles



O Onice
Onyx
Onyx
Onyx
Onice



N Nero
Black
Noir
Schwarz
Negro



W Trasparente
Transparent
Glace
Transparent
Vidrio



P Porcellana
White
Porcelain
Weiss
Porcelana



Cereali

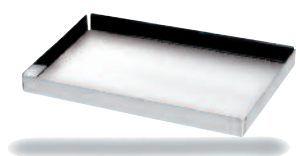

265
Vassoio per pasticceria
Patisserie tray
Plateau pour patisserie
Patisserie Tablett
Bandeja para pasteleria

cm. 24,5 x 17
cm. 30 x 21
cm. 34 x 24

9 5/8" x 6 3/4"
11 3/4" x 8 1/4"
13 3/8" x 9 1/2"

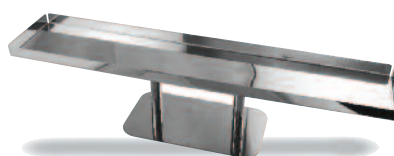

205
Vassoio per pasticceria c/pied.
Patisserie tray with foot
Plateau pour patisserie a/socle
Patisserie Tablett mit Fuss
Bandeja para pasteleria c/pies

cm. 26 x 12
cm. 60 x 12
H cm. 13

10 1/4" x 4 3/4"
23 3/5" x 10 1/5"
H 5 1/9"



206
Vassoio per pasticceria
Patisserie tray
Plateau pour patisserie
Patisserie Tablett
Bandeja para pasteleria

cm. 26 x 12
cm. 60 x 12

10 1/4" x 4 3/4"
23 3/5" x 10 1/5"



270
Portatovaglioli
Napkin holder
Distributeur de serviettes
Serviettenhalter
Portaservilletas

cm. 12,5 x 4,5
H cm. 7

5" x 1 7/8"
H 2 3/4"

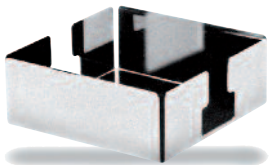

704
 Portatovaglioli
 Napkin holder
 Distributeur de serviettes
 Serviettenhalter
 Portaservilletas

cm. 13 x 13

5 1/9" x 5 1/9"



516
 Portabustine da zucchero
 Sugar packet holder
 Pot à sucre
 Zuckerstangengefäß
 Azucarera

cm. 10 x 7
 H cm. 3

4" x 2 3/4"
 H 1 1/8"



150
 Piatto concavo
 Crescent plate
 Plateau concave
 Konkave Platte
 Plato concavo

Ø cm. 14 Ø 5 1/2"
 Ø cm. 18 Ø 7"
 Ø cm. 20 Ø 7 7/8"
 Ø cm. 22 Ø 8 5/8"
 Ø cm. 24 Ø 9 1/2"
 Ø cm. 26 Ø 10 1/4"
 Ø cm. 28 Ø 11"



744
 Cestino
 Basket
 Corbeille
 Früchtekorb
 Cesta

H cm. 11,5
 Ø cm. 10

H 4 1/2"
 Ø 3 7/8"

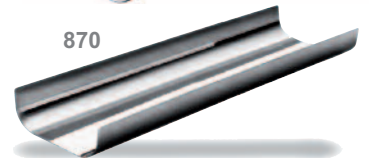
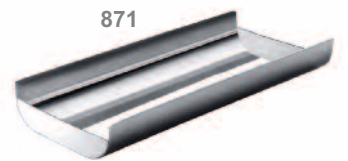

870 - 871
 GIOTTO
 Portapane / Portagrissini
 Bread / Bread sticks holder
 Porte pan / Porte gressin
 Brot und-Grissini -Schale
 Portapan / Porta bastoncillos de pan

870
 cm. 35,5 x 11
 14" x 4 1/3"

871
 cm. 24 x 11
 9 1/2" x 4 1/3"

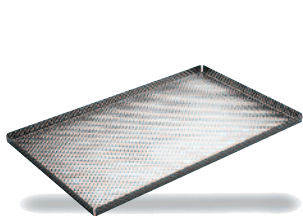

419
FASHION
Vassoio gastronom c/bordo 1/1
Tray gastronom w/edges 1/1
Plateau gastronom a/bords 1/1
Tablett, gastronom m/Kanten 1/1
Bandeja gastronom c/bordes 1/1

cm. 53 x 32,5

20 ³/₄" x 12 ²/₃"
192

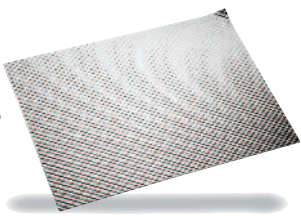

420
FASHION
Vassoio gastronom 1/1
Tray gastronom 1/1
Plateau gastronom 1/1
Tablett, gastronom 1/1
Bandeja gastronom 1/1

cm. 53 x 32,5

20 ³/₄" x 12 ²/₃"

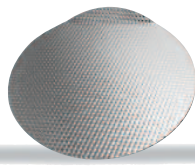

428
FASHION
Sottopiatto
Charger
Assiette de bienvenue
Platzteller
Bajo plato

Ø cm. 34

Ø 13 ³/₈"

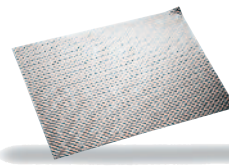

403
FASHION
Tovaglietta americana
Place mat
Set de table americain
Tischset
Individual en acero

cm. 41 x 31

12 ¹/₄" x 16 ²/₅"

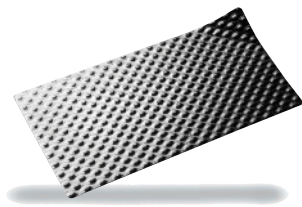

418
FASHION
Vassoio gastronom 2/4
Tray gastronom 2/4
Plateau gastronom 2/4
Tablett, gastronom 2/4
Bandeja gastronom 2/4

cm. 53 x 16,2

20 ³/₄" x 6 ³/₈"

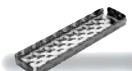
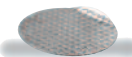
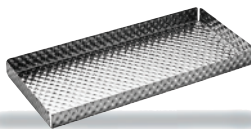
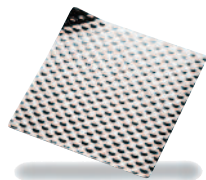
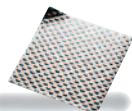
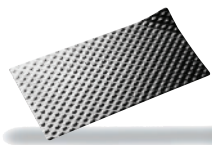

422
FASHION
Vassoio amouse buche
Amouse buche tray
Plateau amouse buche
Amouse buche Tablett
Bandeja amouse buche

cm. 20 x 10

7 7/8" x 4"

404
FASHION
Portapan/Sottobottiglia
Bread tray/Bottle coaster
Porte pan/Dessous de
bouteille
Brot Tablett/Flaschenteller
Portapan/Posabotella

cm. 12,5 x 12,5

5" x 5"

416
FASHION
Vassoio finger food
Finger food tray
Plateau pour finger food
Finger Food Tablett
Bandeja por finger food

cm. 20 x 20

7 7/8" x 7 7/8"

417
FASHION
Cestino per pane e grissini
Bread/Bread sticks basket
Corbeille pour pan et gressin
Brot- und Grissinikorb
Cesta por pan y bastoncillos
de pan

cm. 26 x 12

10 1/4" x 4 3/4"

427
FASHION
Sottobottiglia
Bottle coaster
Dess.de bouteille
Flaschenteller
Posabotella

Ø cm. 10

Ø 4"

423
FASHION
Portastuzzicadenti/Appoggiaposate
Toothpick container/Knife rest
Porte-cure-dents/Soutier p/couverts
Zahnstocherbehälter/Messer bank
Porta-palillos/Apoyo p/cubiertos

cm. 11 x 3

4 1/3" x 1 1/5"



391
H cm. 13
H 5 1/9"



387
H cm. 10
H 4"



382
H cm. 7,5
H 3"



383
H cm. 5,5
H 2 1/6"

Basi
Risers
Stands de buffet
Buffetständer
Soportes de buffet



390
H cm. 6
H 2 1/3"



388
H cm. 7,4
H 2 7/8"



389
H cm. 14
H 5 1/2"



386
H cm. 7,5
H 3"



385
H cm. 3,0
H 1 1/4"



384
H cm. 8,5
H 3 3/8"



Buffet

682



TU0687G

mm. 0,8

Caraffa per bibite
Jug for drinks w/ice container
Carafe avec compartiment glaçons
Saftkrug mit Kühleinsatz
Jarra agua

lt. 2,5 84 1/2 oz.

691



TU0692V

mm. 0,8

Infusiera con contenitore trasparente
Infuser jug
Carafe d'eau avec infuseur
Wasserkrug mit Infuser
Jarra de agua de infusión

lt. 2,5 84 1/2 oz.

68702



TU0687G

mm. 0,8

AURORA
Caraffa per bibite
Jug for drinks w/ice container
Carafe avec compartiment glaçons
Saftkrug mit Kühleinsatz
Jarra agua

lt. 2 67 3/4 oz.

69202



TU0692V

mm. 0,8

AURORA
Infusiera con contenitore trasparente
Infuser jug
Carafe d'eau avec infuseur
Wasserkrug mit Infuser
Jarra de agua de infusión

lt. 2 67 3/4 oz.

BUFFET

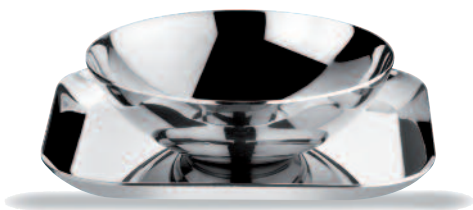
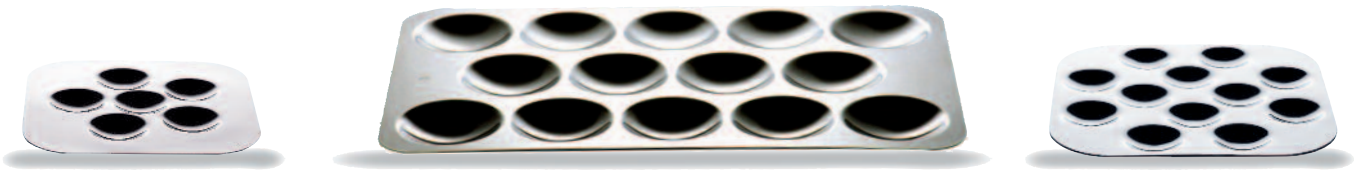



549

537



mm. 1,2 Centrotavola
Tray 14 compartments
Plateau 14 pièces
Tablett 14 Einsätze
Bandeja 14 posiciones

53706



mm. 1,2 Mini vassoi per finger food
Mini trays for finger food
Mini plateau pour finger food
Mini Tablett für finger food
Mini bandejas por finger food

53712



cm. 12 x 12 4 3/4" x 4 3/4"
cm. 15 x 15 5 7/8" x 5 7/8"

cm. 45 x 28 17 3/4" x 11 1/8"

7011

7011E



cl. 9 - oz. 3

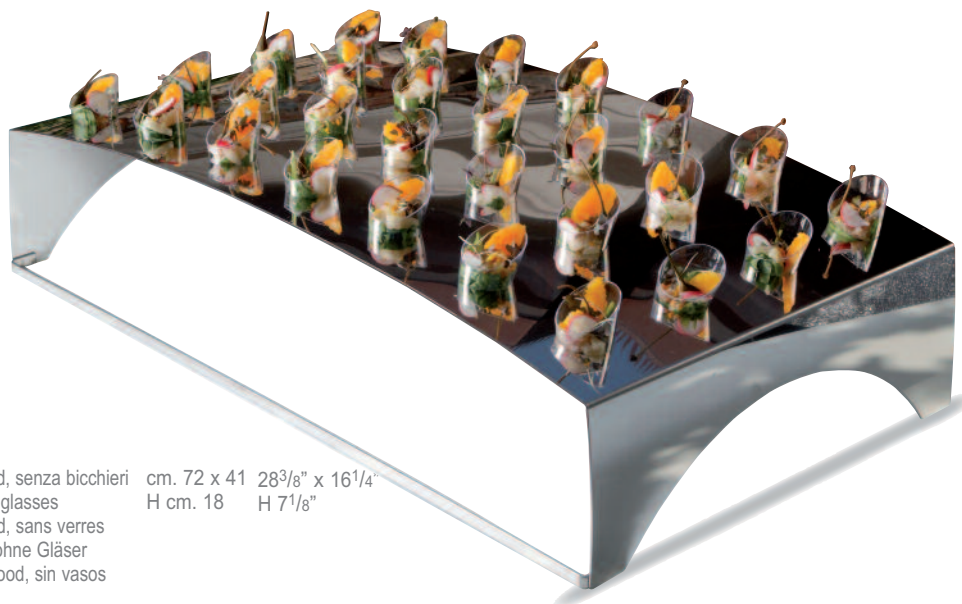

mm. 1,2 Espositore buffet per finger food, senza bicchieri
Buffet set for finger food, w/out glasses
Service à buffet pour finger food, sans verres
Buffet Display für Finger food, ohne Gläser
Servicio para buffet por finger food, sin vasos

cm. 72 x 41 28 3/8" x 16 1/4"
H cm. 18 H 7 1/8"

563

560



mm. 1,2 Quadro piano
Square tray
Plateau carré
Tablett, quadratisch
Bandeja cuadrada

cm. 15 x 15 5 7/8" x 5 7/8"
cm. 22 x 22 8 5/8" x 8 5/8"



mm. 1,2 Tondo fondo
Round bowl
Bol ronde
Obstschale, rund
Cuenco redondo

Ø cm. 12 cl. 26 Ø 4 3/4" oz. 8 3/4
Ø cm. 15 cl. 60 Ø 5 7/8" oz. 20 1/4
Ø cm. 22 cl. 131 Ø 8 5/8" oz. 44 1/3
Ø cm. 32 lt. 3,0 Ø 12 5/8" oz. 101 2/5

B U F F E T



BUFFET





591P



Bicchiere
Glass
Gobelet
Glas
Vaso

H cm 13 H 5"
cl. 45 oz 15 1/4

588P



Bicchiere
Glass
Gobelet
Glas
Vaso

H cm 10 H 3 7/8"
cl. 33 oz. 11 1/8

1131



10521131

10521108

Mini Forchetta
Appetizer fork
Fourchette amouse
bouche
Minigabel
Mini tenedor

cm. 11,4 4 1/2"

Mini spoon cm. 11,4 4 1/2"

7012



Vassoio per canapè con bicchieri
Canape tray with glasses
Plateau à canape avec verres
Buffet Display mit Gläser
Bandeja para canapé con vasos

8 pz. 8 pcs
cm. 42 x 42 16 1/2" x 16 1/2"

17 pz. 17 pcs
cm. 42 x 72,5 16 1/2" x 28 1/2"

543N



Bicchiere per champagne
Champagne glass
Verre pour Champagne
Champagnerglas
Vaso por champán

H cm. 22,7 H 9"
cl. 15 oz. 5 1/8

555N



Piano per buffet
Tray for buffet
Plateau pour buffet
Buffettablett
Bandeja para buffet

Ø cm. 18 Ø 10 1/2"

543

A Ambra
Amber
Ambre
Amber
Ambar



G Granato
Garnet
Grenat
Granat
Granate



S Smeraldo
Emerald
Emeraude
Smaragd
Esmeralda



Z Zaffiro
Sapphyre
Saphir
Saphir
Zafiro



M Ametista
Amethyst
Amethyste
Amethyst
Amatista



W Trasparente
Transparent
Glace
Transparent
Vidrio



O Onice
Onyx
Onyx
Onyx
Onice



P Porcellana
White
Porcelain
Weiss
Porcelana



N Nero
Black
Noir
Schwarz
Negro



BUFFET

7199



PALACE
Chafing Dish rettangolare con coperchio girevole a 180°
Rectangular Chafing Dish with 180° revolving cover
Chafing Dish rectangulaire avec couvercle basculant à 180°
Chafing Dish rechteckig mit 180° Rollhaube
Chafing Dish rectangular con tapa volvíble à 180°

cm. 66 x 45
H cm. 43
Lt. 6,5

26" x 17 3/4"
H 17"
gal. 1 3/4

7199A



cm. 52 x 32
20 1/2" x 12 3/4"

PALACE
Zuppiera per art. 7199
Soup station for art. 7199
Marmite à potage pour art. 7199
Suppenstation für Art. 7199
Sopera para art. 7199

Ø cm. 21,5 Ø 8 1/2"

7201



PALACE
Chafing Dish tondo con coperchio girevole a 180°
Round Chafing Dish with 180° revolving cover
Chafing Dish rond avec couvercle basculant à 180°
Chafing Dish rund mit 180° Rollhaube
Chafing Dish rendono con tapa volvíble à 180°

Ø cm. 40
H cm. 46
Lt. 4,5

Ø 15 3/4"
H 18 1/8"
gal. 1 1/4

Ø cm. 38,5 esterno
Ø cm. 22 interno

Ø 15 1/8" outside
Ø 8 3/4" inside

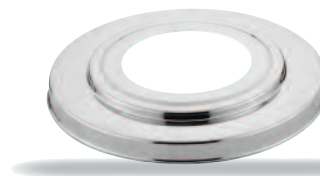

7201A

Ø cm. 21,5 Ø 8 1/2"

PALACE
Zuppiera per art. 7201
Soup station for art. 7201
Marmite à potage pour art. 7201
Suppenstation für Art. 7201
Sopera para art. 7201

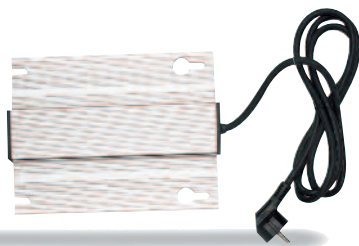

Piastra elettrica per art. 7199
Electric Heater for art. 7199
Element de chauffage électrique pour art. 7199
Heizelement für Art. 7199
Calientador eléctrico para art. 7199

7199B 110V
7199C 220V

cm. 25 x 19
9 3/4" x 7 1/2"

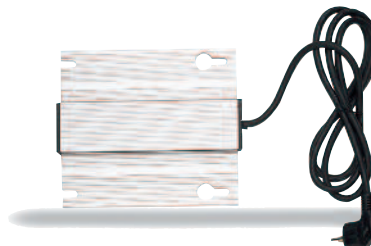

Piastra elettrica per art. 7201
Electric Heater for art. 7201
Element de chauffage électrique pour art. 7201
Heizelement für Art. 7201
Calientador eléctrico para art. 7201

7201B 110V
7201C 220V

cm. 21,5 x 18,5
8 1/2" x 7 1/4"

151



mm. 1,2 Vassoio rettangolare
Rectangular tray
Plateau de presentation
Tablett, rechteckig
Bandeja rectangular

cm. 63 x 45
24 11/16" x 17 3/4"

7204



Coffee Urn	PALACE	Ø cm. 32	gal. 2 ³ / ₄
Coffee Urn	"	H cm. 60	H 23 ⁵ / ₈ "
Bouilleur	"	lt. 11	Ø 12 ⁵ / ₈ "
Kaffeespender	"	Ø cm. 32	Ø 12 ⁵ / ₈ "
Contenedor para café	"	H cm. 67	H 26 ³ / ₈ "
		lt. 19	gal. 5

7206



Distributore per succo di frutta	PALACE	cm. 26 x 35	10 1/4" x 13 3/4"
Juice dispenser	"	H cm. 58	H 22 7/8"
Distributeur à jus	"	lt. 7	gal. 1 7/8
Saftdispenser	"		
Contenedor para zumo de fruta	"		

7208



Doppio distributore per succo di frutta	PALACE	cm. 56 x 35
Double Juice dispenser	"	H cm. 58
Double distributeur à jus	"	lt. 14
Doppel Saftdispenser	"	22" x 13 3/4"
Doble contenidor para zumo de fruta	"	H 22 7/8"
		gal. 3 1/2

HAPPY

10001175



10001123

Nuovo sistema per il servizio delle pietanze, per evitare la caduta delle posate all'interno degli chafing. Tutta la collezione HAPPY è a pag. 98.

10001122

A new collection of serving pieces designed with a handle that securely rests on the edge of the chafing dish when not in use. The entire Happy collection can be found on page 98.

10001111

Nouveau système pour le service des plats, pour éviter la chute des couverts à l'intérieur des chafing. Toute la collection HAPPY est au pag. 98.

10001110

"HAPPY" ist eine neue platzsparende Idee, wie man von Chafing Dishes Speisen auf Teller füllen kann, ohne dass die Servierteile hineinfallen. Gesamte HAPPY Kollektion auf Seite 98.

10001142

Nuevo sistema por el servicio de las comidas, para evitar la caída de los cubiertos dentro de los chafing. Toda la colección HAPPY es a pag. 98.



10001116

Apoggia posate
Knife rest
Soutier p/couverts
Messer bank
Apoyo p/cubiertos

Ø mm.10

Largh. cm 6,5
Width 2 1/2"

BUFFET

7087



Chafing Dish 1/1 rettangolare con coperchio amovibile cm. 61 x 30 24" x 11 3/4"
 Rectangular Chafing Dish 1/1 with removable cover H cm. 32,5 H 12 3/4"
 Chafing Dish 1/1 rectangulaire avec couvercle démontable lt. 6,5 gal. 1 3/4
 Chafing Dish 1/1 rechteckig mit abnehmbarer Haube
 Chafing Dish 1/1 rectangular con tapa amovible

7086

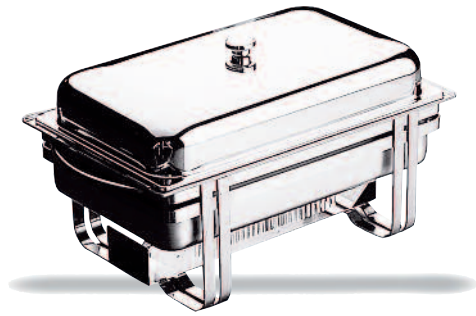

GIOTTO Chafing Dish 1/1 rettangolare con coperchio amovibile cm. 61 x 30
 Rectangular Chafing Dish 1/1 with removable cover H cm. 32,5
 Chafing Dish 1/1 rectangulaire avec couvercle démontable lt. 6,5
 Chafing Dish 1/1 rechteckig mit abnehmbarer Haube 24" x 11 3/4"
 Chafing Dish 1/1 rectangular con tapa amovible H 12 3/4"
 gal. 1 3/4

7090



mm. 0,8 Rinfrescatore per yogurt cm. 52,5 x 32,5 20 5/8" x 12 3/4"
 Yogurt cooler lt. 8 gal. 2
 Rafrachisseur à yaourts
 Yoghurtkühler
 Refrigerador para yogurt

236



mm. 1,2 Rinfrescatore per yogurt Ø cm.38
 Yogurt cooler H cm. 9
 Rafrachisseur à yaourts lt. 3,0 Ø 15"
 Yoghurtkühler H 3 1/2"
 Refrigerador para yogurt oz. 101 2/5

BUFFET

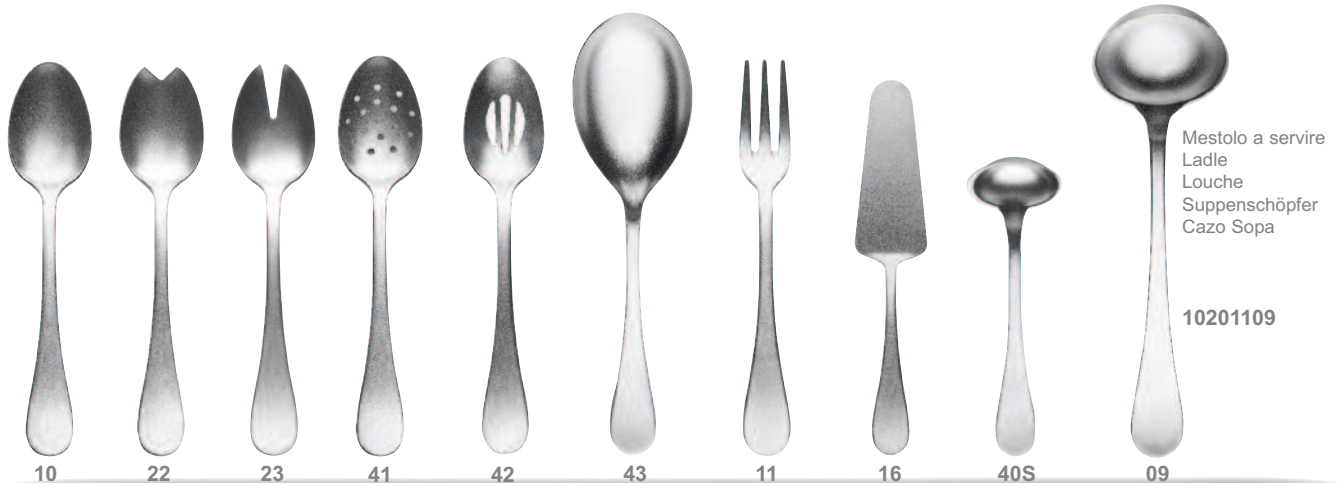

10

22

23

41

42

43

11

16

40S

09

Cucchiaione
 Cooking spoon
 Cuillère à légumes/
 à ragût
 Gemüselöffel
 Cuchara legumbres

Cucchiaio nsalata
 Salad serving
 spoon
 Cuillère à salade
 servir
 Salatvorlegelöffel
 Cuchara servir
 ensalada

Forchetta Insalata
 Salad serving fork
 Fourchette
 à salade servir
 Salatvorlegegabel
 Tenedor servir
 ensalada

Cucchiaione
 con fori
 Serving spoon
 w/holes
 Cuillère a/trous
 Servierlöffel
 m/Löchern
 Cuchara
 c/agujeros

Cucchiaione
 con asole
 Serving spoon
 w/slots
 Cuillère a/oieilles
 Servierlöffel
 m/Ösen
 Cuchara
 c/ojales

Cucchiaio risotto
 "Risotto" spoon
 Cuillère "Risotto"
 Reislöffel
 Cuchara arroz seco

Forchettone a servire
 Serving fork
 Fourchette à légumes/
 à servir
 Fleischgabel
 Tenedor legumbres

Pala per Torta
 Cake trowel
 Pelle à tarte
 Tortenheber
 Pala tarta

Mestolo a servire
 Ladle
 Louche
 Suppenschöpfer
 Cazo Sopa

10201109

10201110

10201122

10201123

10201141

10201142

10201143

10201111

10201116

10201140S

7999

7999



"MATHUSALEM"
lt. 6 - gal. 1 1/2

"SALMANAZAR"
lt. 9 - gal. 2 1/2

Culla portachampagne "MATHUSALEM" lt. 6 - gal. 1 1/2
 Champagne holder "SALMANAZAR" lt. 9 - gal. 2 1/2
 Porte-champagne
 Champagnerflaschenhalter cm 45 x 31 - H cm 65
 Portabotella de champagne 17 3/4" x 12 1/4" - H 25 1/2"

NEW

BUFFET

NEW

769



Molla per zucchero ed aperitivi
Sugar and cocktails tongs
Pince à sucre et apéritifs
Zucker- und Cocktailszange
Pinzas azúcar y aperitivos
mm. 1,2

Lungh. cm. 10,8

Length 4 1/4"

768



Molla per Finger food
Finger food tongs
Pince à amuse-bouche
Fingerfoodzange
Pinzas por finger food
mm. 1,2

Lungh. cm. 15

Length 6"

766



Molla per ghiaccio e limone
Ice and lemon tongs
Pince à glaçon et citron
Eis- und Zitronenzange
Pinzas hielo y limón

Lungh. cm. 15

Length 6"

767



Molla per pasticceria
Pastry tongs
Pince à gateaux
Gebäckzange
Pinzas dulces
mm. 1,2

Lungh. cm. 18

Length 7"

763



Molla per pane e dolci
Bread and cakes tongs
Pince à pain et gateaux
Brot- und Süßenzange
Pinzas para pan y dulces
mm. 1,2

Lungh. cm. 22

Length 8 2/3"

765



Molla per arrosto e verdure
Roasts and vegetables tongs
Pince à salade et à rôti
Servierzange
Pinzas asado y verduras
mm. 1,2

Lungh. cm. 22

Length 8 2/3"

760



Molla per spaghetti
Spaghetti/Pasta tongs
Pince à spaghetti
Spaghettizange
Pinzas spaghetti
mm. 1,2

Lungh. cm. 27

Length 10 3/5"

761



Molla piana per servire
Flat serving tongs
Pince plane pour servir
Flachzange zum Servieren
Pinzas llanas para servir
mm. 1,2

Lungh. cm. 27

Length 10 3/5"

762



Molla fonda per servire
Deep serving tongs
Pince fonde pour servir
Tiefzange zum Servieren
Pinzas fundas para servir
mm. 1,2

Lungh. cm. 26,5

Length 10 2/5"





Palace

964



mm. 1,2 Vassoio rettangolare con maniglie
Rectangular Tray with handles
Plateau rectangulaire avec anses
Tablett rechteckig mit Griffen
Bandeja rectangular con asas

cm. 40x27	15 ³ / ₄ " x 10 ⁵ / ₈ "
cm. 45x31	17 ³ / ₄ " x 12 ¹ / ₄ "
cm. 50x34	19 ⁵ / ₈ " x 13 ³ / ₈ "
cm. 60x42	23 ⁵ / ₈ " x 16 ¹ / ₈ "

963GN



mm. 1,2 Vassoio rettangolare gastronomico
Rectangular gastronomic Tray
Plateau rectangulaire gastronomico
Tablett rechteckig gastronomico
Bandeja rectangular gastronomico

cm. 53 x 32,5	20 ³ / ₄ " x 12 ² / ₃ "
---------------	---

963



mm. 1,2 Vassoio rettangolare
Rectangular Tray
Plateau rectangulaire
Tablett rechteckig
Bandeja rectangular

cm. 30x21	11 ³ / ₄ " x 8 ¹ / ₄ "
cm. 35x24	13 ³ / ₄ " x 9 ¹ / ₂ "
cm. 40x27	15 ³ / ₄ " x 10 ⁵ / ₈ "
cm. 45x31	17 ³ / ₄ " x 12 ¹ / ₄ "
cm. 50x34	19 ⁵ / ₈ " x 13 ³ / ₈ "
cm. 60x42	23 ⁵ / ₈ " x 16 ¹ / ₈ "

966



mm. 1,2 Vassoio tondo
Round Tray
Plateau rond
Tablett rund
Bandeja redonda

Ø cm. 13	Ø 5 1/8"
Ø cm. 19	Ø 7 1/2"
Ø cm. 24	Ø 9 1/2"
Ø cm. 27	Ø 10 5/8"
Ø cm. 35	Ø 13 3/4"
Ø cm. 40	Ø 15 3/4"

965



mm. 1,2 Vassoio rettangolare con piedini
Rectangular Tray with feet
Plateau rectangulaire avec socles
Tablett rechteckig mit Füßen
Bandeja rectangular con 4 pies

cm. 30x21	11 ³ / ₄ " x 8 ¹ / ₄ "
cm. 35x24	13 ³ / ₄ " x 9 ¹ / ₂ "
cm. 40x27	15 ³ / ₄ " x 10 ⁵ / ₈ "
cm. 45x31	17 ³ / ₄ " x 12 ¹ / ₄ "
cm. 50x34	19 ⁵ / ₈ " x 13 ³ / ₈ "
cm. 60x42	23 ⁵ / ₈ " x 16 ¹ / ₈ "

967



mm. 1,2 Vassoio tondo con piedini
Round Tray with feet
Plateau rond avec socles
Tablett rund mit Füßen
Bandeja redonda con 4 pies

Ø cm. 27	Ø 10 5/8"
Ø cm. 35	Ø 13 3/4"
Ø cm. 40	Ø 15 3/4"

950



mm. 1,2	Ciotola con base	Ø cm. 14	cl. 60	Ø 5 1/2"	oz. 20 1/4
	Bowl with base	H cm. 8,8		H 3 1/2"	
	Bol avec socle	Ø cm. 20	lt. 1,8	Ø 7 7/8"	oz. 60 7/8
	Obstschale auf Fuss	H cm. 11		H 4 1/2"	
	Cuenco con pedestal	Ø cm. 24	lt. 3,1	Ø 9 1/2"	oz. 104 7/8
		H cm. 14		H 5 1/2"	
		Ø cm. 28	lt. 5,1	Ø 11"	gal. 1 1/4
		H cm 16		H 6 1/3"	

977



mm. 1,2	Porta pasticcini	Ø cm 13	Ø 5 1/8"
	Petit-fours stand	H cm 10,5	H 4 1/8"
	Porte-petit fours		
	Petits Fours-Ständer	Ø cm 19	Ø 7 1/2"
	Porta dulces	H cm 14	H 5 1/2"

981A



mm. 1,2	Alzata portafrutta rettang. 2 piani	cm 35x24	13 3/4" x 9 1/2"
	Rectangular fruit holder 2 layers	cm 45x31	17 3/4" x 12 1/4"
	Serviteur rectangulaire 2 etages	H cm 50	H 19 5/8"
	Etagere, rechteckig 2-stufig		
	Frutero rectangular 2 pisos		

981B



mm. 1,2	Alzata portafrutta rettang. 3 piani	cm 35x24	13 3/4" x 9 1/2"
	Rectangular fruit holder 3 layers	cm 45x31	17 3/4" x 12 1/4"
	Serviteur rectangulaire 3 etages	cm 60x42	25 5/8" x 16 1/8"
	Etagere, rechteckig 3-stufig	H cm 73	H 28 3/4"
	Frutero rectangular 3 pisos		

978



mm. 1,2 Porta pasticcini a 2 piani
Petit-fours stand 2 layers
Porte-petit fours 2 etages
Mokkaétagère 2 Ebenen
Porta dulces 2 pisos

Ø cm. 13	Ø 5 1/8"
Ø cm. 19	Ø 7 1/2"
H cm. 29	H 11 3/8"

97803



mm. 1,2 Porta pasticcini a 3 piani
Petit-fours stand 3 layers
Porte-petit fours 3 etages
Mokkaétagère 3 Ebenen
Porta dulces 3 pisos

Ø cm 13	Ø 5 1/8"
Ø cm 19	Ø 7 1/2"
Ø cm 27	Ø 10 3/8"
H cm 36	H 14 1/4"

980B



mm. 1,2 Alzata portafrutta tonda 3 piani
Round fruit holder 3 layers
Serviteur rond 3 etages
Etager, rund 3-stufig
Frutero redondo 3 pisos

Ø cm 27	Ø 10 5/8"
Ø cm 35	Ø 13 3/4"
Ø cm 40	Ø 15 3/4"
H cm 73	H 28 3/4"

980A



mm. 1,2 Alzata portafrutta tonda 2 piani
Round fruit holder 2 layers
Serviteur rond 2 etages
Etager, rund 2-stufig
Frutero redondo 2 pisos

Ø cm 27	Ø 10 5/8"
Ø cm 35	Ø 13 3/4"
H cm 50	H 19 5/8"

928



mm. 1,2 Vassoio rettangolare da servizio
 Rectangular service tray
 Plateau rectangulaire pour service
 Tablett rechteckig für Service
 Bandeja rectangular da servicio

cm. 30x21	11 ³ / ₄ " x 8 ¹ / ₄ "
cm. 35x24	13 ³ / ₄ " x 9 ¹ / ₂ "
cm. 40x27	15 ³ / ₄ " x 10 ⁵ / ₈ "
cm. 45x31	17 ³ / ₄ " x 12 ¹ / ₄ "
cm. 50x34	19 ⁵ / ₈ " x 13 ³ / ₈ "
cm. 60x42	23 ⁵ / ₈ " x 16 ¹ / ₈ "

927



mm. 1,2 Vassoio tondo da servizio
 Round service tray
 Plateau rond pour service
 Tablett rund für Service
 Bandeja redonda por servicio

Ø cm. 27	Ø 10 ⁵ / ₈ "
Ø cm. 35	Ø 13 ³ / ₄ "
Ø cm. 40	Ø 15 ³ / ₄ "

959



960



982



958



Coppa in vetro c/piedistallo
 Glass bowl with base
 Coupe ronde en verre a/socle
 Glassobstschale rund auf Fuß
 Cuenco redondo en vidrio c/pedestal

959
 Ø cm 21,5
 H cm 29
 cl. 270

960
 Ø cm 12
 H cm 17
 cl. 45

959
 Ø 8¹/₂"
 H 11³/₈"
 oz. 91³/₈

960
 Ø 4³/₄"
 H 6³/₄"
 oz. 15¹/₄

Piatto da torta in vetro c/piedistallo
 Glass cake plate with base
 Plat pour gateau en verre a/socle
 Kuchenplatte aus Glas auf Fuss
 Plato para tarta en vidrio c/pedestal

Ø cm 33
 H cm 16
 Ø 12³/₄"
 H 6¹/₄"

Coppa multiservizio
 Glass bowl with sauce cap
 Coupe multifonctions
 Universalschale
 Ensaladera multiservicio

Ø cm 28
 H cm. 14
 cl. 300
 Ø 11"
 H 5¹/₂"
 oz. 101¹/₂

938



mm. 1,2 Vassoio ovale
 Oval tray
 Plateau oval
 Tablett oval
 Bandeja oval

cm. 31 x 22 12¹/₈" x 8³/₄"

937



mm. 1,2 Cestino per pane
 Oval basket
 Corbeille oval
 Brotkorb oval
 Frutero oval

cm. 31 x 22 12¹/₈" x 8³/₄"
 lt. 1,7 oz. 57¹/₂

968



mm. 2,0 Ampolla e formaggera
Cruet and cheese basin
Huillière et fromagère
Essig-Ölflasche und Käsedose
Vinagrera y quesera

cl. 22
H cm 15
oz. 7 1/2
H 5 7/8"

cl. 20
oz. 6 3/4

970



mm. 2,0 Salino e porta stuzzicadenti
Salt-cellar and toothpick container
Salière et porte cure-dents
Salzstreuer und Zahnstocherbehälter
Salero y palillero

cl. 8
H cm. 9
oz. 2 3/4
H 3 1/2"

971

975



mm. 1,2 Chillcup
Caviar dish
Bol à caviar
Chillcup / Kaviarschale
Bol para caviar

cl. 15
Ø cm 19
oz. 5 1/8
Ø 7 1/2"

mm. 1,2 Servizio per antipasto
Snack server
Support à snacks
Relish-Pickles-Gestell
Entremesera

Ø cm. 20
H cm 15
cl. 15 (x3)
Ø 7 7/8"
H 5 7/8"
oz. 5 1/8 (x3)

976



935



mm. 1,2 Porta macaron
Macarons server
Porte macarons
Macaronsträger
Porta macaron

Ø cm 15
H cm 10
Ø 5 7/8"
H 4"

976C



mm. 1,2 Portasalatini impilabile
Stackable snack server
Support à snack empilable
Stapelbare Relish-Pickles-Gestell
Servicio por entremes impilable

Ø cm. 20
cl. 15 (x3)
Ø 7 7/8"
oz. 5 1/8 (x3)
976C
Ø cm. 20
H cm 15
cl. 15 (x3)
976C
Ø 7 7/8"
H 5 7/8"
oz. 5 1/8 (x3)

976S

951



mm. 1,2 Caffettiera con piedistallo
Coffee pot with base
Cafetière avec socle
Kaffekanne auf Fuss
Cafetera con pedestal

Tazze	4	cl 34	oz 12 ¹ / ₃
Cups	6	cl 52	oz 17 ² / ₃
Bols			
Tassen			
Tazas			

952



mm. 1,2 Teiera con piedistallo
Tea pot with base
Théière avec socle
Teekanne auf Fuss
Tetera con pedestal

Tazze	2	cl 37	oz 13
Cups	6	cl 60	oz 21
Bols			
Tassen			
Tazas			

953



mm. 1,2 Lattiera con piedistallo
Milk jug with base
Pot à lait avec socle
Milchkanne auf Fuss
Jarra lechera con pedestal

Tazze	2	cl 24	oz 8
Cups	4	cl 34	oz 12 ¹ / ₃
Bols			
Tassen			
Tazas			

954



mm. 1,2 Zuccheriera con piedistallo
Sugar bowl with base
Sucrier avec socle
Zuckerdose auf Fuss
Azucarero con pedestal

Tazze	6	cl 27	oz 10
Cups			
Bols			
Tassen			
Tazas			

957



mm. 1,2 Portabustine da zucchero
Sugar packet holder
Pot à sucre
Zuckerstangengefäß
Azucarera

Ø cm 7	H cm 9,5
Ø 2 ³ / ₄ "	H 3 ³ / ₄ "

914



mm. 1,2 Vassoietto
Tray
Plateau
Tablett
Bandeja

cm. 13 x 7
5 1/9" x 2 3/4"

982



mm. 1,2 Alzata portafrutta
Fruit holder
Serveur
Obstschale
Frutero

Ø cm 27	H cm. 15
Ø 10 ⁵ / ₈ "	H 5 ⁷ / ₈ "

247

247



Ø cm*	Ø in*
7,5	3"
10	4"
10,5	4 1/16"
13	5 1/16"
13,2	5 1/5"
14	5 1/2"
14,5	5 5/7"
20	7 7/8"
22	8 5/8"
24	9 1/2"
26	10 1/4"
28	11"
30	11 3/4"
31	12 1/8"
32	12 5/8"
33	13"

mm. 0,8 Cloche con pomolo
Cloche with knob
Cloche
Tellercloche
Tapa con pomo

* Tabella diametri misurati al bordo del piatto
* Table of diameters, measured at the edge of the plate

984

974

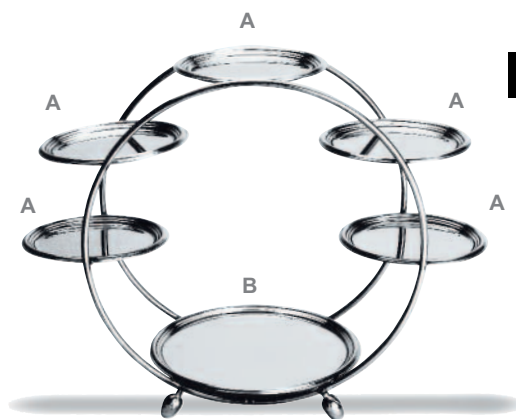
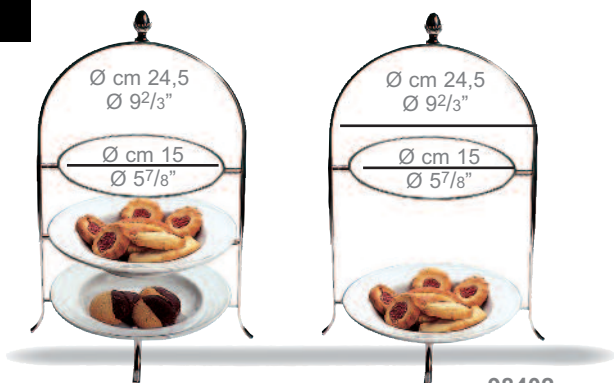

	984	984	98402	
Alzata portapiatti	Ø cm 24	Ø 9 1/2"	Ø cm 24	Ø 9 1/2"
Afternoon tea stand	H cm.43	H 16 7/8"	H cm.43	H 16 7/8"
Présentoir à gateau	985	985		
Dessert-Serviergestell	Ø cm 21	Ø 8 1/4"		
Soporte platos	H cm.37	H 14 1/2"		
	989	989		
	Ø cm 30	Ø 11 3/4"		
	H cm.50,5	H 19 7/8"		

mm. 1,2 Presentoire
2 misure
2 sizes
2 tailles
2 Größen
2 tamaños

A Ø cm.13 (x5)	A Ø 5 1/8" (x5)
B Ø cm.19	B Ø 7 1/2"
A Ø cm.19 (x5)	A Ø 7 1/2" (x5)
B Ø cm.27	B Ø 10 5/8"

7092

7094



7092
Candelabro a 1 fiamma
Candlestick
Chandelier
Leuchter 1-flammig
Candelabro
Silverplated
H cm. 28,5
H 11 1/4"

7093
Candelabro a 3 fiamme
Candelabra, 3 arms
Chandelier 3 flammes
Leuchter 3-flammig
Candelabro 3 luces
Silverplated
H cm. 34,5
H 13 5/8"

7094
Candelabro a 5 fiamme
Candelabra, 5 arms
Chandelier 5 flammes
Leuchter 5-flammig
Candelabro 5 luces
Silverplated
H cm. 34,5
H 13 5/8"

972



972

mm. 1,2
972-972P
 Secchiello per ghiaccio
 Ice bucket
 Seau à glaçons
 Eisgefäß
 Cubitera hielo



973

Ø cm 15 Ø 5 7/8"
 H cm 18 H 7 1/8"
 cl.150 oz. 50 3/4

973



973P

mm. 1,2
973-973P
 Secchiello per spumante
 Sparkling wine cooler
 Seau à champagne
 Wein- und Sektkühler
 Cubo para champany



972P

Ø cm 20,5 Ø 8 1/8"
 H cm 24,5 H 9 5/8"
 cl.500 gal. 1 1/3

666F

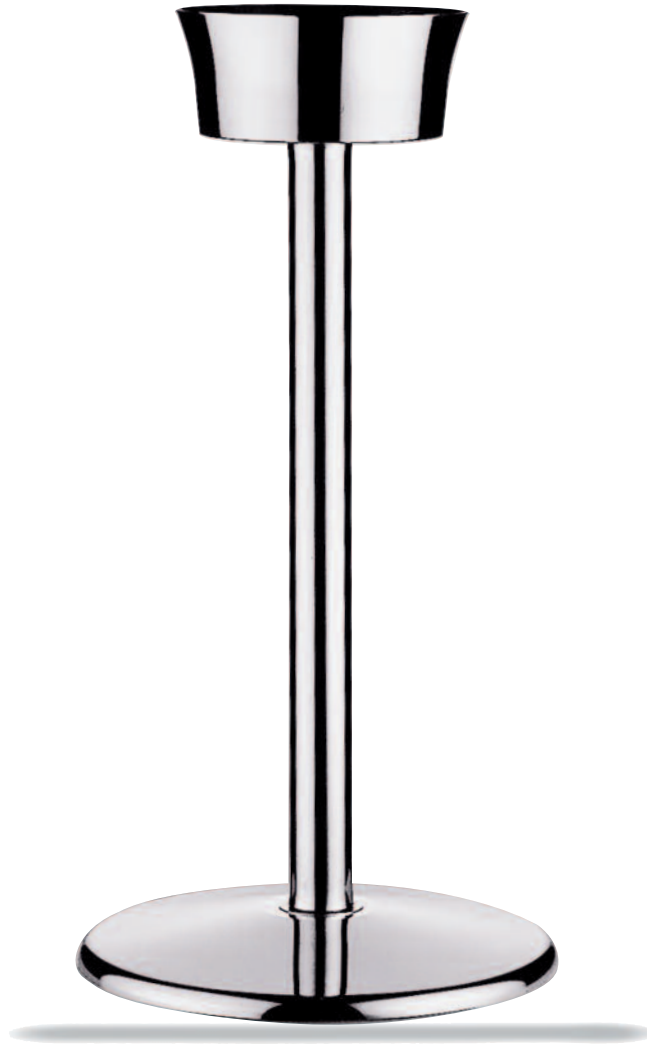

mm. 1,2
 Colonna portasecchiello spumante
 Wine cooler stand w/weighted base
 Pied pour seau à champagne
 Weinkühlerständer
 Columna porta cubo champany

H cm. 67,5 H 26 5/8"

657



mm. 0,8 Coppa per champagne con inserto
Champagne bowl with insert
Vasque a champagne avec anneau porte-verre
Champagner Bowl mit Gläser - Flaschenring
Copa para champagne con anillo

Ø cm. 38	Ø 15"
H cm. 29,5	H 11 5/8"
lt. 15	gal. 4

949



mm. 1,2 Supporto per informazioni o menu
Menu / Card holder
Porte nom numéro de table
Karten-Speisekartenhalter
Porta informaciones o menu

Ø cm. 10	Ø 4"
H cm. 10	H 4"

986



mm. 0,8 Alzata per crudité rettangolare
Rectangular seafood presentation
Serviteur à poisson crude rectang.
Etagere, rech., für marinierte Fisch
Porta pescado rectangular

cm. 53 x 32,5	20 3/4" x 12 2/3"	mm. 2,0
H cm. 9	H 3 1/2"	
lt. 9,0	gal. 2	

Portanumero
Table number stand
Numbers etched to order
Porte numéro de table
Tischnummernständer
Porta numero de mesa

A	A
Ø cm 13	Ø 5 1/8"
H cm 54	H 21 1/4"
B	B
Ø cm 13	Ø 5 1/8"
H cm 30	H 11 7/8"

995



987



mm. 0,8 Alzata per crudité rettangolare
Elevated rectangular seafood presentation
Serviteur à poisson crude rectang.
Etagere, rech., für marinierte Fisch
Porta pescado rectangular

cm. 53 x 32,5	20 3/4" x 12 2/3"
H cm. 25,8	H 10 1/7"
lt. 9,0	gal. 2

253



mm. 0,8 Rinfrescatore con piedini
Yogurt cooler with feet
Rafrachisseur à yaourts a/socles
Yoghurtkühler mit Füßen
Refrigerador para yogurt con pies

Ø cm 35	Ø 13 3/4"
H cm. 12	H 4 3/4"
lt. 2,0	oz. 67 3/5

983

944



mm. 1,2 Zuppiera
 Soup tureen
 Soupière
 Suppenterrine
 Sopera

Ø cm. 14 - lt. 0,6	Ø 5 1/2" - oz. 20 1/4
Ø cm. 18 - lt. 1,2	Ø 7" - oz. 40 5/8
Ø cm. 20 - lt. 1,8	Ø 7 7/8" - oz. 60 7/8
Ø cm. 22 - lt. 2,5	Ø 8 5/8" - oz. 84 1/2
Ø cm. 24 - lt. 3,1	Ø 9 1/2" - oz. 104 7/8
Ø cm. 26 - lt. 3,9	Ø 10 1/4" - oz. 131 7/8
Ø cm. 28 - lt. 5,1	Ø 11" - gal. 1 1/4

945



mm. 1,2 Legumiera
 Vegetable dish
 Légumière
 Lègumier
 Legumbrera

Ø cm. 14 - lt. 0,6	Ø 5 1/2" - oz. 20 1/4
Ø cm. 18 - lt. 1,2	Ø 7" - oz. 40 5/8
Ø cm. 20 - lt. 1,8	Ø 7 7/8" - oz. 60 7/8
Ø cm. 22 - lt. 2,5	Ø 8 5/8" - oz. 84 1/2
Ø cm. 24 - lt. 3,1	Ø 9 1/2" - oz. 104 7/8
Ø cm. 26 - lt. 3,9	Ø 10 1/4" - oz. 131 7/8
Ø cm. 28 - lt. 5,1	Ø 11" - gal. 1 1/4

946



mm. 1,2 Coperchio per art. 944 - 945
 Lid for art. 944 - 945
 Couvercle pour art. 944 - 945
 Deckel für art. 944 - 945
 Tapa para art. 944 - 945

Ø cm. 14	Ø 5 1/2"
Ø cm. 18	Ø 7"
Ø cm. 20	Ø 7 7/8"
Ø cm. 22	Ø 8 5/8"
Ø cm. 24	Ø 9 1/2"
Ø cm. 26	Ø 10 1/4"
Ø cm. 28	Ø 11"

936



Cloche trasparente con pomolo
 Transparent cloche with knob
 Cloche transparente
 Transparent Teller cloche
 Tapa transparente

Ø cm. 12	Ø 4 3/4"
Ø cm. 22	Ø 8 1/2"
Ø cm. 28	Ø 11"

940



mm. 1,2 Servizio per caffè macchiato
 Café au lait set
 Service pour café au lait
 Café au lait-Set
 Juego café au lait

939	939
H cm 18	H 7 1/8"
cl. 90	oz. 30 1/2
940	940
H cm 18	H 7 1/8"
cl. 97	oz. 32 7/8

940E
 Inserto per art. 940
 Insert for art. 940
 Insért pour art. 940
 Einsatz für Art. 940
 Inserto por art. 940

940E



mm. 1,2 Servizio per caffè macchiato
 5pcs Sugar, milk and coffee set
 Service sucre, lait et café 5 pièces
 Milch-Kaffee-Zucker Set 5-Tlg.
 Juego leche, café y azucar 5 piezas

H cm 18	H 7 1/8"
cl. 30 (x5)	oz. 10 1/8 (x5)

94005



943



mm. 1,2 Spargisale, portastecchi
Salt & Pepper
Sel/poivre/porte cure-dents
Salz-Pfeffer-Zahnstocherbehälter
Saleros y pimentero y palillero

H cm. 15 H 5 7/8"
cl. 7,5 (x 2) oz. 2 1/2 (x 2)

942



mm. 1,2 Oliera
Cruet
2 pièces huile-vinaigre
Essig-/Ölgestell
Vinagreras

H cm. 22 H 8 5/8"
cl. 22,5 (x 2) oz. 7 1/2 (x 2)

988



mm 1,2 Portamarmellata a 3 scomparti
Jam pack holder 3 compartment
Porte-confiture 3 comp.
Marmeladgestell 3 Einsätze
Marmeladero 3 comp.

H. cm. 15 H 5 7/8"
cl. 28 (x3) oz. 9 1/2 (x3)

990



mm 1,2 Coppetta con vassoio
Cup and tray
Coupe avec plateau
Schale mit Tablett
Cuenco con bandeja

H cm. 11,5 H 4 1/2"
Ø cm. 10 Ø 3 7/8"

947



Versatore per profumo a goccia
Perfume drops dispenser
Verseur de parfum en gouttes
Tropf-Parfüm Aussteller
Versador de perfume en gotas

Lungh. cm 18,5
Length 7 5/8"

94003



mm. 1,2 Servizio per zucchero 3 e 4 pezzi
Sugar set 3 and 4 pcs.
Service pour sucre 3 et 4 pièces
Sahne-/Zucker-Set 3- und 4-Tlg
Juego azucar 3 y 4 piezas

H cm. 15 H 5 7/8"
cl. 11 (x3) oz. 3 3/4 (x3)
cl. 11 (x4) oz. 3 3/4 (x4)

94004



mm. 1,2 Mini burriera con coperchio
Small butter dish w/lid
Petit beurrier a/couvercle
Mini Butterdose m/Deckel
Platillo para mantequilla
con tapa

cm. 12 x 6 4 3/4" x 2 1/3"
cl. 15 oz. 5 1/8

922



Giotto

257



mm. 1,2	Porta pasticcini con piedistallo	Ø cm. 14	Ø 5 1/2"
	Petit-fours stand with base	H cm. 8,7	H 3 1/2"
	Porte-petits-fours avec socle	Ø cm. 20	Ø 7 7/8"
	Petits Fours-Ständer	H cm. 13	H 5 1/8"
Porta dulces con pedestal		Ø cm. 28	Ø 11"
		H cm. 14,5	H 5 3/4"

258



mm. 1,2	Porta pasticcini con piedistallo	Ø cm. 14	Ø 5 1/2"
	Petit-fours stand with legs	Ø cm. 20	Ø 7 7/8"
	Porte-petits-fours avec socle	Ø cm. 28	Ø 11"
	Mokkaétagère 3 Ebenen	H cm. 27	H 10 5/8"
Porta dulces con pedestal			

220



mm. 1,2	Coppa per punch	Ø cm. 38	Ø 15"
	Punch bowl	H cm. 32,3	H 12 5/7"
	Bol à punch	lt. 15	gal. 4
	Punch Bowl		
Ponchera			

255



mm. 1,2	Presentoire	25514	25514
	3 misure	A Ø cm.14 (x5)	A Ø 5 1/2" (x5)
	3 sizes	B Ø cm.20	B Ø 7 7/8" (x5)
	3 tailles	25520	25520
3 Größen	A Ø cm.20 (x5)	A Ø 7 7/8" (x5)	
3 tamaños	B Ø cm.24	B Ø 9 1/2" (x5)	
	25524	25524	
	A Ø cm.24 (x5)	A Ø 9 1/2" (x5)	
	B Ø cm.28	B Ø 11"	

7070



7070

7071



7072



7073



7073

Candelabro bugia Candlestick Chandelier Leuchter mit Kerze Candelabro	H cm. 13	Candelabro a 1 fiamma Candlestick Chandelier Leuchter 1-flammig Candelabro	H cm. 23,6	Candelabro a 3 fiamme Candelabra, 3 arms Chandelier 3 flammes Leuchter 3-flammig Candelabro 3 luces	H cm. 23,6	Candelabro a 5 fiamme Candelabra, 5 arms Chandelier 5 flammes Leuchter 5-flammig Candelabro 5 luces	H cm. 23,6
	H 5 1/8"		H 9 1/4"		H 9 1/4"		H 9 1/4"

141



mm. 1,2 NOVECENTO
Vassoio
Tray
Plateau
Tablett
Bandeja

cm. 30 x 21	11 3/4" x 8 1/4"
cm. 35 x 24	13 3/4" x 9 1/2"
cm. 40 x 27	15 3/4" x 10 5/8"
cm. 45 x 31	17 3/4" x 12 1/4"
cm. 50 x 34	19 5/8" x 13 3/8"
cm. 60 x 42	23 5/8" x 16 1/2"
cm. 80 x 54	31 1/2" x 21 1/4"

144



mm. 1,2 NOVECENTO
Vassoio con maniglie
Tray with handles
Plateau avec anses
Tablett mit Griffen
Bandeja con asas

cm. 40 x 27	15 3/4" x 10 5/8"
cm. 45 x 31	17 3/4" x 12 1/4"
cm. 50 x 34	19 5/8" x 13 3/8"
cm. 60 x 42	23 5/8" x 16 1/2"
cm. 80 x 54	31 1/2" x 21 1/4"

141GN



mm. 1,2 NOVECENTO
Gastronorm

1/1 GN	1/1 GN
cm. 53 x 32,5	20 7/8" x 12 2/3"

2/1 GN2	2/1 GN2
cm. 65 x 53	25 5/8" x 20 7/8"

144GN



mm. 1,2 NOVECENTO
Gastronorm con maniglie
Gastronorm with handles
Gastronorm avec anses
Gastronorm mit Griffen
Gastronorm con asas

1/1 GN
cm. 53 x 32,5
20 7/8" x 12 2/3"

2/1 GN2
cm. 65 x 53
25 5/8" x 20 7/8"

146GN



mm. 1,2 NOVECENTO
Gastronorm

1/1 GN	1/1 GN
cm. 53 x 32,5	20 7/8" x 12 2/3"

2/1 GN2	2/1 GN2
cm. 65 x 53	25 5/8" x 20 7/8"

146



mm. 1,2 Vassoio con maniglia sovrapponibile
Tray with stackable handles
Plateau avec anses empilables
Tablett mit stapelbaren Griffen
Bandeja con asas empilables

cm. 30 x 21	11 3/4" x 8 1/4"
cm. 35 x 24	13 3/4" x 9 1/2"
cm. 40 x 27	15 3/4" x 10 5/8"
cm. 45 x 31	17 3/4" x 12 1/4"
cm. 50 x 34	19 5/8" x 13 3/8"
cm. 60 x 42	23 5/8" x 16 1/2"
cm. 80 x 54	31 1/2" x 21 1/4"

137



mm. 1,2 Vassoio quadro NOVECENTO cm. 60 x 60 23 5/8" x 23 5/8"
 Square tray »
 Plateau carré »
 Tablett, quadratisch »
 Bandeja cuadrada »

256



mm. 1,2 Vassoio rotondo GIOTTO Ø cm. 27 Ø 10 5/8"
 Round tray » Ø cm. 35 Ø 13 3/4"
 Plateau rond » Ø cm. 40 Ø 15 3/4"
 Tablett rund »
 Bandeja redonda »

138



mm. 1,2 Vassoio quadro con maniglie NOVECENTO cm. 60 x 60 23 5/8"x23 5/8"
 Square tray with handles »
 Plateau carré avec anses »
 Tablett, quadratisch mit Griffen »
 Bandeja cuadrada con asas »

AIRLINES

140



mm. 1,2 Vassoio per compagnie aeree 200140 ATLAS
 Airlines tray for on board service cm. 38,5 x 27,5
 Ideal for aircraft and corporates jets 15 1/8" x 10 4/5"
 Chariot de service 200140K KSSU
 Bordservice -Tablett f. Airlines cm. 40,4 x 27,9
 Bandeja de servicio para comp. aéreas 15 7/8" x 11"

139



mm. 1,2 Vassoio quadr.c/man.sovrappon. cm. 60 x 60 23 5/8" x 23 5/8"
 Square tray w/stackable handles
 Plateau carré a/anses empliabiles
 Tablett quadr.m/stapelb. Griffen
 Bandeja cuadrada c/asas empil.

250

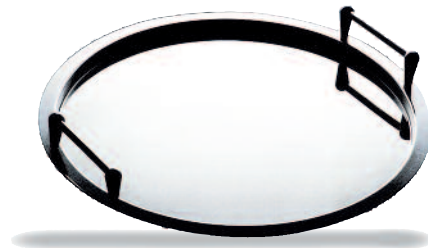

mm. 1,2 Vassoio con maniglia sovrapponibile Ø cm. 35 Ø 13 3/4"
 Tray with stackable handles Ø cm. 40 Ø 15 3/4"
 Plateau avec anses empliabiles
 Tablett mit stapelbaren Griffen
 Bandeja con asas empilables

295



mm. 1,2 Vassoio tondo con piedistallo Ø cm. 35 Ø 13 3/4"
 Round tray with base H cm. 12,5 H 4 7/8"
 Plateau rond avec socle
 Obstschale, rund auf Fuß
 Bandeja redonda con pedestal

297



mm. 1,2 Vassoio ovale con piedistallo cm. 45 x 30 17 3/4" x 11 3/4"
 Oval tray with base H cm. 12,5 H 4 7/8"
 Plateau oval avec socle
 Obstschale, oval auf Fuß
 Bandeja oval con pedestal

296



mm. 1,2 Vassoio rettang. con piedistallo cm. 45 x 30 17 3/4" x 11 3/4"
 Rectangular tray with base H cm. 12,5 H 4 7/8"
 Plateau rectang. avec socle
 Tablett, rechteckig auf Fuß
 Bandeja rectang. con pedestal

298



mm. 1,2 Piatto torta con piedistallo Ø cm. 40 Ø 15 3/4"
 Cakes plate with base H cm. 9,5 H 3 3/4"
 Plat à tarte avec socle
 Kuchenplatte auf Fuß
 Bandeja tarta con pedestal

287



mm. 2,0 Vassoio rettangolare per buffet cm. 30x21 11 3/4" x 8 1/4"
 Rectangular Tray for buffet cm. 40x27 15 3/4" x 10 5/8"
 Plateau rectangulaire pour buffet cm. 50x34 19 5/8" x 13 3/8"
 Buffet -Tablett, rechteckig cm. 60x42 23 5/8" x 16 1/8"
 Bandeja rectangular para entremes

288



mm. 2,0 Vassoio tondo per buffet Ø cm. 30 Ø 11 3/4"
 Round Tray for buffet Ø cm. 40 Ø 15 3/4"
 Plateau rond pour buffet Ø cm. 50 Ø 19 5/8"
 Buffet-Tablett rund Ø cm. 60 Ø 23 5/8"
 Bandeja redonda para entremes

7004A



mm. 0,8 Alzata per pesce crudo
Marinated fish holder
Serviteur à poisson crude
Etagere für marinierten Fisch
Porta pescado

Ø cm. 34 Ø 13 3/4"
Ø cm. 41 Ø 16 1/8"
H cm. 55 H 21 5/8"

7004B



mm. 1,2 Alzata per pesce crudo
Marinated fish holder
Serviteur à poisson crude
Etagere für marinierten Fisch
Porta pescado

Ø cm. 22 Ø 8 5/8"
Ø cm. 34 Ø 13 3/8"
H cm. 38 H 15"

7002B



mm. 1,2 Alzata portafrutta NOVECENTO cm. 35x24 13 3/4" x 9 1/2"
Fruit holder » cm. 45x31 17 3/4" x 12 1/4"
Serviteur » cm. 60x42 23 5/8" x 16 1/2"
Etagere » H cm. 70 H 27 5/8"
Frutero »

7001B



mm. 1,2 Alzata portafrutta GIOTTO Ø cm. 27 Ø 10 5/8"
Fruit holder » Ø cm. 35 Ø 13 3/4"
Serviteur » Ø cm. 40 Ø 15 3/4"
Etagere » H cm. 70 H 27 5/8"
Frutero »

67301



67304

mm. 1,2 Portaggiaccio termico con coperchio
 Insulated ice-bucket with lid
 Seau à glaçons thermique
 avec couvercle
 Isolier-Eisgefäß, mit Deckel
 Cubitera hielo térmica con tapa

Ø cm 14	Ø 5 1/2"
H cm 13,5	H 5 1/9"
lt. 0,70	oz. 23 2/3
Ø cm 24	Ø 9 1/2"
H cm 23	H 9"
lt. 2,75	oz. 93

668



669

mm. 1,2 Secchiello per spumante
 Sparkling wine cooler
 Seau à champagne
 Wein- und Sektkühler
 Cubo para champany

Ø cm 24	Ø 9 1/2"
H cm 23	H 9"
lt. 2,75	oz. 93
Ø cm 14	Ø 5 2/3"
H cm 13,5	H 5 1/9"
lt. 0,70	oz. 23 2/3

666E



mm. 1,2 Colonna portasecchiello spumante
 Wine cooler stand
 Pied pour seau à champagne
 Weinkühlerständer
 Columna porta cubo champany

H cm. 67,5	H 26 5/8"
------------	-----------

686



mm. 1,2 Champagnera 5 bott. c/pied. Ø cm. 40 Ø 15 3/4"
 Giant Champagne bucket 5 bot. H cm. 38,5 H 15 1/6"
 Seau à champagne p/5 bout. lt. 15 gal. 4
 Champagner Bowl 5 Fläsche
 Cubo de champagne p/5 bot.

685



mm. 1,2 Champagnera 5 bott. s/pied. Ø cm. 40 Ø 15 3/4"
 Giant Champagne bucket 5 bot. H cm. 21,8 H 8 3/5"
 Seau à champagne p/5 bout. lt. 15 gal. 4
 Champagner Bowl 5 Fläsche
 Cubo de champagne p/5 bot.

666I



mm. 1,2 Colonna portabottiglie spumante H cm. 78 H 30 5/7"
 Wine cooler stand
 Pied pour seau à champagne
 Weinkühlerständer
 Columna porta cubo champany

674



mm. 1,2 Spumantiera termica 5 bott. s/pied. Ø cm. 40 Ø 15 3/4"
 Giant insulated Champagne bucket 5b. H cm. 21,8 H 8 3/5"
 Seau à champagne thermique p/5 bou. lt. 15 gal. 4
 Isolier Champagner Bowl 5 Fläsche
 Cubo térmico para champagne p/5 bot.

265

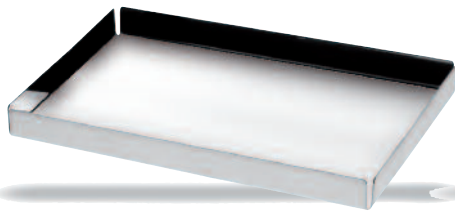

NEW

207



mm. 1,2 Vassoio per pasticceria
Patisserie tray
Plateau pour patisserie
Patisserie Tablett
Bandeja para pasteleria

cm. 24,5 x 17 9 5/8" x 6 3/4"
cm. 30 x 21 11 3/4" x 8 1/4"
cm. 34 x 24 13 3/8" x 9 1/2"

con piedistallo
with foot
avec socle
mit Fuss
con pies

cm. 24,5 x 17 9 5/8" x 6 3/4"
cm. 30 x 21 11 3/4" x 8 1/4"
cm. 34 x 24 13 3/8" x 9 1/2"
H cm. 13 H 5 1/9"

516



516



51610



518

mm. 1,2 Portabustine da zucchero
Sugar packet holder
Pot à sucre
Zuckerstangengefäß
Azucarera

516
cm. 10 x 7
H cm. 3

516
4" x 2 3/4"
H 1 1/8"

51610
cm. 10 x 5
H cm. 4,5

51610
4" x 2"
H 1 3/4"

Cesto portapane, porta agrumi
Basket for bread/ for fruit
Panier / Porte agrumes
Brot-/Früchtekorb
Cesto por pan/ por cítricos
mm. 1,2

cm. 33 x 26
H cm. 20

13" x 10 1/5"
H 7 7/8"

704

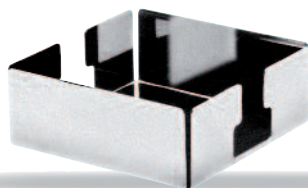

Portatovaglioli
Napkin holder
Distributeur de serviettes
Serviettenhalter
Portaservilletas
mm. 1,2

cm. 13 x 13

5 1/9" x 5 1/9"

270



Portatovaglioli
Napkin holder
Distributeur de serviettes
Serviettenhalter
Portaservilletas
mm. 1,2

cm. 12,5 x 4,5
H cm. 7

5" x 1 7/8"
H 2 3/4"

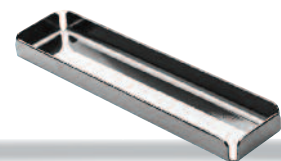

Portastuzzicadenti
Toothpick container
Porte-cure-dents
Zahnstocherbehälter
Porta-palillos
mm. 1,2

cm. 11 x 3

4 1/3" x 1 1/5"

424

206

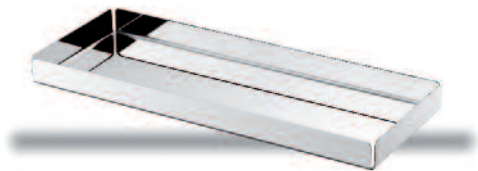

mm. 1,2 Vassoio per pasticceria cm. 26 x 12 10¹/₄" x 4³/₄"
 Patisserie tray cm. 60 x 12 23³/₅" x 10¹/₅"
 Plateau pour patisserie
 Patisserie Tablett
 Bandeja para pasteleria

205



con piedistallo cm. 26 x 12
 with foot cm. 60 x 12
 avec socle H cm. 13
 mit Fuss
 con pies 10¹/₄" x 4³/₄"
 23³/₅" x 10¹/₅"
 H 5¹/₉"

153

NEW

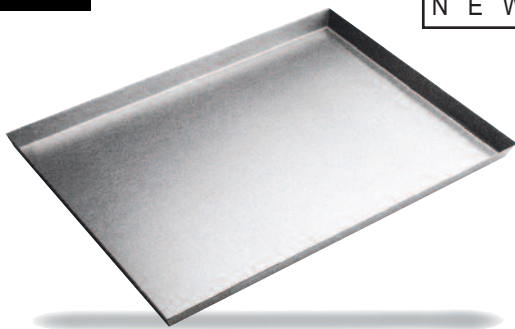

mm. 1,2 Vassoio portabicchieri impilabile cm. 38 x 27
 Stackable tray for glasses
 Plateau porte verres empilable
 Stapelbare Gläserträger Tablett 15" x 10⁵/₈"
 Bandeja porta vasos impilable

505

NEW



mm. 1,2 Vassoio per carrelli cm. 56 x 40 16" x 22"
 Tray for rack trolley
 Plateau pour chariot porte-plateau
 Tablett für Rack
 Bandeja para estante

150



mm. 1,2 Platto concavo Ø cm. 14 Ø 5¹/₂"
 Crescent plate Ø cm. 18 Ø 7"
 Plateau concave Ø cm. 20 Ø 7⁷/₈"
 Konkave Platte Ø cm. 22 Ø 8⁵/₈"
 Plato concavo Ø cm. 24 Ø 9¹/₂"
 Ø cm. 26 Ø 10¹/₄"
 Ø cm. 28 Ø 11"

154

NEW



mm. 1,2 Cestino per pane Ø cm. 20 Ø 7⁷/₈"
 Bread basket Lt. 2 oz. 67³/₅
 Corbeille pour pan
 Brotschale
 Cuenco para pan

284



mm. 1,2	Vassoio rettangolare da servizio	cm. 30x21	11 ³ / ₄ " x 8 ¹ / ₄ "
	Rectangular service tray	cm. 35x24	13 ³ / ₄ " x 9 ¹ / ₂ "
	Plateau rectangulaire pour service	cm. 40x27	15 ³ / ₄ " x 10 ⁵ / ₈ "
	Tablett rechteckig für Service	cm. 45x31	17 ³ / ₄ " x 12 ¹ / ₄ "
	Bandeja rectangular da servicio	cm. 50x34	19 ⁵ / ₈ " x 13 ³ / ₈ "
		cm. 60x42	23 ⁵ / ₈ " x 16 ¹ / ₈ "

283



mm. 1,2	Vassoio tondo da servizio	Ø cm. 27	Ø 10 ⁵ / ₈ "
	Round service tray	Ø cm. 35	Ø 13 ³ / ₄ "
	Plateau rond pour service	Ø cm. 40	Ø 15 ³ / ₄ "
	Tablett rund für Service		
	Bandeja redonda por servicio		

415



mm. 1,2	Cloche per servizio, mantieni calore	Ø cm. 20
	Cloche for service, heat keeper	
	Cloche pour service, mainteneur de chaleur	
	Service-Cloche, Wärmepflege	Ø 7 ⁷ / ₈ "
	Cloche de servicio, mantenedor de calor.	



225



Cloche trasparente con pomolo	Ø cm. 12	Ø 4 ³ / ₄ "
Transparent cloche with knob	Ø cm. 22	Ø 8 ⁵ / ₈ "
Cloche transparente	Ø cm. 28	Ø 11"
Transparente Teller cloche		
Tapa transparente		

155

NEW



mm. 1,2	Porta noccioli	Ø cm. 6	Ø 2 ² / ₅ "
	Kernel holder	H cm. 5	H 2"
	Porte noyaux	cl. 5	oz. 1 ³ / ₄
	Aderhalter		
	Porta granos		

721



mm. 1,2
Coppa termica gelato e macedonia
Insulated ice cream cup/salad fruit bowl
Coupe thermique a glaçe et macedonie
Isolier-Eisfruchtbecher mit Deckel
Copa térmica helado y macedonia

Ø cm. 8,5 Ø 3 1/3"
cl. 15 oz. 6

259



mm. 1,2
Ciotola con base
Bowl with base
Bol avec socle
Obstschale auf Fuss
Cuenco con pedestal

Ø cm. 20
H cm. 14,3
lt. 2,1

Ø 5 2/3"
H 7 7/8"
gal. 1/2

Ø cm. 28
H cm. 18,3
lt. 5,7

Ø 11"
H 7 1/5"
gal. 1 1/2

864



GALA
Cestino semitraforato
Half fretworked basket
Corbeille demi-ajouré
Schale, halbgelocht
Frutero semiperforado

Ø cm. 22 Ø 8 5/8"
H cm. 5,7 H 2 1/4"
cl. 150 oz. 50 3/4

mm. 0,8

834



GALA
Cestino portafrutta
Round basket
Corbeille ronde
Schale, rund
Frutero redondo

Ø cm. 22 Ø 8 5/8"
H cm. 5,7 H 2 1/4"
cl. 150 oz. 50 3/4

mm. 0,8

Ø cm. 34 Ø 13 3/8"
H cm. 5,7 H 2 1/4"
cl. 500 gal. 1 1/3



GALA
Cestino traforato
Fretworked basket
Corbeille ajouré
Schale, gelocht
Frutero perforado

Ø cm. 22 Ø 8 5/8"
H cm. 5,7 H 2 1/4"
cl. 150 oz. 50 3/4

mm. 0,8

863

254



Supporto per informazioni o menu
Menu / Card holder
Porte nom numéro de table
Karten / Speisekartenhalter
Porta informaciones o menu

Ø cm. 6 Ø 2 1/2"
H cm. 9 H 3 1/2"

Portamenù
Menù holder
Porte-menu
Menükartenhalter
Portamenù



907

cm. 21 x 13,5 8 5/8" x 5 3/8"
H cm 29,7 H 11 3/4"



Portanumero
Table number stand
Numbers etched to order
Porte numéro de table
Tischnummernständer
Porta numero de mesa

A
Ø cm 8,3
H cm 47,3

B
Ø cm 8,3
H cm 24

A
Ø 3 1/4"
H 18 5/8"

B
Ø 3 1/4"
H 9 1/2"

994

712



mm. 1,2 Chillcup per burro e caviale con base
Chillcup for butter and caviar with base
Chillcup pour beurre et caviar avec socle
Chillcup für Butter und Kaviar mit Fuß
Chillcup para mantequilla y caviar con pedestal

713



Chillcup per burro
Chillcup for butter
Chillcup pour beurre
Chillcup für Butter
Chillcup para mantequilla

Ø cm. 12
cl. 15
Ø 4 3/4"
oz. 5 1/8



Servizio per caviale
Caviar set
Service à caviar complet
Kaviarschale
Servicio para caviar

Ø cm. 18
cl. 15
Ø 7 1/8"
oz. 5 1/8

301



301A

301C

301B

mm. 0,8 Chillcup per cocktail di gamberetti Supreme bowl, complete Coupe à crevettes Chillcup für Hummercocktail Chillcup para coctél mariscos	301 Ø cm. 15	Ø 5 7/8"
	cl. 17,5	oz. 6
	301A Ø cm. 15	301A Ø 5 7/8"
	301B Ø cm. 13,5	301B Ø 5 3/8"
	301C Ø cm. 9,5	301C Ø 3 3/4"
	cl. 17,5	oz. 6

725

723

722



mm. 0,6 Piatino per coppa gelato Under liner for ice-cream bowl Petit plat soucoupe glace Unterteller für Eisschale Platillo melado	Ø cm. 12	Ø 4 3/4"

Coppa per gelato e macedonia Ice-cream and salad fruit bowl with stand Coupe à glace et macédoine Eisfrüchteschale Copa helado y macedonia	Ø cm. 8,5	cl. 15
	Ø 3 3/4"	oz. 5 1/8

mm. 1,2 Coppa per gelato Ice-cream bowl Coupe à glace Eisschale Copa helado	Ø cm. 9,5	cl. 17
	Ø 3 3/4"	oz. 6

498



mm. 1,2 Completo oliera con spargisale a 5 H cm. 22 H 8 5/8"
Cruet and salt cellar set 5 pcs. cl. 22,5 (x 2) oz. 7 1/2 (x 2)
Service huile-vinaigre 5 pcs. cl. 7,5 (x 3) oz. 2 1/2 (x 3)
Essig-/Ölgestell 5-Tlg.
Convoy vinagreras con saleros 5 pzs

507



mm. 1,2 Completo oliera con spargisale a 4 H cm. 22 H 8 5/8"
Cruet and salt cellar set 4 pcs. cl. 22,5 (x 2) oz. 7 1/2 (x 2)
Service huile-vinaigre 4 pcs. cl. 7,5 (x 2) oz. 2 1/2 (x 2)
Essig-/Ölgestell 4-Tlg.
Convoy vinagreras con saleros 4 pzs

506



430350

mm. 1,2 Oliera GALA H cm. 22 H 8 5/8"
Cruet » cl. 22,5 (x 2) oz. 7 1/2 (x 2)
2 pièces huile-vinaigre »
Essig-/Ölgestell »
Vinagreras »

525



mm. 1,2 Formaggera GALA cl. 20 oz. 6 3/4
Parmesan cheese basin »
Fromagère »
Käsedose »
Quesera-Azucarero »

513



430510SS 430510ST

mm. 1,2 Spargisale, portastecchi GALA H cm. 15
Salt-cellar with toothpick container » cl. 7,5 (x 3)
Sel-poivre/porte cure-dents »
Salz-Pfeffer-Zahnstocherbehälter » H 5 7/8"
Saleros y pimentero y palillero » oz. 2 1/2 (x 3)

702



mm. 1,2 Mini burriera con coperchio cm. 12 x 6 4 3/4" x 2 1/3"
Small butter dish w/lid cl. 15 oz. 5 1/8
Petit beurrier a/couvercle
Mini Butterdose m/Deckel
Platillo para mantequilla con tapa



Dry Aged

DRY AGED



620

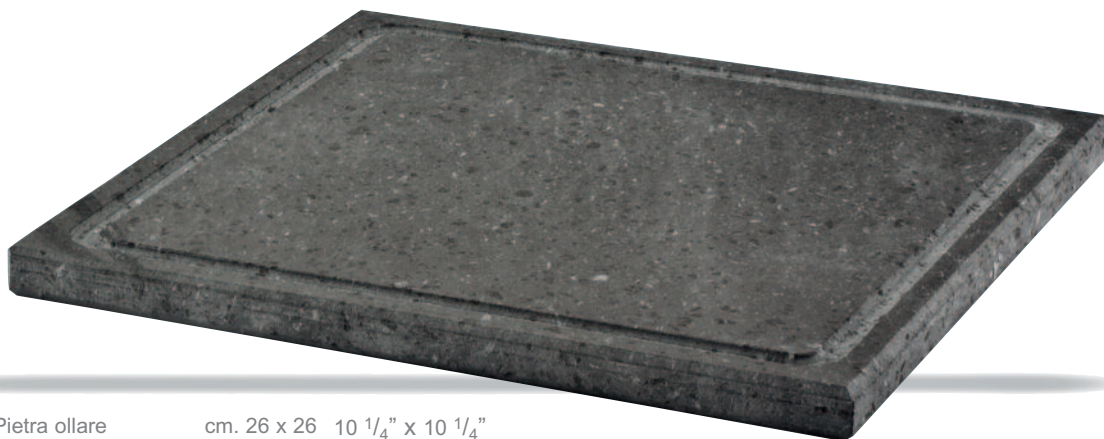

Pietra ollare
Soapstone
Ardoise
Speckstein
Pizarra

cm. 26 x 26 10 1/4" x 10 1/4"

700



H cm 10 H 4"
cl. 35 oz. 11 7/8

mm. 1,2 Portapatatine fritte
French fry holder for table
Porte pommes frites pour table
Kartoffelbehälter für Tisch
Porta patatas fritas por mesa

260



Ø cm 10 H 3 3/4"
H cm 9,5 Ø 3 7/8"

289



H cm. 10 H 3 7/8"
Ø cm. 6 Ø 2"

902



H cm 8 H 3 1/4"
Ø cm 7 Ø 2 3/4"

282



mm. 1,2 Braciere con pietre naturali Ø cm. 15 Ø 5 7/8"
Table grill with natural stones Ø cm. 22 Ø 8 5/8"
Brasero avec pierres naturelles Ø cm. 32 Ø 12 5/8"
Feuerschale mit Natursteine
Hoguera c/piedras naturales

572



Ampolla cl. 20 oz. 6 3/4
Cruet cl. 34 oz. 11 1/2
Huilliere cl. 62 oz. 21
Öl-/Essigflaschen
mit Spender
Vinagrera

1136

1136

10001136



10001136

UNI

Coltello bistecca cm. 21,3 8 1/4"

Steak knife

Couteau entrecôte

Steakmesser

Cuchillo bistek

10101136

10231136



10101136

NORMA

10231136

BOHEME

Coltello bistecca cm. 23 9 1/8"

Steak knife

Couteau entrecôte

Steakmesser

Cuchillo bistek

10141136

1020B1136

10341136



10141136

ROMA

1020B1136

BRESCIA

10341136

NATURA

Coltello bistecca cm. 22,7 8 7/8"

Steak knife

Couteau entrecôte

Steakmesser

Cuchillo bistek

1144

1144

10001144



Coltello bistecca americano

cm. 25 9 5/8"

American steak knife

Couteau entrecôte américain

Amerikanisches Steakmesser

Cuchillo bistek americano

28215



mm. 1,2 Braciare con pietre naturali
Table grill with natural stones
Brasero avec pierres naturelles
Feuerschale mit Natursteine
Hoguera c/piedras naturales

Ø cm. 15 Ø 5 7/8"

28222



mm. 1,2 Braciare con pietre naturali
Table grill with natural stones
Brasero avec pierres naturelles
Feuerschale mit Natursteine
Hoguera c/piedras naturales

Ø cm. 22 Ø 8 5/8"

28232



mm. 1,2 Braciare con pietre naturali
Table grill with natural stones
Brasero avec pierres naturelles
Feuerschale mit Natursteine
Hoguera c/piedras naturales

Ø cm. 32 Ø 12 5/8"



A differenza del carbone, le pietre laviche rilasciano il calore molto lentamente e possono mantenere il cibo in cottura, senza cuocerlo eccessivamente

Unlike charcoal, lava stones release the heat very slowly and can cook food without over-cooking.

NEW

DRY AGED

NEW

78125



mm. 1,2 Sauteuse

cm. 25 9 5/8"

78130



mm. 1,2 Sauteuse

cm. 30 11 3/4"

78135



mm. 1,2 Sauteuse

cm. 35 13 3/4"

78140



mm. 1,2 Sauteuse

cm. 40 15 3/4"



574



Antipastiera quadra in vetro cm. 24,5 x 24,5 9⁵/₈" x 9⁵/₈"
 Hors d'oeuvre tray in glass
 Plat à hors d'oeuvre en verre
 Vorspeisenplatte aus Glas
 Entremesera en vidrio

575



Piatto quadro in vetro cm. 24,5 x 24,5 9⁵/₈" x 9⁵/₈"
 Square plate in glass
 Plateau carré en verre
 Platte, viereckig, aus Glas
 Plato cuadrado en vidrio

582



Supporto per cm. 43 x 14 16⁷/₈" x 5¹/₂"
 Multifunction stand for
 Support multi-usages pour
 Schalenhalter
 Soporte multiuso para

581



Supporto per cm. 36 x 14 14¹/₈" x 5¹/₂"
 Multifunction stand for
 Support multi-usages pour
 Schalenhalter
 Soporte multiuso para

570



mm. 1,2 UNO
 Cremiera
 Cream jug
 Crémier
 Sahnegießer
 Jarrita lechera
 Ø cm. 6 Ø 2 ³/₈"
 H cm. 8,8 H 3 ¹/₂"
 cl. 16 oz 5 ³/₈

594



mm. 1,2 UNO
 Cremiera con piedistallo
 Cream jug with base
 Crémier avec socle
 Sahnegießer auf Fuss
 Jarrita lechera con pedestal
 Ø cm. 6 Ø 2 ³/₈"
 H cm. 9 H 3 ¹/₂"
 cl. 16 oz 5 ³/₈

576



Servizio per pinzimonio in vetro Ø cm. 28 Ø 11"
 Salad set in glas H cm. 8 H 3 1/8"
 Service pour salade en verre cl. 300 oz. 101 1/2
 Service für Salat aus Glas
 Servicio para ensalada en vidrio

290576



Servizio per pinzimonio Ø cm. 28 Ø 11"
 Set for salad serving cl. 300 oz. 101 1/2
 Service à crudités
 Set "Salatdressing"
 Servicio para ensaladas

Ciambella termica per supporto Milleusi. La ciambella termica è usata per mantenere a lungo le temperature calde o fredde. Nel primo caso va riscaldata in forno ad una temperatura variabile tra i 160° C ed i 250° C, nel secondo caso va conservata in freezer a -14° C. In queste condizioni e in grado di mantenere la temperatura desiderata (da -5° C a +50° C) per un periodo che varia dai 20 ai 30 minuti

Thermal serving unit for multifunction stand.

The thermal serving unit is used to maintain heat or cold. In the first case, it must be heated in an oven at 160° C (+320° F) -250° C (+482° F). In the second case in a Freezer at -14° C (-57° F). In these conditions it is able to maintain the food either hot or cold for a period between 20 and 30 minutes at the desired temperature (from -5° C (-41° F) to +50° C (+122° F)).

Disque thermique pour support multi-usages. Le disque thermique est utilisé pour maintenir la chaleur ou le froid. Dans un cas, le disque est préchauffé dans le four à une température variant de 160° C a 250° C. Dans un second cas, le disque peut être refroidi jusqu'à -14° C. Dans ces conditions, le disque est en mesure de maintenir la chaleur ou la fraîcheur pendant un temp variable de 20 a 30 minutes, a la température voulue (de -5° C a +50° C).



583
 Ciambella termica per supporti
 Thermal serving unit for stands
 Disque thermique pour support
 Thermische Ringröhre für Hälter
 Bobina térmica para soportes
 Ø cm. 12 - Ø 4 3/4"

Der Warmhalteteller mit Thermikelement dient zum Servieren von warm- oder kalzuhaltenden Speisen, also sowohl zur Speicherung von Wärme als auch von Kälte. Zum Warmhalten erhitzt man das runde Thermikelement im Ofen auf 160 bis 250° C. Zum Kalthalten kühlt man im Gefrierfach das runde Thermikelement auf -14° C ab. Derart eingefügt in die Vertiefung des Warmhaltetellers kann man Speisen bis zu 30 min bei einer gewünschten Temperatur zwischen -5° C und +50° C kalt bzw. warm halten.

Bobina térmica para soporte multiuso. La bobina térmica puede ser utilizada para mantener el calor o el frío. En el primer caso, se calienta en el horno a una temperatura variable entre 160° C y 250° C; en el segundo, se mete en un congelador a -14° C. En estas condiciones, es capaz de mantener los alimentos calientes o fríos durante un periodo que oscila entre 20 y 30 minutos a la temperatura deseada (de -5° C a +50° C).



582

580



Pirofila ovale in fine china cm. 37 x 24 14 5/8" x 9 3/8"
 Fine china oval bowl cl. 300 oz. 101 1/2
 Plat oval en porcelaine à feu
 Auflaufform, oval aus Porzellan
 Pirophila oval en porcelana

579



Lasagnera in fine china cm. 34,5 x 24,5 13 5/8" x 9 5/8"
 Fine china Lasagne's bowl cl. 300 oz. 101 1/2
 Plat rectangulaire en porcelaine à feu
 Auflaufform, quadr. aus Porzellan
 Fuente para Lasagne en porcelana



Room Service

272



mm. 0,8
 Piatto termico con copripiatto e ciambella termica
 Insulated plate with cover and thermal serving unit
 Plat thermique avec couvre-plat et disque thermique
 Warmhalteteller mit Tellerglocke und Thermikelement
 Plato térmico con cubre platos y bobina térmica

Ø cm. 28,5
 Ø cm. 30,5
 Ø cm. 33,7

Ø 11¹/₄"
 Ø 12"
 Ø 13¹/₄"

273



mm. 0,8
 Piatto termico con cloche e ciambella termica
 Insulated plate with cloche and thermal serving unit
 Plat thermique avec cloche et disque thermique
 Warmhalteteller mit Tellerglocke und Thermikelement
 Plato térmico con tapadera y bobina térmica

Ø cm. 28,5
 Ø cm. 30,5
 Ø cm. 33,7

Ø 11¹/₄"
 Ø 12"
 Ø 13¹/₄"

A Ø cm. 28 - 30 - 33
 Ø 11" - 11³/₄" - 13¹/₄"

B Ø cm. 28 - 30 - 33
 Ø 11" - 11³/₄" - 13¹/₄"



C Ø cm. 12
 Ø 4³/₄"

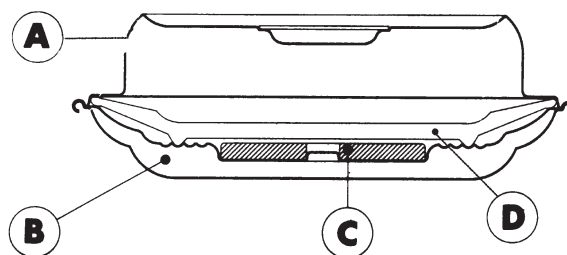

La ciambella termica © è usata per mantenere a lungo le temperature calde o fredde.

Nel primo caso va riscaldata in forno ad una temperatura variabile tra i 60°C ed i 150°C; nel secondo caso in Freezer a -14°C. In queste condizioni è in grado di mantenere la temperatura desiderata (da -5°C a +50°C) per un periodo che varia dai 20 ai 30 minuti.

The Thermal serving unit © maintains food at hot or cold temperatures for about 30 minutes.

The disk can be placed in an oven at 140°C (302°F) or in a freezer at -14°C (-57°F).

Le disque thermique © est utilisé pour maintenir la chaleur ou le froid. Dans un cas, le disque est préchauffé dans le four à une température variant de 60°C à 150°C. Dans un second cas, le disque peut être refroidi jusqu'à -14°C. Dans ces conditions, le disque est en mesure de maintenir la chaleur ou la fraîcheur pendant un temps variable de 20 à 30 minutes, à la température voulue (de -5°C à -50°C).

Der Warmhalteteller mit Thermikelement dient zum Servieren von warm- oder kalzuhaltenden Speisen, also sowohl zur Speicherung von Wärme als auch von Kälte. Zum Warmhalten erhitzt man das runde Thermikelement im Ofen auf 60° bis 150° C. Zum Kalthalten kühlt man im Gefrierfach das runde Thermikelement auf -14° C ab. Derart eingefügt in die Vertiefung des Warmhaltetellers kann man Speisen bis zu 30 min bei einer gewünschten Temperatur zwischen -5° C und +50° C kalt bzw. warm halten.

La bobina térmica © puede ser utilizada para mantener el calor o el frío. En el primer caso se calienta en el horno a una temperatura variable entre 60°C y 150°C; en el segundo, se mete en un congelador a -14°C. En estas condiciones es capaz de mantener los alimentos calientes o fríos durante un periodo que oscila entre 20 y 30 minutos a la temperatura deseada (de -5° C a +50° C).

Una rivoluzionaria soluzione per un servizio ai piani di alta classe, nella massima sicurezza anti-incendio, evitando l'uso di fiamme o fornelli.

A revolutionary solution for room service, eliminating the need of fuel or electric wires.

C'est une solution révolutionnaire pour un Service à l'Étage de qualité en conformité avec les règles de sûreté anti-incendie et en évitant l'usage de flammes ou feux ouverts.

Dies ist eine revolutionäre Lösung für den hohen Anspruch an excellenten Zimmerservice. Man vermeidet dabei den Gebrauch von offenem Feuer oder elektrischen Platten und vermeidet Konflikte mit den Brandschutzrichtlinien der jeweiligen Länder

Es una solución revolucionaria para un servicio de habitación de alta calidad que respeta las normas de seguridad contra incendios, pues evita el peligro de l'uso de llamas y hornillos encendidos.

425
Tiffin' box

H cm. 21,3
cm. 24,5 x 25,3

H 8 2/5"
9 5/8" x 10"

Colori personalizzati a disposizione
Custom colors available
Couleurs personnalisées
Benutzerdefinierte Farben verfügbar
Colores personalizados disponible



NEW

ROOM SERVICE

NEW

425



153



153

mm. 1,2 Vassoio per carrelli cm. 56 x 40 22" x 16"
 Tray for rack trolley
 Plateau pour chariot porte-plateau
 Tablett für Rack
 Bandeja para estante

429

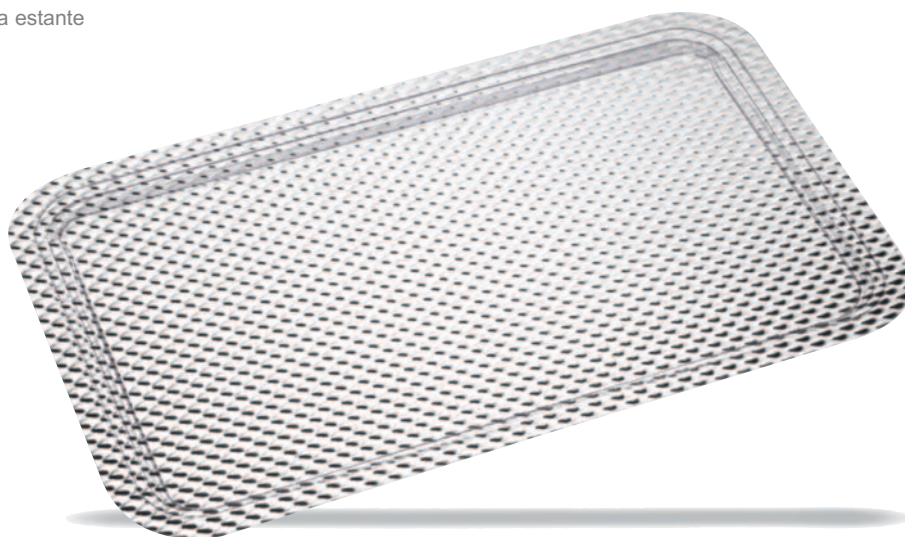

429

mm. 1,0 Vassoio per carrelli cm. 63 x 45 24 11/16" x 17 3/4"
 Tray for rack trolley
 Plateau pour chariot porte-plateau
 Tablett für Rack
 Bandeja para estante

429

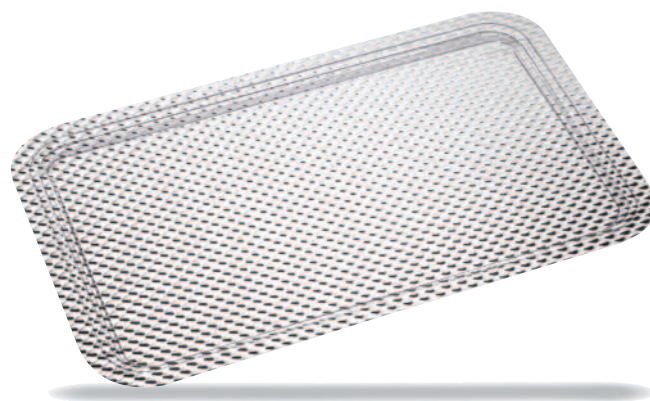

429

mm. 1,0 Vassoio per carrelli cm. 45 x 31 17 3/4" x 12 1/4"
 Tray for rack trolley
 Plateau pour chariot porte-plateau
 Tablett für Rack
 Bandeja para estante





Menu & Banquet

305

316



mm. 1,2 Vassoio rettangolare
Rectangular tray
Plateau rectangulaire
Tablett, rechteckig
Bandeja rectangular
cm. 40,5 x 27,5 15⁷/₈" x 10³/₄"
cm. 45 x 31 17³/₄" x 12¹/₄"

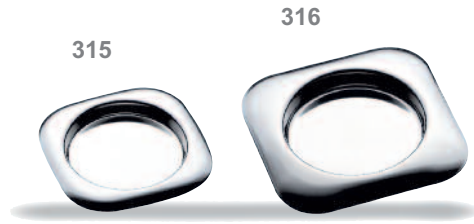

315 316
mm. 1,2 Sottobicchiere e sottobottiglia
Glass and bottle coaster
Dessous de verre et de bouteille
Glasuntersatz - Flaschenteller
Posavaso y Posabotella
cm. 10 x 10 4" x 4"
cm. 12,5 x 12,5 5" x 5"

323

313



mm. 1,2 Sottopiatto quadrato
Square charger
Assiette de bienvenue carré
Platzteller, viereckig
Bajo plato cuadrado
cm. 32 x 32 12¹/₂" x 12¹/₂"



mm. 0,8 Sottopiatto
Charger
Assiette de bienvenue
Platzteller
Bajo plato
Ø cm. 31 Ø 12 1/4"

319

320



mm. 1,2 Vassoio quadrato
Square plate
Plateau carré
Tablett, viereckig
Bandeja cuadrada
cm. 32 x 32 12¹/₂" x 12¹/₂"



mm. 1,2 Vassoio "Tête à tête"
"Tête à tête" tray
Plateau "Tête à tête"
Tablett "Tête à tête"
Bandeja "Tête à tête"
Ø cm. 22 Ø 8 5/8"

312



mm. 1,2 Antipastiera 4 scomparti in cristallo cm. 40,5 x 27,5 15⁷/₈" x 10³/₄"
 Hors-d'oeuvre tray 4 compt.
 Plat à hors-d'oeuvre 4 comp. cristal
 Vorspeisenplatte 4 Einsatze
 Entremesera

325

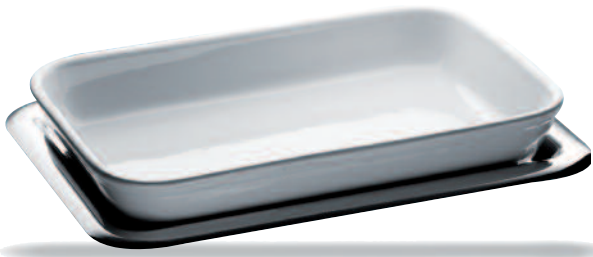

mm. 1,2 Lasagnera rettangolare cm. 40,5 x 27,5 15⁷/₈" x 10³/₄"
 Set for Lasagne lt. 3 oz. 102 1/9
 Service pour Lasagne
 Set mit Porzellanschale, rech.
 Servicio para Lasagne

324



mm. 1,2 Risottiera tonda Ø cm. 31 Ø 12 1/4"
 Set for risotti lt. 2 oz. 67 3/5
 Service pour risotto
 Set mit Porzellanschale, rund
 Servicio para arroces

309



mm. 1,2 Portatovaglioli cm. 22 x 22 8⁵/₈" x 8⁵/₈"
 Napkin holder
 Distributeur de serviettes
 Serviettenhalter
 Portaservilletas

31802



mm. 1,2 Portaspezie cm. 15 x 15 5 7/8" x 5 7/8"
 Aromatic condiments set H cm. 25,5 H 10"
 Service pour aromatiques cl. 11 (x 8) oz. 3 3/4 (x 8)
 condiments
 Gewürzständer
 Servicio para aromaticos y
 condimentos

308



mm. 1,2
Cestino per pane
Basket
Corbeille
Brotschale
Cuenco

cm. 22 x 22 8⁵/₈" x 8⁵/₈" mm. 1,2
cl. 80 oz. 27

mm. 1,2
Allacciatovaglioli
Napkins ring
Rond de serviette
Serviettenring
Servilletero

Ø cm. 6 Ø 2 3/8"

317

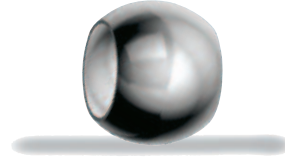

306



mm. 1,2
Completo oliera con spargisale
Cruet and salt cellar set 4 pcs.
Service huile-vinaigre 4 pcs.
Essig-/Ölgestell 4-Tlg.
Convoy vinagreras con saleros

H cm. 19 H 7³/₈"
cl. 18 (x2) oz. 6 (x2)
cl. 11 (x2) oz. 3³/₄ (x2)

mm. 1,2
Formaggera
Parmesan cheese basin
Fromagère
Kasedose
Quesera-Azucarero

cl. 20 oz. 6 3/4

307



310



mm. 1,2
Portabicchieri di carta
Paper cup holder
Porte-gobelets de papier
Papierbecherständer
Portavasos de papel

cm. 21 x 11 8³/₁₆" x 4¹/₄"
H cm. 22,8 H 8 7/8"

mm. 1,2
Portapiatti di plastica
Plastic paper plate dispenser
Porte-plateau de plastique
Stand für Plastik Platten
Portaplatos de plastica

Ø cm. 22 Ø 8 5/8"

321



164



mm. 1,2 Vassoio rettangolare
Rectangular tray
Plateau rectangulaire
Tablett, rechteckig
Bandeja rectangular

cm. 40 x 29 15³/₄" x 11³/₈"
cm. 49 x 36 19¹/₄" x 14¹/₈"

165



mm. 1,2 Vassoio rotondo
Round tray
Plateau ronde
Tablett, rund
Bandeja redonda

Ø cm. 35 Ø 13 ³/₄"

168



mm. 1,2 Completo olieria con spargisale
Cruet and salt cellar set 4 pcs
Service huile-vinaigre 4 pièces
Essig-/Ölgestell 4-Tlg.
Convoy vinagreras con saleros
4 piezas

H cm. 20 H 7⁷/₈"
cl. 18 (x 2) oz. 6 (x 2)
cl. 11 (x 2) oz. 3³/₄ (x 2)

169



mm. 1,2 Formaggera
Parmesan cheese basin
Fromagère
Kasedose
Quesera-Azucarero

cl. 20 oz. 6 ³/₄



408

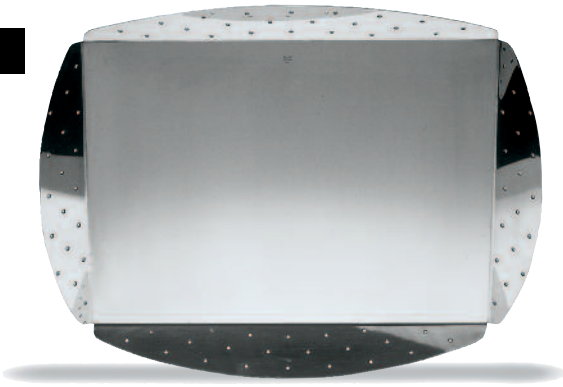

mm. 1,2 TALAMO
 Vassoio rettangolare
 Rectangular tray
 Plateau rectangulaire
 Tablett, rechteckig
 Bandeja rectangular

cm. 29 x 23 11³/₈" x 9"
 cm. 47 x 37 18¹/₂" x 14¹/₂"

409



mm. 1,2 TALAMINO
 Vassoio quadrato
 Square tray
 Plateau carré
 Tablett, viereckig
 Bandeja cuadrada

cm. 37 x 37 14¹/₂" x 14¹/₂"

406

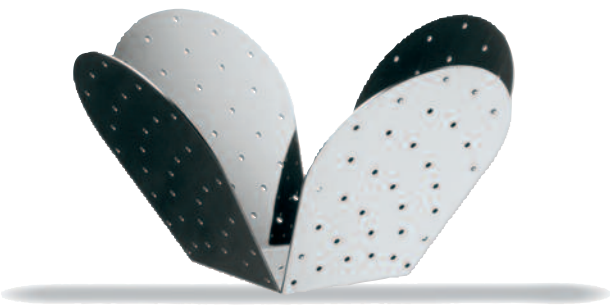

mm. 1,2 BOCCIOLO
 Cestino
 Basket
 Corbeille
 Obstschale
 Frutero

Ø cm. 24,5 Ø 9²/₃"
 H cm. 13,5 H 5¹/₃"
 lt. 4 gal. 1

407

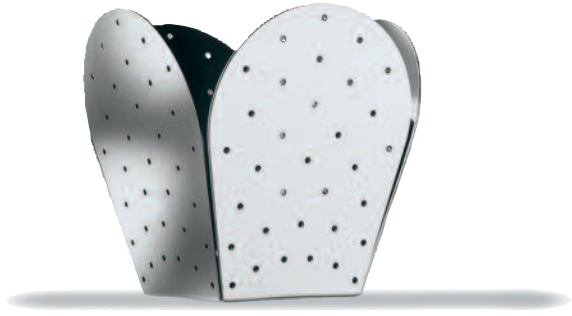

mm. 1,2 BOCCIOLINO
 Cestino
 Basket
 Corbeille
 Obstschale
 Frutero

Ø cm. 16,5 Ø 6¹/₂"
 H cm. 15,5 H 6¹/₉"
 lt. 2,64 oz. 89¹/₄

410



mm. 1,2 COROLLA
 Completo oliera con spargisale
 Cruet and salt cellar set
 Service huile-vinaigre
 Essig-/Ölgestell 4-Tlg.
 Convoy vinagreras con saleros
 H cm. 20- cl.18(x2) cl.11(x2)
 H 7⁷/₈" - oz.6(x2) oz.3³/₄ (x2)

PISTILLA
 Formaggera
 Parmesan cheese basin
 Fromagère
 Käsedose
 Quesera-Azucarero
 cl. 20
 oz. 6³/₄

505



mm. 1,2 COROLLA
 Cestello portacondimenti
 Basket for aromatic condiments
 Corbeille pour aromatiques condiments
 Essig-und Öl Flaschenhalter
 Cesto para aromaticos y condimentos

H cm. 20
 cl.25(x2)
 cl.11(x2)

H 7⁷/₈"
 oz.8¹/₂(x2)
 oz.3³/₄(x2)

331



mm. 1,2 Sottopiatto
Charger
Assiette de bienvenue
Platzteller
Bajo plato
Ø cm. 33 Ø 13"

333

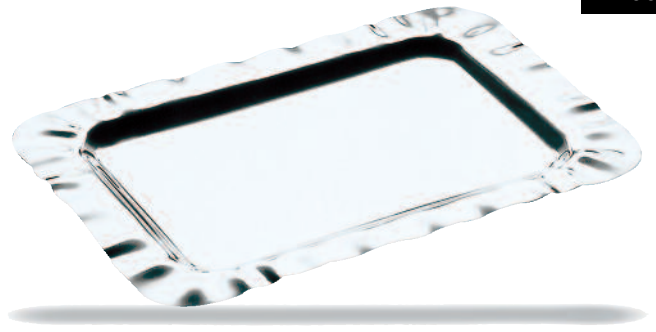

mm. 1,2 Vassoio rettangolare
Rectangular tray
Plateau rectangulaire
Tablett, rechteckig
Bandeja rectangular
cm. 50 x 34 19⁵/₈" x 13³/₈"

332



mm. 1,2 Vassoio ovale
Oval tray
Plateau oval
Tablett, oval
Bandeja oval
cm. 49 x 33 19¹/₄" x 13"

337



mm. 1,2 Cestino tondo
Round basket
Corbeille ronde
Obstschale, rund
Frutero redondo
Ø cm. 31 Ø 12¹/₄"
cl. 125 oz. 42 ¹/₄

335



mm. 1,2 Completo oliera con spargisale
Cruet and salt cellar set
Service huile-vinaigre
Essig-/Ölgestell 4-Tlg.
Convoy vinagreras con saleros
H cm. 21
cl.22,5(x2)
cl.7,5(x2)
H 8¹/₄"
oz.7¹/₂(x2)
oz.2¹/₂(x2)

336



mm. 1,2 Formaggera
Parmesan cheese basin
Fromagère
Käsedose
Quesera-Azucarero
cl. 20 oz. 6³/₄

201

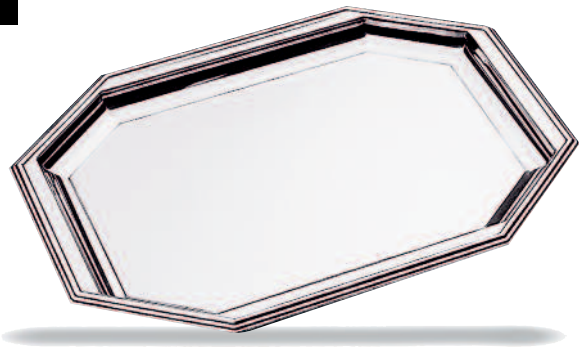

mm. 1,2 Vassoio
Tray
Plateau
Tablett
Bandeja
cm. 30 x 24 11³/₄" x 9¹/₂"
cm. 40 x 31 15³/₄" x 12¹/₄"
cm. 50 x 39 19⁵/₈" x 15³/₈"

202



mm. 1,2 Vassoio con maniglie
Tray with handles
Plateau avec anses
Tablett mit Griffen
Bandeja con asas
cm. 40 x 31 15³/₄" x 12¹/₄"
cm. 50 x 39 19⁵/₈" x 15³/₈"

203



mm. 1,2 Vassoio
Tray
Plateau
Tablett
Bandeja
Ø cm. 25 Ø 9 ⁷/₈"
Ø cm. 31 Ø 12 ¹/₄"

199

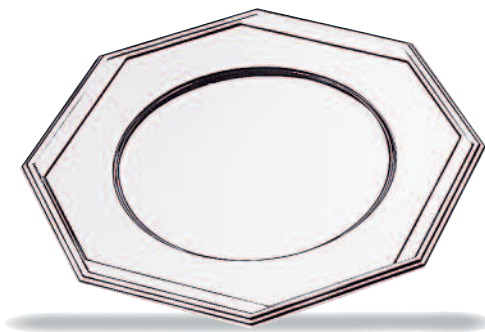

mm. 1,2 Sottopiatto
Charger
Assiette de bienvenue
Platzteller
Bajo plato
Ø cm. 31 Ø 12¹/₄"

716



mm. 0,8 Piattino per burro con coperchio e griglia
Butter dish with inserted grill and cover
Beurrer avec grill et couvercle
Butterkühler mit Einsatzsieb und Deckel
Plato para mantequilla con rejilla y tapa
Ø cm. 9 cl. 25 Ø 3¹/₂"
oz 8 ¹/₂

210

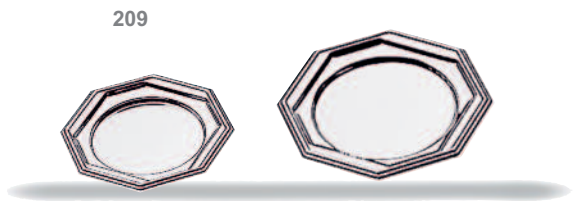

mm. 0,8 Sottobicchiere e sottobottiglia
Glass and bottle coaster
Dessous de verre et de bouteille
Glasuntersatz - Flaschenteller
Posavaso y Posabotella
209
Ø cm. 10,5 Ø 4¹/₈"
Ø cm. 12,5 Ø 4⁷/₈"

502



mm. 0,8 Completo oliera con spargisale
Cruet and salt cellar set
Service huile-vinaigre 4 pièces
Essig-/Ölgestell 4-Tlg.
Convoy vinagreras con saleros 4 pzs

H cm. 21 H 8 1/4"
cl. 22,5 (x 2) oz. 7 1/2 (x 2)
cl. 7,5 (x 2) oz. 2 1/2 (x 2)

522



mm. 0,8 Formaggera
Parmesan cheese basin
Fromagère
Käsedose
Quesera-Azucarero

cl. 20 oz. 6 3/4

844



mm. 1,2 Cestino rettangolare
Rectangular basket
Corbeille rectangulaire
Obstschale rechteckig
Panera rectangular

cm. 30 x 24 11 3/4" x 9 1/2"
cl. 200 oz. 67 5/8

843



mm. 1,2 Cestino
Round Basket
Corbeille
Obstschale
Frutero

Ø cm. 25 Ø 9 7/8"
cl. 150 oz. 50 3/4

103



mm. 1,2 Sottopiatto Ø cm. 33 Ø 13"
 Charger Ø cm. 35 Ø 13 3/4"
 Assiette de bienvenue
 Platzteller
 Bajo plato

131



mm. 0,8 Sottopiatto RAFFAELLO Ø cm. 32,5 Ø 12 3/4"
 Charger »
 Assiette de bienvenue »
 Platzteller »
 Bajo plato »

294



mm. 1,2 Porta pasticcini con piedistallo Ø cm. 19 Ø 7 1/2"
 Petit-fours stand with base H cm. 14,5 H 5 3/4"
 Porte-petits-fours avec socle
 Petit Fours-Ständer Ø cm. 24 Ø 9 1/2"
 Porta dulces con pedestal H cm. 14,5 H 5 3/4"

7003A



mm. 1,2 Alzata portafrutta 2 piani Ø cm. 24 Ø 9 1/2"
 Fruit holder 2 layers Ø cm. 31 Ø 12 1/4"
 Serviteur 2 etages H cm. 24,5 H 9 5/8"
 Etagere 2 stufig
 Frutero 2 pisos

293



mm. 1,2 Porta pasticcini con piedistallo 2 Piani Ø cm. 12 Ø 4 3/4"
 Petit-fours stand with base 2 Layers Ø cm. 19 Ø 7 1/2"
 Porte-petits-fours avec socle 2 Etages H cm. 27 H 10 5/8"
 Mokkaetagere 2 Ebenen
 Porta dulces con pedestal 2 Pisos

7003B



mm. 1,2 Alzata portafrutta 3 piani Ø cm. 19 Ø 7 1/2"
 Fruit holder 3 layers Ø cm. 24 Ø 9 1/2"
 Serviteur 3 etages Ø cm. 31 Ø 12 1/4"
 Etagere 3 stufig H cm. 35,5 H 14"
 Frutero 3 pisos

204



mm. 1,2 Porta macaron
Macarons server
Porte macarons
Macaronsträger
Porta macaron

Ø cm. 15 Ø 5 7/8"
H cm. 11,5 H 4 1/2"
cl. 20 oz. 6 3/4

715



mm.0,8 Piattino per burro con coperchio e griglia
Butter dish with inserted grill and cover
Beurrer avec grille et couvercle
Butterdose mit Einsatzsieb und Deckel
Plato para mantequilla con rejilla y tapa

Ø cm. 9 Ø 3 1/2"
cl. 20 oz. 6 3/4

105



mm. 1,2 Sottobicchiere
Glass coaster
Dessous de verre
Glasuntersatz
Posavasos

Ø cm. 10 Ø 4"

106



mm.1,2 Sottobottiglia
Bottle coaster
Dessous de bouteille
Flaschenteller
Posabotella

Ø cm. 12 Ø 4 3/4"

208



mm. 1,2 Piattino per pane
Bread tray
Plat pour pan
Brot Platte
Plato para pan

Ø cm. 14 Ø 5 1/2"

292



mm. 1,2 Servizio per zucchero con cristallo
Sugar set with crystal
Service à sucre avec cristal
Zuckerständer mit Kristalleinsätzen
Servicio para azúcar con cristales

Ø cm. 33 Ø 13"
cl. 15(x3) oz. 5(x3)

497



mm. 1,2 Completo oliera con spargisale 5 pz. H.cm.21 H. 8 1/4"
 Cruet and salt cellar set 5 pcs cl. 30 (x2) oz. 10 1/8 (x2)
 Service huile-vinaigre 5 pièces cl. 8 (x3) oz. 2 3/4 (x3)
 Essig-Ölgestell 5-Tlg.
 Vinagreras 5 pza

509



mm. 1,2 Completo oliera con spargisale 4 pz. H.cm.21 H. 8 1/4"
 Cruet and salt cellar set 4 pcs cl. 30 (x2) oz. 10 1/8 (x2)
 Service huile-vinaigre 4 pièces cl. 8 (x2) oz. 2 3/4 (x2)
 Essig-Ölgestell 4-Tlg.
 Vinagreras 4 pza

508



mm. 1,2 Oliera H.cm.21 H. 8 1/4"
 Cruet cl. 30 (x2) oz. 10 1/8 (x2)
 2 pièces huile-vinaigre
 Essig-Ölgestell 2 Tlg.
 Vinagreras 2 pza

510



mm. 1,2 Spargisale portastecchi con base H. cm.14 H. 5 1/2"
 Salt cellar w/toothpick container w/base cl. 8 (x3) oz. 2 3/4 (x3)
 Sel, poivre, porte cure-dents a/socle
 Salz-Pfeffer-Zahnstocherbehälter 3-tlg.
 Sal & Pimenta & palillero 3 pza

350



Cristallo per spargisale art. 510
 Salt and pepper container for art. 510
 Cristal pour art. 510
 Ersatzglass für Art. 510
 Cristal por saleros art. 510
 cl. 8
 oz. 2 3/4

Ampolla
 Cruet
 Huilliere
 Öl-/Essigflasche
 Vinagrera
 H cm. 18 - cl. 30
 H 7 1/8" - oz. 10 1/8

510ST



Portastecchi senza base cl. 8 oz. 2 3/4
 Toothpick container w/out base
 Porte cure-dents sans/socle
 Zahnstocherbehälter ohne Fuß
 Palillero sin pedestal

611



mm. 1,2 Formaggera
Parmesan cheese basin
Fromagère
Käsedose
Quesera - Azucarero
cl. 20 oz. 6 3/4

512

430491SS



Cristallo per spargisale art. 512-602
Crystal glass container for art. 512-602
Cristal avec capsule pour art. 512-602
Erzatzglass mit Kapsel für art. 512-602
Cristal por saleros art. 512-602
cl. 11 - oz. 3 3/4

mm. 1,2 Spargisale-portastecchi
Salt cellar with toothpick container
Sel + poivre + cure dents
Salz-Pfeffer-Zahnstocherbehälter
Saleros y pimenteros y palillero
H. cm.14 - cl. 11(x2)
H. 5 1/2" - oz. 3 3/4 (x2)

602

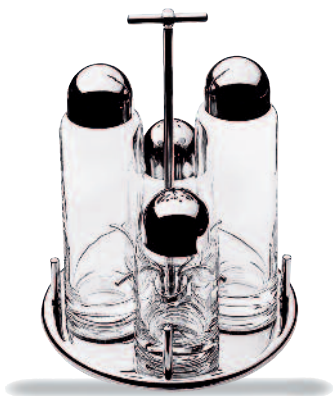

mm. 1,2 Completo oliera con spargisale
Cruet and salt cellar set
Service huile-vinaigre 4 pièces
Essig-Ölgestell 4-tlg.
Convoy vinagreras con saleros
H. cm 19 H. 7 1/2"
cl. 18(x2) oz. 6(x2)
cl. 11(x2) oz. 3 3/4(x2)

601

430602



mm. 1,2 Oliera
Cruet
2 pièces huile-vinaigre
Essig-Ölgestell
Vinagreras
H. cm 19 H. 7 1/2"
cl. 18(x2) oz. 6(x2)

603



mm. 1,2 Oliera portacondimenti
Cruet for aromatic condiments
Huilière pour aromatiques condiments
Gewürzmenage
Vinagreras para aromaticos
y condimentos
H. cm 14,5 H. 5 3/4"
cl. 11(x2) oz. 3 3/4(x2)

430491

304



304
mm 1,2 Portamarmellata a 3 scomparti
Jam pack holder 3 compt.
Porte-confiture 3 comp.
Marmeladegestell 3 Einsätze
Marmeladero 3 comp.
H. cm. 19 - H. 7 1/2"

604

mm. 1,2 Oliera a 3 pezzi
Cruet 3 pcs
Huilière 3 pcs
Menage 3-Tlg.
Vinagreras 3 pzas
H. cm. 19 -cl.18(x2)-cl. 11
H. 7 1/2" - oz.6(x2) oz.3 3/4

231



mm. 0,8	Piatto ovale da portata bordo rinforzato	cm. 25 x 17	9 7/8" x 6 3/4"
	Oval serving plate with reinforced edges	cm. 30 x 21	11 3/4" x 8 1/4"
	Plat oval de service bord renforcé	cm. 35 x 24	13 3/4" x 9 1/2"
	Bratenplatte oval	cm. 40 x 27	15 3/4" x 10 5/8"
	Fuente ovalada borde reforzado	cm. 45 x 32	17 3/4" x 12 5/8"
		cm. 50 x 35	19 5/8" x 13 3/4"
		cm. 60 x 41	23 5/8" x 16 1/8"

241



mm. 0,8	Piatto ovale da portata pesce bordo rinforzato	cm. 55 x 24
	Oval serving fish plate with reinforced edges	cm. 70 x 29
	Plat à poisson oval bord renforcé	
	Fischplatte, oval	21 5/8" x 9 1/2"
	Fuente pescado borde reforzado	27 1/2" x 11 3/8"

233



mm. 1,2	Piatto ovale da portata mod. pesante	cm. 30 x 22	11 3/4" x 8 5/8"
	Oval serving plate with reinforced edges heavy mod.	cm. 35 x 26	13 3/4" x 10 1/2"
	Plat oval de service bord renforcé Mod. pesant	cm. 40 x 28	15 3/4" x 11"
	Bratenplatte, oval, schweres Mod.	cm. 45 x 31	17 3/4" x 12 1/4"
	Fuente ovalada nuevo modelo	cm. 50 x 34	19 5/8" x 13 3/8"

243



mm. 1,2	Piatto ovale da portata pesce mod. pesante	cm. 55 x 25
	Oval serving fish plate heavy weight	cm. 70 x 27
	Plat à poisson modèle Pesant	
	Fischplatte, oval, schweres Mod.	21 5/8" x 9 7/8"
	Fuente ovalada pescado nuevo modelo	27 1/2" x 10 5/8"

251



mm. 0,8	Piatto rotondo da portata bordo rinforzato	Ø cm. 27	Ø 10 5/8"
	Round serving plate with reinforced edges	Ø cm. 30	Ø 11 3/4"
	Plat rond de service bord renforcé	Ø cm. 35	Ø 13 3/4"
	Bratenplatte, rund	Ø cm. 40	Ø 15 3/4"
	Bandeja redonda borde reforzado		

269



mm. 0,8	Copripiatto sovrapponibile	GALA	Ø cm.28	Ø 11"
	Stackable cover for round plate	»		
	Couvre-plat	»		
	Stapelbarer Teller cloche	»		
	Cubre platos	»		



263



mm. 0,8 Piatto tondo per legumi a 3 sc. Ø cm. 27 Ø 10 5/8"
 3 sections vegetable dish
 Plat à légumes rond - 3 compt.
 Teller rund 3 Abteilungen
 Bandeja para legumbres 3 comp.

264



mm. 0,8 Coperchio per piatto tondo art. 263 Ø cm. 25 Ø 9 7/8"
 Lid for art. 263
 Couvercle pour plat rond art. 263
 Deckel für Teller 3 Abtlg.
 Tapa para bandeja redonda art. 263

266



mm. 0,8 Piatto ovale per legumi a 2 sc. cm. 30 x 21 11 3/4" x 8 1/4"
 2 section vegetable dish
 Plat à légumes oval - 2 comp.
 Teller oval, 2 Abteilungen
 Bandeja para legumbres 2 comp.

267



mm. 0,8 Coperchio per piatto ovale art. 266 cm. 27 x 18 10 5/8" x 7 1/8"
 Lid for art. 266
 Couvercle pour plat oval art. 266
 Deckel für Teller, 2 Abtlg.
 Tapa para bandeja ovalada art. 266

235



mm. 1,2 Vassoio per gratin cm. 35 x 20 13 3/4" x 7 1/8"
 Tray for "gratin" cm. 40 x 24 15 3/4" x 9 1/2"
 Plat à "gratin"
 Gratinplatte
 Bandeja gratinar
 15 3/4" x 9 1/2"

236



mm. 0,8 Coperchio per Art. 235 cm. 35 x 20 13 3/4" x 7 1/8"
 Lid for Art. 235 cm. 40 x 24 15 3/4" x 9 1/2"
 Couvercle pour Art. 235
 Deckel für Art. 235
 Tapa para Art. 235

253



mm. 0,8 Cloche per piatto rotondo
Cloche for round plate
Cloche pour plat rond
Tellercloche für Bratenplatte rund
Tapa para fuente redonda

Ø cm. 27	Ø 10 5/8"
Ø cm. 35	Ø 13 3/4"
Ø cm. 40	Ø 15 3/4"

245



mm. 0,8 Cloche per piatto ovale
Cloche for oval plate
Cloche pour plat oval de service
Tellercloche für Bratenplatte oval
Tapa para fuente ovalada

cm. 30	11 3/4"
cm. 35	13 3/4"
cm. 40	15 3/4"
cm. 45	17 3/4"
cm. 50	19 5/8"

211



mm. 0,6 Vassoio rettangolare per pasticceria
Rectangular tray for cakes
Plat à tarte rectangulaire
Gebäckplatte, rechteckig
Bandeja

cm. 26 x 19	10 1/4" x 7 1/2"
cm. 31 x 21	12 1/4" x 8 1/4"

238



mm. 1,2 Vassoio per gratin e gastronomia
Tray for "Gratin-gastronomy"
Plat à "Gratin et gastronomie"
Gratinplatte für Gastronomie
Bandeja para gratinar y gastronomia

cm. 25 x 18	9 7/8" x 7 1/8"
cm. 30 x 22	11 3/4" x 8 5/8"
cm. 35 x 25	13 3/4" x 9 7/8"
cm. 40 x 29	15 3/4" x 11 3/8"
cm. 45 x 31	17 3/4" x 12 1/4"

247



mm. 0,8 Cloche con pomolo per sottopiatto
Cloche with knob for under plate
Cloche pour sous-assiette
Tellercloche
Tapa para fuente redonda

Ø cm. 7,5	Ø 3"
Ø cm. 10	Ø 4"
Ø cm. 10,5	Ø 4 1/16"
Ø cm. 13	Ø 5 1/16"
Ø cm. 13,2	Ø 5 1/5"
Ø cm. 14	Ø 5 1/2"
Ø cm. 14,5	Ø 5 5/7"
Ø cm. 20	Ø 7 7/8"
Ø cm. 22	Ø 8 5/8"
Ø cm. 24	Ø 9 1/2"
Ø cm. 26	Ø 10 1/4"
Ø cm. 28	Ø 11"
Ø cm. 30	Ø 12 1/8"
Ø cm. 31	Ø 12 1/8"
Ø cm. 32	Ø 12 5/8"
Ø cm. 33	Ø 13"

268



mm. 0,8 Copripiatto sovrapponibile
Stackable cover for round plate
Couvre-plat
Stapelbarer Tellercloche
Cubre platos

Ø cm. 20	Ø 7 7/8"
Ø cm. 24	Ø 9 1/2"
Ø cm. 26	Ø 10 1/4"
Ø cm. 27	Ø 10 5/8"
Ø cm. 28	Ø 11"
Ø cm. 30	Ø 11 3/4"
Ø cm. 31	Ø 12 3/8"
Ø cm. 33	Ø 13"

732



mm. 1,2 Zuppiera nuovo modello
 Soup tureen new mod.
 Soupière nouveau modele
 Suppenterrine neues Mod.
 Sopera nuevo Modelo

Ø cm. 14 - lt. 0,6	Ø 5 1/2" - oz. 20 1/4
Ø cm. 18 - lt. 1,2	Ø 7" - oz. 40 5/8
Ø cm. 20 - lt. 1,8	Ø 7 7/8" - oz. 60 7/8
Ø cm. 22 - lt. 2,5	Ø 8 5/8" - oz. 84 1/2
Ø cm. 24 - lt. 3,1	Ø 9 1/2" - oz. 104 7/8
Ø cm. 26 - lt. 3,9	Ø 10 1/4" - oz. 131 7/8
Ø cm. 28 - lt. 5,1	Ø 11" - gal. 1 1/4

782



mm. 1,2 Legumiera nuovo modello
 Vegetable dish new model
 Légumiere nouveau modele
 Lègumier neues Modell
 Legumbrera nuevo Modelo

Ø cm. 14 - lt. 0,6	Ø 5 1/2" - oz. 20 1/4
Ø cm. 18 - lt. 1,2	Ø 7" - oz. 40 5/8
Ø cm. 20 - lt. 1,8	Ø 7 7/8" - oz. 60 7/8
Ø cm. 22 - lt. 2,5	Ø 8 5/8" - oz. 84 1/2
Ø cm. 24 - lt. 3,1	Ø 9 1/2" - oz. 104 7/8
Ø cm. 26 - lt. 3,9	Ø 10 1/4" - oz. 131 7/8
Ø cm. 28 - lt. 5,1	Ø 11" - gal. 1 1/4

736



mm. 1,2 Coperchio per art. 732 - 782
 Lid for art. 732 - 782
 Couvercle pour art. 732 - 782
 Deckel für art. 732 - 782
 Tapa para art. 732 - 782

Ø cm. 14	Ø 5 1/2"
Ø cm. 18	Ø 7"
Ø cm. 20	Ø 7 7/8"
Ø cm. 22	Ø 8 5/8"
Ø cm. 24	Ø 9 1/2"
Ø cm. 26	Ø 10 1/4"
Ø cm. 28	Ø 11"

701



10131140

mm. 1,2 Salsiera mod. "Aladino" cl. 10 oz. 3 3/8
 Gravy boat mod. "Aladino" cl. 15 oz. 5 1/8
 Saucière mod. "Aladino" cl. 30 oz. 10 1/8
 Sauciere mod. "Aladino"
 Salsera mod. "Aladino"

Mestolino per salsa Lungn. cm. 18,7 Long. 7 3/8
 Ladle for gravy boat
 Cuillère à sauce
 Saucenlöffel
 Cacillo para salsera

511



430511SS

mm. 0,8 Completo spargisale-portastecchi
 Salt-cellar with toothpick container
 Sel+poivre+porte cure-dents
 Salz+Pfeffer+Zahnstocherbehälter
 Saleros y pimentero y palillero

H cm. 14	H 5 1/2"
cl. 8	oz. 2 3/4

731



mm. 1,2 Zuppiera monoporzione demitasse
 Soup cup with base
 Soupiere sur socle avec anses
 Suppentasse auf Fuss
 Taza para sopa con pedestal

Ø cm 12	Ø 4 3/4"
cl. 35	oz. 117/8

772



mm. 0,8 Molla per ghiaccio
Ice tongs
Pince à glaçon
Eiszange
Pinzas hielo
Lungh. cm. 15,5
Length 6 1/8"

778



mm. 2,0 Molla per ghiaccio
Ice tongs
Pince à glaçon
Eiszange
Pinzas hielo
Lungh. cm. 18
Length 7 1/8"

382

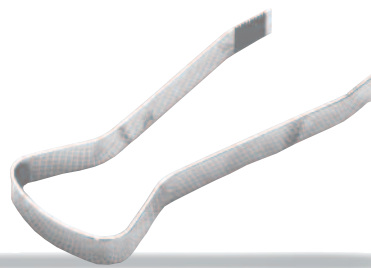

mm. 2,0 ERGONOMICA
Molla per ghiaccio
Ice tongs
Pince à glaçon
Eiszange
Pinzas hielo
Lungh. cm. 17
Length 6 5/8"

774



mm. 0,8 Molla per dolci
Pastry tongs
Pince à gateaux
Gebäckzange
Pinzas dulces
Lungh. cm. 19
Length 7 1/2"

777



mm. 0,8 Molla per spaghetti
Spaghetti/Pasta
tongs
Pince à spaghetti
Spaghettizange
Pinzas spaghetti
Lungh. cm. 21
Length 8 1/4"

775

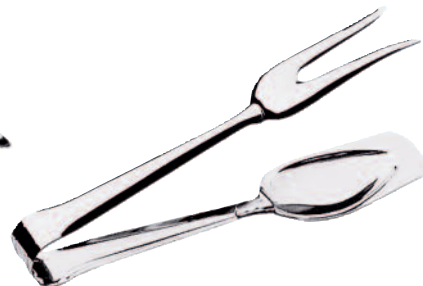

mm. 0,8 Molla per arrosto e verdure
Roasts and vegetables tongs
Pince à salade et à rôti
Servierzange
Pinzas asado y verduras
Lungh. cm. 21
Length 8 1/4"

779



mm. 0,8 Molla per lumache
Escargot tongs
Pince à escargots
Schneckenzange
Pinzas para caracoles
Lungh. cm. 16
Length 6 1/4"

771



mm. 0,8 Molla per zucchero
Sugar tongs
Pince à sucre
Zuckerzange
Pinzas azúcar
Lungh. cm. 14
Length 5 1/2"

752



mm. 0,8 Piattino per lumache Ø cm. 13,5-6pz. Ø 5 3/8" - 6pcs.
 Escargot dish Ø cm. 18 - 12pz. Ø 7 1/8" - 12pcs.
 Plat à escargots
 Schneckenplatte
 Plato caracoles

Molla per lumache Lungh. cm. 16 Length 6 1/4"
 Tongs for snails
 Pince à escargots
 Schneckenzange
 Pinzas para caracoles

741



mm. 0,8 Tegamino friggiuova Ø cm. 16 Ø 6 1/4"
 Frying pan for eggs
 Plat à oeuf
 Eierpfanne
 Plato huevos

904



mm. 1,2 Posacenere cm. 14 x 12 5 1/2" x 4 3/4"
 Ash-tray
 Cendrier
 Ascher
 Cenicero

911



mm. 0,6 Scodella lavadita Ø cm. 12 Ø 4 3/4"
 Finger bowl cl. 30 oz. 10 1/8
 Ecuelle
 Fingerbowl
 Lavadedos

956



mm. 1,2 Cloche copriburro o per antipasti Ø cm. 10,5 Ø 4 1/16"
 Cloche for hors d'oeuvre or butter plate Ø cm. 13 Ø 5 1/16"
 Cloche dome pour assiette
 Cloche für Vorspeisen- oder Butterteller
 Tapa para mantequera o para platos por entremes

528



mm. 1,2 Formaggera ODEON cl. 20 oz. 6 3/4
 Parmesan cheese basin »
 Fromagère »
 Käsedose »
 Quesera-Azucarero »

998



Ø mm 8,0 Portabottiglia
Bottle stand
Porte-bouteille
Rotweinwiege
Portabotella

H cm. 23 H 9"
cm. 21 x 5,5 8 1/4" x 2 1/6"

711



mm. 0,6 Portauovo
Egg-cup
Coquetier
Eierbecher
Huevera

cm 15 x 9 5 7/8" x 3 1/2"

707



mm. 1,2 Portaburro
Butter dish
Beurrer
Butterdose mit Deckel
Mantequera
cm. 11 x 20
4 3/8" x 7 7/8"

799P



799W



799N



Ciotola quadra
Square bowl
Bol, carré
Universalschale auf Holz, quadr.
Cuenco cuadrado
cm. 6 x 6
2 3/8" x 2 3/8"

TRE
"
"
"
"



mm. 1,2 Ciotola per antipasto UNO
Snack bowl »
Bol à snacks »
Snackschale »
Cuenco por entremes »
Ø cm 9
Ø 3 1/2"

544

504



Ø cm. 19
H cm. 27
Ø 7 1/2"
H 10 5/8"

504



cm. 17,5 x 16,5
H cm. 29,5
6 7/8" x 6 1/2"
H 11 3/5"

503



cm. 26 x 12
H cm. 28,5
10 1/4" x 4 3/4"
H 11 1/5"

356



355

cm. 12 x 6
H cm. 28,5

355

Ø mm. 6,0 Cestelli portacondimenti da tavola
Basket for aromatic condiments
Corbeilles pour condiments aromatiques
Tisch-Essig/Öl Flaschenhalter
Cestos para aromaticos y condimentos

mm. 1,2 Cestelli portacondimenti da buffet
Basket for aromatic condiments
Corbeilles pour condiments aromatiques
Buffet-Essig/Öl Flaschenhalter
Cestos para aromaticos y condimentos

4 3/4" x 2 1/3"
H 11 1/5"

446



mm. 1,2 8 1/2
Portatoast
Toast rack
Porte-toast
Toastständer
Portatostadas
cm. 21 x 7,5
8 1/4" x 3"

451

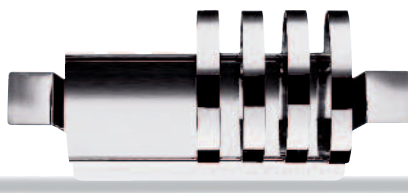

mm. 1,0 Portatoast
Toast rack
Porte-toast
Toastständer
Portatostadas
cm. 21 x 7,5
8 1/4" x 3"

NEW



mm. 1,2 Portatoast
Toast rack
Porte-toast
Toastständer
Portatostadas
cm. 21 x 7,5
8 1/4" x 3"

903



mm. 0,6 Segnaposto
Table number stand
Numéro de table
Tischnummern-Aufsteller
Numero de mesa
cm 11 x 9
4 3/8" x 3 1/2"

996

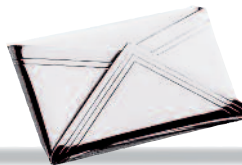

mm. 0,6 Portanumero
Table number stand
Numéro de table
Tischnummern-Ständer
Numero de mesa
cm. 9,5 x 5
3 3/4" x 2"



Ø cm.10
H cm 10
Ø 4"
H 4"

901

289



mm.1,2
Porta cono patatine GALA
Chips cone holder "
Porte pommes frites "
Eis-Kartoffenbehälter "
Porta cono patatas fritas "
Ø cm.6 - H cm. 10
Ø 2" - H 3 7/8"



726
mm.1,2
Coppa Martini
Martini Glass
Verre à Martini
Martini glas
Vaso para Martini
cl. 11 oz. 3 3/4
cl. 20 oz. 6 3/4

727



727
mm.1,2
Coppa per intermezzo
Intermezzo cup
Coupe à intermezzo
Sorbetschale
Copa para intermezzo
cl. 4
oz. 1 3/8

152

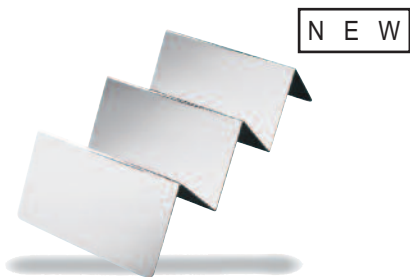

mm. 1,2 Porta tacos
Tacos Holder
Support pour tacos
Tacoshalter
Porta Tacos

cm 20 x 10 7 3/4" x 3 7/8"
H cm 5 H 2"

314



mm. 1,2 Vassoio concavo ERGONOMICA
Crescent tray »
Plateau concave »
Konkave Tablett »
Bandeja concavo »

cm 40 x 19 15 3/4" x 7 1/2"
cm 55 x 28 21 5/8" x 11"

232



mm. 1,2 Vassoio per self service
Cafeteria tray
Plateau pour self service
Tablett für self service
Bandeja para self service

cm. 40 x 30 15 3/4" x 11 7/8"

905



mm. 0,8 Portagrissini
Bread sticks holder
Porte gressin
Grissini-Halter
Porta bastoncillos de pan

Ø cm 10 Ø 3 7/8"
H cm. 17 H 6 5/8"

675



mm. 0,8 Portabottiglia antirollio per yacht
Yachting non-slip bottle holder
Cache eau minerale avec anneau antiderapant
Antiroll-Spezialflaschenhalter für Yachten
Portabotella antibalanco para yacht

Ø cm. 10
H cm. 17
Ø 3 7/8"
H 6 5/8"

496AC

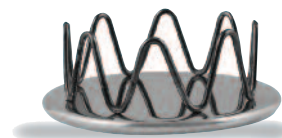

mm. 1,2 Salvagoccia bottiglia vino rosso
Anti-drop wine bottle coaster
Dessous de bouteille de vin
anti-goutte
Tropfen einflaschenuntersetzer
Posabotella antigoteo por vino

Ø cm. 11,5 Ø 4 1/2"

229



mm. 1,2 Portasalse per fiorentina o tartara
Sauce set for Florentine or Tartar steak
Service à sauce pour Florentin ou Tartare
Sauce Set für Florentine oder Tartar Steak
Servicio para salsa por bistek Tartara y Florentina

cl. 35 (x4) oz. 117/8 (x4)

230



mm. 1,2 Completo portasalse per fiorentina o tartara
Complete sauce set for Florentine or Tartar steak
Service à sauce complet pour Florentin ou Tartare
Sauce Set für Florentine oder Tartar Steak
Servicio para salsa por bistek Tartara y Florentina

cm. 40 x 27 15 3/4" x 10 5/8"
cl. 35 (x4) oz. 117/8 (x4)

094



mm. 1,2 Cestino rotondo CAMELLA
Round basket " Ø cm. 27 Ø 10 5/8"
Corbeille ronde " "
Obstschale, rund " "
Frutero redondo " "

098



mm. 1,2 Vassoio CAMELLA
Tray " cm. 35 x 23 13 3/4" x 9 1/4"
Plateau " " cm. 40 x 27 15 3/4" x 10 5/8"
Tablett " "
Bandeja " "

721



mm. 1,2 Coppa termica gelato e macedonia
Insulated ice cream cup/salad fruit bowl
Coupe thermique a glace et macedonie
Isolier-Eisfruchtbecher mit Deckel
Copa térmica helado y macedonia

Ø cm. 8,5 Ø 3 1/3"
cl. 15 oz. 6

356



mm. 1,2 Cestello portacondimenti da buffet
Basket for aromatic condiments
Corbeille pour condiments aromatiques
Buffet-Essig/Öl Flaschenhalter
Cesto para aromaticos y condimentos"

cm. 26 x 12 H cm. 28,5
10 1/4" x 4 3/4"
H 11 1/5"

280



mm. 1,2 Set per ceviche in acciaio inossidabile 18/10
18/10 Stainless Steel ceviche set
Set pour ceviche en acier inoxydable 18/10
Cevicheset in Rostfreie Stahl 18/10
Cevichera en acero inoxidable 18/10

607 Ø cm. 27 H cm. 13,5 lt. 5
58922 Ø cm. 22 H cm. 14 cl. 220

607 Ø 10 1/2" H 5 1/4" gal. 1 1/3
58922 Ø 8 1/2" H 5 1/2" oz. 74 3/8

281



mm. 1,2 Set per ceviche in policarbonato
Polycarbonate ceviche set
Set pour ceviche en polycarbonate
Cevicheset in Polikarbonat
Cevichera en policarbonado

58928 Ø cm. 28 H cm. 17,3 lt. 6,03
58922 Ø cm. 22 H cm. 14 cl. 220

58928 Ø 11" H 6 5/8" oz. 202 1/2
58922 Ø 8 1/2" H 5 1/2" oz. 74 3/8

994C



mm. 1,2 Portanumero piccolo
Mini table number stand
Numbers etched to order
Mini marquer de table
Mini Tischnummernständer
Porta numero de mesa pequeño

H cm. 7 H 2 3/4"

913



mm. 1,0 Porta badge in acciaio magnetico
Badge holder in magnetic steel
Porte-badge en acier magnétique
Badge-Halter in magnetischem Stahl
Porta tarjeta de acero magnético

cm. 8 x 4,5 3 1/7" x 1 3/4"

225



Cloche trasparente
Transparent cloche
Cloche transparente
Transparent Tellercloche
Tapa transparente

Ø cm. 12 Ø 4 3/4"
Ø cm. 22 Ø 8 1/2"
Ø cm. 28 Ø 11"

mm. 1,2 Portastuzzicadenti con base
Toothpick container with base
Porte-cure-dents avec socle
Zahnstocherbehälter auf Fuss
Porta-palillos con base

Ø cm. 4 Ø 1 1/2"
H cm. 5,8 H 2 1/4"
cl. 5 oz. 1 3/4

709



047



Colino da cocktail
Cocktail strainer
Passoire à cocktail
Cocktailsieb
Colador para coctelera

cm. 22 8 2/3"

049



Cavatappi
Cork screw / Bottle opener
Ouvre boîte - Ouvre-bouteilles
Korkenzieher
Abrebotellas

H cm. 19 H 7 1/2"

025



Grattugia
Grater
Râpe
Reibe
Rallador

cm. 23 9"

048



Schiaccianoci
Nutcracker
Casse noix
Nussknacker
Rompenueces

cm. 20 7 7/8"

473



ATTILA
Cavatappi
Cork screw / Bottle opener
Décapsuleur
Korkenheber
Abrebotellas

cm. 10 3 7/8"

mm. 1,2

10001108



Cucchiaino per caviale
Caviar spoon
Cuillère à caviar
Kaviarlöffel
Cucharita caviar

cm. 11,8 4 2/3"

447



JOKER
Macinapepe
Pepper mill
Moulin à poivre
Pfeffermühle
Molinillo de pimienta

Ø cm. 4 Ø 1 1/2"
H cm. 15 H 5 7/8"

464



ETNA
Macinasale
Salt mill
Moulin à sel
Salzmühle
Molinillo de sal

Ø cm. 4 Ø 1 1/2"
H cm. 15 H 5 7/8"

466



MANOLO
Macinapeperoncino
Chilli mill
Moulin à piment
Chilimühle
Molinillo de chile

Ø cm. 4 Ø 1 1/2"
H cm. 15 H 5 7/8"

462



PARDON
Tagliatartufi
Truffles slicer
Coupe truffes
Trüffel Hobel
Cortador de trufas

cm. 20 x 8 7 7/8" x 3 1/7"

104



mm. 1,2 EPOQUE
Sottopiatto e Sottobottiglia
Charger and Bottle coaster
Assiette de bienvenue et
Dessous de bouteille
Platz- und Flaschenteller
Bajo plato y Posabotella

Ø cm. 34 Ø 13 3/8"
Ø cm. 14,5 Ø 5 3/4"

133

671



mm. 1,0 Vasetto portafiori H. cm. 14 H. 5 1/2"
Flower vase
Vase à fleur
Blumenvase
Florero

757



mm. 1,2 ORCHIDEA
 Appoggia borse
 Bags support
 Soutier de sacs
 Beutelstand
 Apoya bolsas

cm. 30 x 40 11 7/8" x 15
 H cm. 30 3/4"
 H 11 7/8"

758



mm. 1,2 PEONIA
 Appoggia borse
 Bags support
 Soutier de sacs
 Beutelstand
 Apoya bolsas

cm. 37 x 31 14 5/8" x 12
 H cm. 33 1/4"
 H 13"

755



mm. 1,2 IRIS
 Appoggia borse
 Bags support
 Soutier de sacs
 Beutelstand
 Apoya bolsas

Ø cm. 35 Ø 13 3/4"
 H cm. 38 H 15"

756



mm. 1,2 BIANCOSPINO
 Appoggia borse
 Bags support
 Soutier de sacs
 Beutelstand
 Apoya bolsas

Ø cm. 37 Ø 14 5/8"
 H cm. 37 H 14 5/8"





Tea Time

94003

976S



mm. 1,2 Servizio per zucchero
Sugar set
Service pour sucre
Zucker Menage
Juego azucar



94004
cl. 15 (x3) oz. 5 1/8 (x3)
cl. 15 (x4) oz. 5 1/8 (x4)



976C
mm. 1,2 Portasalatini impilabile
Stackable snack server
Support à snack empilable
Stapelbare Relish-Pickles-Gestell
Servicio por entremes impilable
Ø cm. 20 Ø 7 7/8"
cl. 15 (x3) oz. 5 1/8 (x3)
976C
Ø cm. 20 Ø 7 7/8"
H cm 15 H 5 7/8"
cl. 15 (x3) oz. 5 1/8 (x3)

984

974



Alzata portapiatti
Afternoon tea stand
Présentoir à gateau
Dessert-Serviergestell
Soporte platos

984
Ø cm 22
H.cm.45
985
Ø cm 18
H.cm.33
989
Ø cm 30
H.cm.52
984
Ø 8 3/16"
H 17 1/4"
985
Ø 7 1/8"
H 13"
989
Ø 11 3/4"
H 20 1/2"
98402
Ø cm 22 Ø 8 3/16"
H cm.35 H 13 3/4"

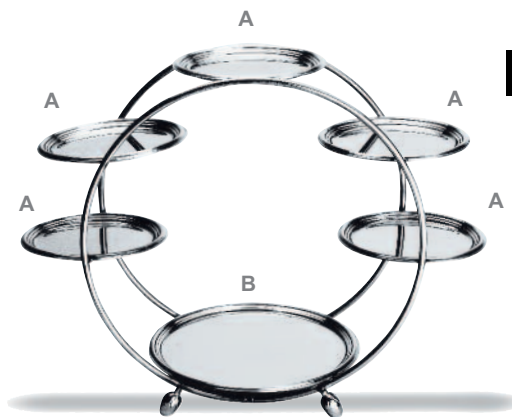

mm. 1,2 Presentoire
2 misure
2 sizes
2 tailles
2 Größen
2 tamaños
A Ø cm.13 (x5) A Ø 5 1/8" (x5)
B Ø cm.19 B Ø 7 1/2"
A Ø cm.19 (x5) A Ø 7 1/2" (x5)
B Ø cm.27 B Ø 10 5/8"



257



Porta pasticcini c/pied.
Petit-fours stand with base
Porte-petits-fours a/socle
Petits Fours-Ständer
Porta dulces con pedestal

Ø cm. 14 Ø 5 1/2"
H cm. 8,7 H 3 1/2"
Ø cm. 20 Ø 7 7/8"
H cm. 13 H 5 1/8"
Ø cm. 28 Ø 11"
H cm. 14,5 H 5 3/4"

mm. 1,2

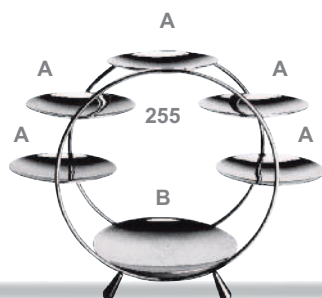

Presentoire
2 misure
2 sizes
2 tailles
2 Größen
2 tamaños
mm. 1,2

25506

A Ø cm.6 (x5)
B Ø cm.7,5
H cm. 13

25508

A Ø cm.7,5 (x5)
B Ø cm.11
H cm. 17

25506

A Ø 2 2/5" (x5)
B Ø 3"
H 5 1/8"

25508

A Ø 3" (x5)
B Ø 4 1/3"
H 6 5/8"

258



Porta pasticcini c/pied.
Petit-fours stand w/base
Porte-petits-fours a/socle
Petits Fours-Ständer
Porta dulces c/pedestal

Ø cm. 14
Ø cm. 20
Ø cm. 28
H cm. 27
Ø 5 1/2"
Ø 7 7/8"
Ø 11"
H 10 5/8"

mm. 1,2

721



Coppa per gelato e macedonia
Ice-cream /salad fruit bowl w/stand
Coupe à glace et macédoine
Eisfrüchteschale
Copa helado y macedonia

Ø cm. 8,5
cl. 15
Ø 3 3/4"
oz. 5 1/8

mm. 1,2

451



Portatoast
Toast rack
Porte-toast
Toastständer
Portatostadas

cm. 21 x 7,5
8 1/4" x 3"

mm. 1,0

935



Porta macaron
Macarons server
Porte macarons
Macaronsträger
Porta macaron

Ø cm 15
H cm 10
Ø 5 7/8"
H 4"

mm. 1,2

702



Mini burriera con coperchio
Small butter dish w/lid
Petit beurrier a/couvercle
Mini Butterdose m/Deckel
Platillo para mantequilla c/tapa

cm. 12 x 6
cl. 15
4 3/4" x 2 1/3"
oz. 5 1/8

mm. 1,2

526

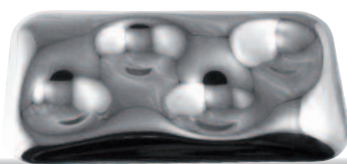

Vassoio rett. a 4 comp.
Rectang. tray 4 comp.
Plateau rect. ou 4 plac.
Tablett, rech. 4 Eins.
Bandeja rect. 4 posic.

cm. 23 x 13
9" x 5 1/8"

mm. 1,2

524



Set cremiera Koji 5pz c/vass.
Cream set Koji 5 pcs w/tray
Set à crème Koji 5 pcs a/plat.
Sahne Set 5-Tlg. Koji m/Tab.
Servicio leche Koji 5pzs. c/band.

cm. 12 x 12
cl. 25
4 3/4" x 4 3/4"
oz. 8 2/5

mm. 1,2

52405

265



Vassoio per pasticceria
Patisserie tray
Plateau pour patisserie
Patisserie Tablett
Bandeja para pasteleria

cm. 24,5 x 17
cm. 30 x 21
cm. 34 x 24

9 5/8" x 6 3/4"
11 3/4" x 8 1/4"
13 3/8" x 9 1/2"

mm. 1,2

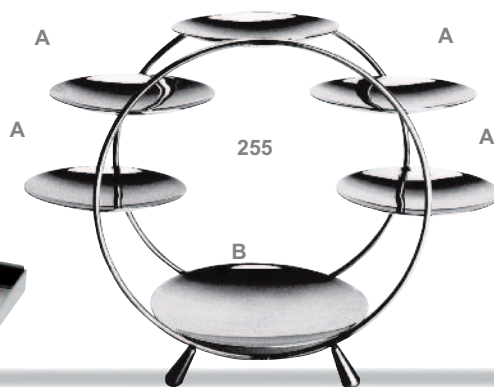

Presentoire
3 misure
3 sizes
3 tailles
3 Größen
3 tamaños

mm. 1,2

25514
A Ø cm.14 (x5)
B Ø cm.20
H cm. 30

25520
A Ø cm.20 (x5)
B Ø cm.24
H cm. 30

25524
A Ø cm.24 (x5)
B Ø cm.28
H cm. 41

25514
A Ø 5 1/2" (x5)
B Ø 7 7/8" (x5)
H 11 3/4"

25520
A Ø 7 7/8" (x5)
B Ø 9 1/2" (x5)
H 11 3/4"

25524
A Ø 9 1/2" (x5)
B Ø 11" (x5)
H 16 3/5"

205



Vassoio per pasticceria con piedistallo
Patisserie tray with foot
Plateau pour patisserie avec socle
Patisserie Tablett mit Fuss
Bandeja para pasteleria con pies

cm. 26 x 12
cm. 60 x 12
H cm. 13

10 1/4" x 4 3/4"
23 3/5" x 10 1/5"
H 5 1/9"

mm. 1,2

206

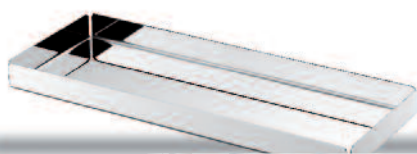

Vassoio per pasticceria
Patisserie tray
Plateau pour patisserie
Patisserie Tablett
Bandeja para pasteleria

cm. 26 x 12
cm. 60 x 12

10 1/4" x 4 3/4"
23 3/5" x 10 1/5"

mm. 1,2



Portabustine da zucchero
Sugar packet holder
Pot à sucre
Zuckerstangengefäß
Azucarera

mm. 1,2

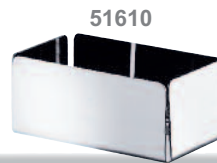

516
cm. 10 x 7
H cm. 3

51610
cm. 10 x 5
H cm. 4,5

516
4" x 2 3/4"
H 1 1/8"

51610
4" x 2"
H 1 3/4"

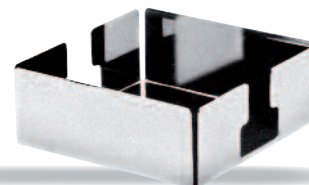

Portatovaglioli
Napkin holder
Distributeur de serviettes
Serviettenhalter
Portaservilletas

cm. 13 x 13

5 1/9" x 5 1/9"

mm. 1,2

704





Caffè

621



mm. 1,2	Caffettiera con piedistallo	Tazze	1	cl. 15	5 1/8 oz.
	Coffee pot with base	Cups	2	cl. 27	9 1/8 oz.
	Cafetière avec socle	Bols	4	cl. 37	12 1/2 oz.
	Kaffeekanne auf Fuss	Tassen	6	cl. 55	18 1/8 oz.
	Cafetera con pedestal	Tazas	8	cl. 85	28 1/4 oz.
			10	cl. 110	37 1/4 oz.
			12	cl. 150	50 1/4 oz.
		16	cl. 200	67 1/8 oz.	

622



mm. 1,2	Teiera con piedistallo	Tazze	2	cl. 35	11 7/8 oz.
	Tea pot with base	Cups	4	cl. 50	16 7/8 oz.
	Théière avec socle	Bols	6	cl. 70	23 1/8 oz.
	Teekanne auf Fuss	Tassen	8	cl. 95	32 1/8 oz.
	Tetera con pedestal	Tazas	10	cl. 120	40 7/8 oz.

623



mm. 1,2	Lattiera con piedistallo	Tazze	1	cl. 15	5 1/8 oz.
	Milk jug with base	Cups	2	cl. 27	9 1/8 oz.
	Pot à lait avec socle	Bols	4	cl. 37	12 1/2 oz.
	Milchkanne auf Fuss	Tassen	6	cl. 55	18 1/8 oz.
	Jarra lechera con pedestal	Tazas	8	cl. 85	28 1/4 oz.
			10	cl. 110	37 1/4 oz.
			12	cl. 150	50 1/4 oz.
		16	cl. 200	67 1/8 oz.	

624



mm. 1,2	Zuccheriera con piedistallo	Tazze	2	cl. 15	5 1/8 oz.
	Sugar bowl with base	Cups	4	cl. 20	6 3/4 oz.
	Sucrier avec socle	Bols	6	cl. 27	9 1/8 oz.
	Zuckerdose auf Fuss	Tassen	8	cl. 35	11 1/8 oz.
	Azucarero con pedestal	Tazas			



624P

646



mm. 1,2	Caffettiera termica con piedistallo	Tazze	4	cl. 30	10 1/8 oz.
	Insulated coffee pot with base	Cups	6	cl. 60	20 1/4 oz.
	Cafetière thermique avec socle	Bols	12	cl. 150	50 1/4 oz.
	Isolier-Kaffeekanne auf Fuß	Tassen			
	Cafetera térmica con pedestal	Tazas			

648



mm. 1,2	Caraffa termica c/fermaghiaccio e piedistallo			cl. 150
	Insulated water pitcher w/ice-trap and base			
	Carafe à eau avec attrape-glace et socle			
	Isolier-Wasserkrug auf Fuss			50 1/4 oz.
	Jarra agua c/tope y pedestal			

641



mm. 1,2	Caffettiera	Tazze	1	cl. 15	5 1/8 oz.
	Coffee pot	Cups	2	cl. 27	9 1/8 oz.
	Cafetière	Bols	4	cl. 37	12 1/2 oz.
	Kaffeekanne	Tassen	6	cl. 55	18 5/8 oz.
	Cafetera	Tazas	8	cl. 85	28 3/4 oz.
			10	cl. 110	37 1/4 oz.
			12	cl. 150	50 3/4 oz.
			16	cl. 200	67 5/8 oz.

642



mm. 1,2	Teiera	Tazze	1	cl. 20	6 1/4 oz.
	Tea pot	Cups	2	cl. 35	11 1/8 oz.
	Théière	Bols	4	cl. 50	16 1/8 oz.
	Teekanne	Tassen	6	cl. 70	23 5/8 oz.
	Tetera	Tazas	8	cl. 95	32 1/8 oz.
			10	cl. 120	40 5/8 oz.

643



mm. 1,2	Lattiera	Tazze	1/2	cl. 10	3 5/8 oz.
	Milk jug	Cups	1	cl. 15	5 1/8 oz.
	Pot à lait	Bols	2	cl. 27	9 1/8 oz.
	Milchkanne	Tassen	4	cl. 37	12 1/2 oz.
	Jarra lechera	Tazas	6	cl. 55	18 5/8 oz.
			8	cl. 85	28 3/4 oz.
			10	cl. 110	37 1/4 oz.
			12	cl. 150	50 3/4 oz.
			16	cl. 200	67 5/8 oz.

644



644P

mm. 1,2	Zuccheriera	Tazze	2	cl. 15	5 1/8 oz.
	Sugar bowl	Cups	4	cl. 20	6 1/4 oz.
	Sucrier	Bols	6	cl. 27	9 1/8 oz.
	Zuckerdose	Tassen	8	cl. 35	11 1/8 oz.
	Azucarero	Tazas			

647



mm. 1,2	Caraffa termica per acqua c/fermaghiaccio	cl. 150
	Insulated water pitcher w/ice-trap	
	Carafe à eau avec attrape-glace	
	Isolier-Wasserkrug	50 1/4 oz.
	Jarra agua c/tope	

645



mm. 1,2	Caffettiera termica	Tazze	4	cl. 30	10 1/8 oz.
	Insulated coffee pot	Cups	6	cl. 60	20 1/4 oz.
	Cafetière thermique	Bols	12	cl. 150	50 1/4 oz.
	Isolier-Kaffeekanne	Tassen			
	Cafetera térmica	Tazas			

940



940E
 Inserto per art. 940
 Insert for art. 940
 Insért pour art. 940
 Einsatz für Art. 940
 Inserto por art. 940

940E



94005



mm. 1,2 Servizio per caffè macchiato
 Café au lait set
 Service pour café au lait
 Café au lait-Set
 Juego café au lait

939
 H cm 18
 cl. 90

939
 H 7 1/8"
 oz. 30 1/2

940
 H cm 18
 cl. 97

940
 H 7 1/8"
 oz. 32 7/8

mm. 1,2 Servizio per caffè macchiato
 5pcs Sugar, milk and coffee set
 Service sucre, lait et café 5 pièces
 Milch-Kaffee-Zucker Set 5-Tlg.
 Juego leche, café y azúcar 5 piezas

H cm 18 H 7 1/8"
 cl. 30 (x5) oz. 10 1/8 (x5)

94003



mm. 1,2 Servizio per zucchero 3 pezzi
 Sugar set 3 pcs.
 Service pour sucre 3 pièces
 Zucker Menage 3-Tlg
 Juego azúcar 3 piezas

cl. 11 (x3) oz. 3 3/4 (x3)

94004



mm. 1,2 Servizio per zucchero 4 pezzi
 Sugar set 4 pcs.
 Service pour sucre 4 pièces
 Sahne-/Zucker-Set 4-Tlg
 Juego azúcar 4 piezas

cl. 11 (x4) oz. 3 3/4 (x4)

649



639

mm. 1,2 Bricco BOMBATA cl. 20
 Jug
 Cruche
 Milchkännchen
 Jarra

oz. 6 3/4

NEW



mm. 1,2 Molla per zucchero ed aperitivi
 Sugar and cocktails tongs
 Pince à sucre et apéritifs
 Zucker- und Cocktailszange
 Pinzas azúcar y aperitivos

Lungh. cm. 10,8 Length 4 1/4"

631



mm. 1,2

Caffettiera
Coffee pot
Cafetière
Kaffeekanne
Cafetera

Tazze	2 cl. 24	8 1/8 oz.
Cups	4 cl. 34	11 1/2 oz.
Bols	6 cl. 46	15 1/2 oz.
Tassen	8 cl. 63	21 1/8 oz.
Tazas	10 cl. 100	33 3/8 oz.
	12 cl. 150	50 1/4 oz.
	16 cl. 200	67 1/8 oz.

632



mm. 1,2

Teiera
Tea pot
Théière
Teekanne
Tetera

Tazze	2 cl. 40	13 1/2 oz.
Cups	4 cl. 50	16 1/8 oz.
Bols	6 cl. 68	23 oz.
Tassen	8 cl. 90	30 1/2 oz.
Tazas		

633



mm. 1,2

Lattiera
Milk jug
Pot à lait
Milchkanne
Jarra lechera

Tazze	1 cl. 10	3 1/8 oz.
Cups	2 cl. 24	8 1/8 oz.
Bols	4 cl. 34	11 1/2 oz.
Tassen	6 cl. 46	15 1/2 oz.
Tazas	8 cl. 63	21 1/4 oz.
	10 cl. 100	33 3/8 oz.
	12 cl. 150	50 1/4 oz.
	16 cl. 200	67 1/8 oz.

634



mm. 1,2

Zuccheriera
Sugar bowl
Sucrier
Zuckerdose
Azucarero

Tazze	4 cl. 15	5 1/8 oz.
Cups	6 cl. 22	7 1/2 oz.
Bols	8 cl. 28	9 1/2 oz.
Tassen		
Tazas		

635



mm. 1,2

Brocca per acqua con fermagliaccio
Water pitcher with ice-trap
Carafe à eau avec attrape-glace
Eiswaserkrug
Jarra agua c/topo

cl. 100
cl. 200

33 1/5 oz.
67 1/3 oz.

651



mm. 1,2

Caffettiera	Tazze	2	cl. 25	8 1/2 oz.
Coffee pot	Cups	4	cl. 37	12 1/2 oz.
Cafetière	Bols	6	cl. 52	17 1/8 oz.
Kaffeekanne	Tassen	8	cl. 70	23 1/8 oz.
Cafetera	Tazas	10	cl. 100	33 1/8 oz.
		12	cl. 150	50 1/4 oz.
		16	cl. 200	67 1/8 oz.

652



mm. 1,2

Teiera	Tazze	2	cl. 40	13 1/2 oz.
Tea pot	Cups	4	cl. 55	18 1/8 oz.
Théière	Bols	6	cl. 70	23 1/8 oz.
Teekanne	Tassen	8	cl. 97	32 1/4 oz.
Tetera	Tazas			

653



mm. 1,2

Lattiera	Tazze	1	cl. 10	3 1/8 oz.
Milk jug	Cups	2	cl. 25	8 1/2 oz.
Pot à lait	Bols	4	cl. 37	12 1/2 oz.
Milchkanne	Tassen	6	cl. 52	17 1/8 oz.
Jarra lechera	Tazas	8	cl. 70	23 1/8 oz.
		10	cl. 100	33 1/8 oz.
		12	cl. 150	50 1/4 oz.
		16	cl. 200	67 1/8 oz.

654



mm. 1,2

Zuccheriera	Tazze	2	cl. 13	4 1/8 oz.
Sugar bowl	Cups	4	cl. 18	6 1/8 oz.
Sucrier	Bols	6	cl. 22	7 1/2 oz.
Zuckerdose	Tassen	8	cl. 30	10 1/8 oz.
Azucarero	Tazas			

361



mm. 1,2
Caffettiera
Coffee pot
Cafetière
Kaffeekanne
Cafetera

Tazze	1	cl. 10	3 7/8 oz.
Cups	4	cl. 34	11 1/2 oz.
Bols	6	cl. 50	16 7/8 oz.
Tassen	8	cl. 75	25 3/8 oz.
Tazas	10	cl. 97	32 1/5 oz.
	16	cl. 200	67 3/8 oz.

362



mm. 1,2
Teiera
Tea pot
Théière
Teekanne
Tetera

Tazze	2	cl. 35	11 7/8 oz.
Cups	4	cl. 50	16 7/8 oz.
Bols	6	cl. 75	25 3/8 oz.
Tassen	8	cl. 97	32 1/5 oz.
Tazas			

363



mm. 1,2
Lattiera
Milk jug
Pot à lait
Milchkanne
Jarra lechera

Tazze	1	cl. 10	3 7/8 oz.
Cups	4	cl. 34	11 1/2 oz.
Bols	6	cl. 52	17 3/8 oz.
Tassen	8	cl. 75	25 3/8 oz.
Tazas	16	cl. 200	67 3/8 oz.

364



mm. 1,2
Zuccheriera porta bustine
Sugar packets holder
Sucrier à sachets
Zuckerdose/Zuckerstangengefäß
Azucarera

364T	cl. 22	7 1/2 oz.
364A	cl. 22	7 1/2 oz.
364B	cl. 10	3 3/8 oz.

366



mm. 1,2
Caffettiera termica
Insulated coffee pot
Cafetière thermique
Isolier-Kaffeekanne
Cafetera térmica

Tazze	6	cl. 50
Cups	8	cl. 75
Bols		
Tassen		16 7/8 oz.
Tazas		25 3/8 oz.

367



mm. 1,2
Teiera termica
Insulated tea pot
Théière thermique
Isolier-Teekanne
Tetera térmica

Tazze	4	cl. 50
Cups	6	cl. 75
Bols		
Tassen		16 7/8 oz.
Tazas		25 3/8 oz.



516

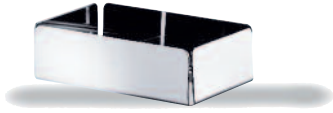

mm. 1,2 Portabustine da zucchero
Sugar packet holder
Pot à sucre
Zuckerstangengefäß
Azucarera

cm. 10 x 7 4" x 2 3/4"
H cm. 3 H 1 1/8"

206

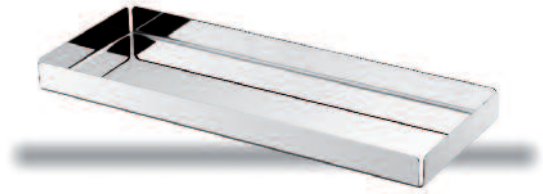

mm. 1,2 Vassoio per pasticceria
Pâtisserie tray
Plateau pour pâtisserie
Pâtisserie Tablett
Bandeja para pasteleria

cm. 26 x 12 10 1/4" x 4 3/4"
cm. 60 x 12 23 3/5" x 10 1/5"

136



mm. 1,2 Vassoio CAFE' VIENNA cm. 26 x 19 10 1/4" x 7 1/2"
Tray »
Plateau »
Kaffeetablett »
Bandeja »

704

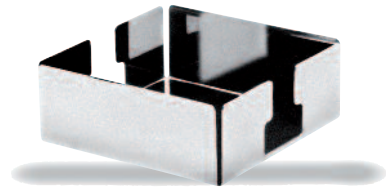

mm. 1,2 Portatovaglioli
Napkin holder
Distributeur de serviettes
Serviettenhalter
Portaservilletas

cm. 13 x 13 5 1/9" x 5 1/9"

902



mm. 1,2 Portabastoncini da zucchero
Sugar bags holder
Pot à sucre
Zuckerstangengefäß
Azucarera

Ø cm 7 H 3 1/4"
H cm 8 Ø 2 3/4"
cl. 37 oz. 12 1/2

700



mm. 1,2 Zuccheriera
Sugar container
Sucriere
Zuckerdose
Azucarero

Ø cm 10 Ø 4"
cl.35 oz 11 7/8

594



mm. 1,2 Cremlera con piedistallo UNO cl.16 oz. 5³/₈
 Cream jug with base »
 Crémier avec socle »
 Sahnegießer/Milchkännchen »
 Jarrita lechera con pedestal »

595



mm. 1,2 Zuccheriera con piedistallo UNO cl. 24 oz. 8¹/₈
 Sugar bowl with base »
 Sucrier avec socle »
 Zuckerdose auf Fuss »
 Azucarero con pedestal »

499



mm. 1,2 MINIMA cm.15 x 11 5¹/₈" x 4³/₈"
 Portabustine da zucchero 4 sc. H.cm.14 H. 5¹/₂"
 Sugar packets holder 4 compt.
 Pot à sucre 4 comp.
 Zuckerstangengefäß 4 Eins.
 Azucarera 4 comp.

706



mm. 1,2 Porta salviette lavamani cm. 15 x 9 5⁷/₈" x 3¹/₂"
 Tray for hand towels
 Plateau porte serviettes
 Tablett für Stoffservietten
 Bandeja portaservilletas

703



10201144
 Lungh. cm. 16,5
 Length 6¹/₂"

mm.1,2 Set per latte macchiato Ø cm. 10 Ø 3⁷/₈"
 Latte Macchiato Set cl. 36 oz. 12³/₈
 Service pour Latte Macchiato
 Latte Macchiato-Set
 Servicio para café con leche

720



mm. 1,2 Portaburro e marmellata cm. 17,5 x 7,5 6⁷/₈" x 3"
 Butter and jam dish
 Beurre et confiture
 Butter-Marmeladen-Platte
 Porta mantequilla y mermelada

Bar



661

941

665



Portacucchiaini per bar Ø cm. 9 Ø 3 1/4"
Coffee spoons stand
Pot à cuillères pour bar
Löffelbecher
Porta-cucharitas para bar
mm. 0,8

Secchiello per spumante Ø cm. 18 Ø 7 1/4"
Sparkling wine cooler H cm. 18,5 H 7 1/8"
Seau à champagne lt. 4 gal. 1
Wein- und Sektkühler
Cubo para champany
mm. 1,2

Secchiello per ghiaccio Ø cm. 13,5 Ø 5 1/8"
Ice-bucket with knobs H cm. 13 H 5 1/8"
Seau à glaçons cl. 150 oz. 50 1/4
Eisgefäß
Cubitera hielo
mm. 0,8

708

545



mm. 1,2 Piattino portamonete
Cash tray
Plat à addition
Zahlteller
Bandeja porta monedas

cm. 11 x 15 4 1/8" x 5 1/8"

mm. 1,2 Dosatore
Jigger
Doseur
Barmaß
Medida

cl. 2 e 4 oz. 1
oz. 1 1/8

Agitatore cl. 25 oz. 8 1/2
Shaker cl. 50 oz. 16 1/8
Shaker cl. 75 oz. 25 1/8
Shaker
Coctelera

729

551



mm. 1,2 Coppa per punch Ø cm. 38
Punch bowl lt. 15
Bol à punch
Punchbowl Ø 15"
Cazo ponche 4 gal.

Mestolo coppa per punch
Punch bowl ladle
Cuiller à punch
Bowlenlöffel
Cazo ponche

mm. 0,8

Agitatore Boston con bicchiere
Boston shaker
Boston shaker à cocktail et verre
Boston Shaker
Coctelera Boston

cl. 75 oz. 25 1/8

Colori disponibili a pag. 342
Available colors at page 342
Couleurs disponibles
à page 342
Sehen Sie erhaltlichen Farben
an Seite 342
Ver colores à pagina 342

972

973



972

973

973P

972P

mm. 1,2
972-972P
PALACE
 Secchiello per ghiaccio
 Ice bucket
 Seau à glaçons
 Eisgefäß
 Cubitera hielo

Ø cm 15 Ø 5 7/8"
 H cm 18 H 7 1/8"
 cl.150 oz. 50 3/4

mm. 1,2
973-973P
PALACE
 Secchiello per spumante
 Sparkling wine cooler
 Seau à champagne
 Wein- und Sektkühler
 Cubo para champany

Ø cm 20,5 Ø 8 1/8"
 H cm 24,5 H 9 5/8"
 lt. 5,0 gal. 1 1/3

666F

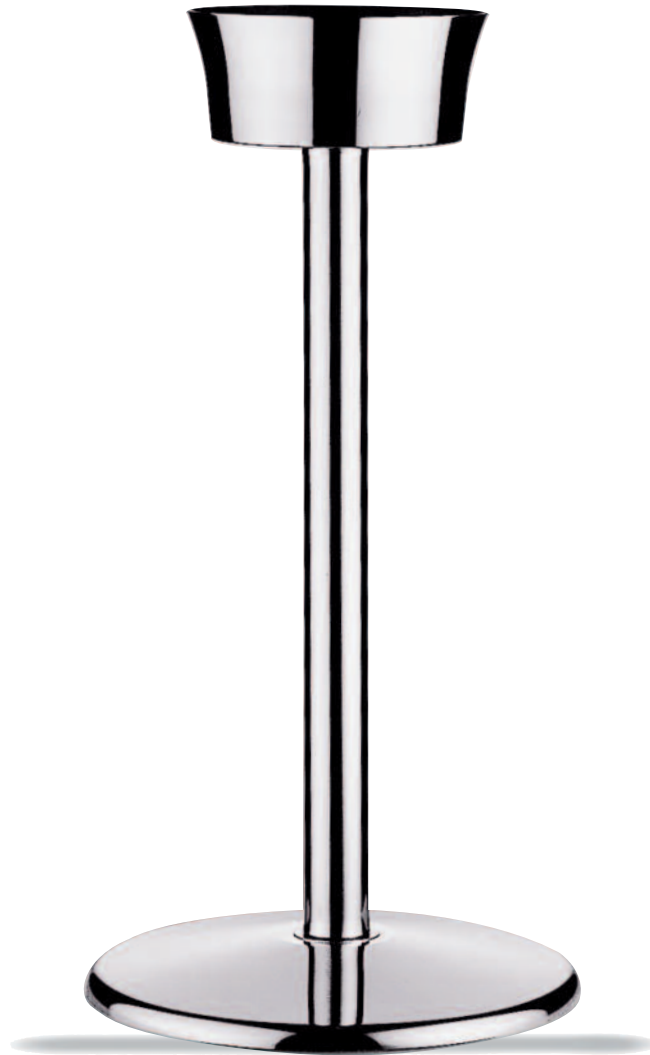

mm. 1,2
PALACE
 Colonna portasecchiello spumante
 Wine cooler stand w/weighted base
 Pied pour seau à champagne
 Weinkühlerständer
 Columna porta cubo champany

H cm. 67,5 H 26 5/8"

370



mm. 1,2 IMMAGINA
 Secchiello per spumante
 Sparkling wine cooler
 Seau à champagne
 Wein- und Sektkühler
 Cubo para champany

cm 27 x 20,5 10 5/8" x 8"
 H cm 21,5 H 8 1/2"
 lt. 6,5 gal. 1 3/4

371



mm. 1,2 IMMAGINA
 Secchiello per ghiaccio
 Ice bucket
 Seau à glaçons
 Eisgefäß
 Cubitera para hielo

cm 16,6 x 10 6 1/2" x 4"
 H cm 14,2 H 8 1/2"
 cl. 180 oz. 60 7/8

666H



mm. 1,2 IMMAGINA
 Colonna portasecchiello spumante
 Wine cooler stand
 Pied pour seau à champagne
 Weinkühlerständer
 Columna porta cubo champany

H cm. 61,5 H 24 1/5"

670



670 mm.1,2
 Secchiello per ghiaccio
 Ice bucket with grill
 Seau à glaçons
 Eisgefäß
 Cubitera hielo
 Ø cm.14 - H cm.13 - cl. 150
 Ø 5 1/2" - H 5 1/8" - oz. 50 3/4



662 mm.1,2
 Rinfrescavino bianco da 1 bottiglia
 White wine cooler for 1 bottle
 Seau à vin blanc
 Weissweinkühler für 1 Flasche
 Cubo para refrescar 1 botella de vino blanco
 Ø cm.16 - H cm.20 - lt. 3
 Ø 6 1/4" - H 7 7/8" - oz. 101 1/2



663 mm.1,2
 Rinfrescavino spumante da 1 bottiglia
 Sparkling wine cooler for 1 bottle
 Seau à Champagne 1 bouteille
 Champagnerkühler für 1 Flasche
 Cubo para refrescar 1 botella de vino spum.
 Ø cm.18 - H cm.21 - lt. 4,5
 Ø 7 1/8" - H 8 1/4" - gal. 1 1/4

664



664 mm.1,2
 Rinfrescavino spumante da 2/3 bottiglie o Magnum
 Sparkling wine cooler for 2/3 bottles or Magnum
 Seau à champagne 2/3 bouteilles ou Magnum
 Champagnerkühler für 2/3 Flaschen oder Magnum
 Cubo para refrescar 2/3 botellas de vino spumante
 Ø cm.22,5 - H cm.23 - lt. 8,5
 Ø 8 7/8" - H 9" - gal. 2 1/4

666

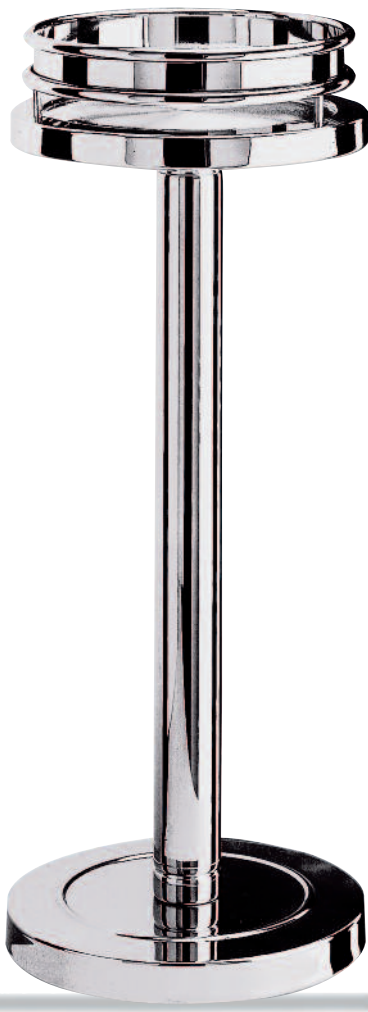

mm. 1,2
 Colonna portasecchiello spumante H cm. 65 H 25 5/8"
 Wine cooler stand
 Pied pour seau à champagne
 Weinkühlerstander
 Columna porta cubo champany

67704



mm. 0,8
 Portaghiaccio termico con coperchio
 Insulated ice-bucket with lid
 Seau à glaçon thermique avec couvercle
 Isolier-Eisgefäß
 Cubitera hielo con tapa
 lt. 3/4
 lt. 4
 oz. 25 3/8
 gal. 1

67701

676



mm. 0,8
 Glacette termica per 1 bottiglia
 Insulated glacette for 1 bottle
 Glacette thermique pour 1 bouteille
 Getränkekühler 1 Flasche
 Cubo térmico para 1 botella
 Ø cm. 13
 H cm. 20
 cl. 150
 Ø 5 1/8"
 H 7 7/8"
 oz. 50 3/4

681



681 mm.1,2
MICHELANGELO
Rinfrescavino spumante da 2/3 bottiglie o Magnum
Sparkling wine cooler for 2/3 bottles or Magnum
Seau à champagne 2/3 bouteilles ou Magnum
Champagnerkühler für 2/3 Flaschen oder Magnum
Cubo para refrescar 2/3 botellas de vino spumante
Ø cm.22,5 - H cm.23 - lt. 8,5
Ø 8 7/8" - H 9" - gal. 2 1/4



680 mm.1,2
MICHELANGELO
Rinfrescavino spumante da 1 bottiglia
Sparkling wine cooler for 1 bottle
Seau à champagne 1 bouteille
Champagnerkühler für 1 Flasche
Cubo para refrescar 1 botella de vino spum.
Ø cm.18 - H cm.21 - lt. 4,5
Ø 7 1/8" - H 8 1/4" - gal. 1 1/4



679 mm.1,2
MICHELANGELO
Rinfrescavino bianco da 1 bottiglia
White wine cooler for 1 bottle
Seau à vin blanc
Weissweinkühler für 1 Flasche
Cubo para refrescar 1 botella de vino blanco
Ø cm.16 - H cm.20 - lt. 3
Ø 6 1/4" - H 7 7/8" - oz. 10 1/2

678



678 mm.1,2
MICHELANGELO
Secchiello per ghiaccio
Ice bucket with grill
Seau à glaçons
Eisgefäß
Cubitera hielo
Ø cm.14 - H cm.13 - cl. 150
Ø 5 1/2" - H 5 1/8" - oz. 50 3/4

672



mm. 1,2 Portaggiaccio termico con anello e molla
Insulated ice-bucket with handle and tongs for ice
Seau à glaçon thermique avec anse et pinçe
Isolier-Eisgefäß und Eiszange
Cubitera hielo con asa y pinzas hielo
lt. 3/4 oz. 25 3/8

666A

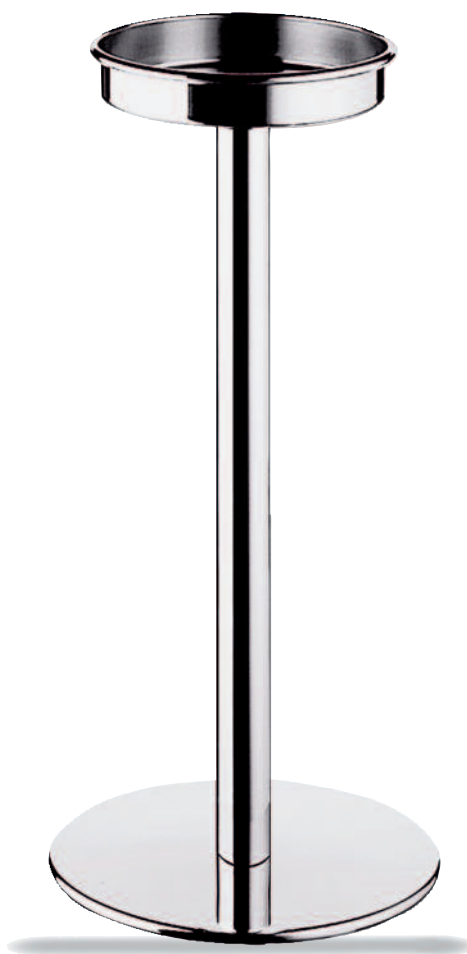

mm. 1,2 GALA
Colonna portasecchiello spumante
Wine cooler stand
Pied pour seau à champagne
Weinkühlerständer
Columna porta cubo champany
H cm. 60 H 23 3/8"

660



mm. 0,8 Servizio per champagne
Insulated Champagne set
Service pour champagne
Champagnergetränkühler
Servicio para champagne
Ø cm. 26 Ø 10 1/4"
H cm. 22 H 8 2/3"
cl. 150 oz. 50 3/4

67301



67304



mm. 1,2 GIOTTO
Portaghiaccio termico con coperchio
Insulated ice-bucket with lid
Seau à glaçons thermique
avec couvercle
Isolier-Eisgefäß
Cubitera hielo con tapa

Ø cm 14 Ø 5 1/2"
H cm 13 H 5"
cl.72 oz. 24 1/3

Ø cm 24 Ø 9 1/2"
H cm 22 H 8 5/8"
lt. 4,0 gal. 1

669



668

mm. 1,2 GIOTTO
Secchiello spumante e ghiaccio
Sparkling wine cooler / Ice bucket
Seau à champagne et à glaçons
Wein- Sektkühler / Eisgefäß
Cubo para champany y para hielo

Ø cm 24 Ø 9 1/2"
H cm 23 H 9"
lt. 5,0 gal. 1 1/3

Ø cm 14,5 Ø 5 2/3"
H cm 13 H 5 1/9"
lt. 1,4 oz. 47 1/3

666E

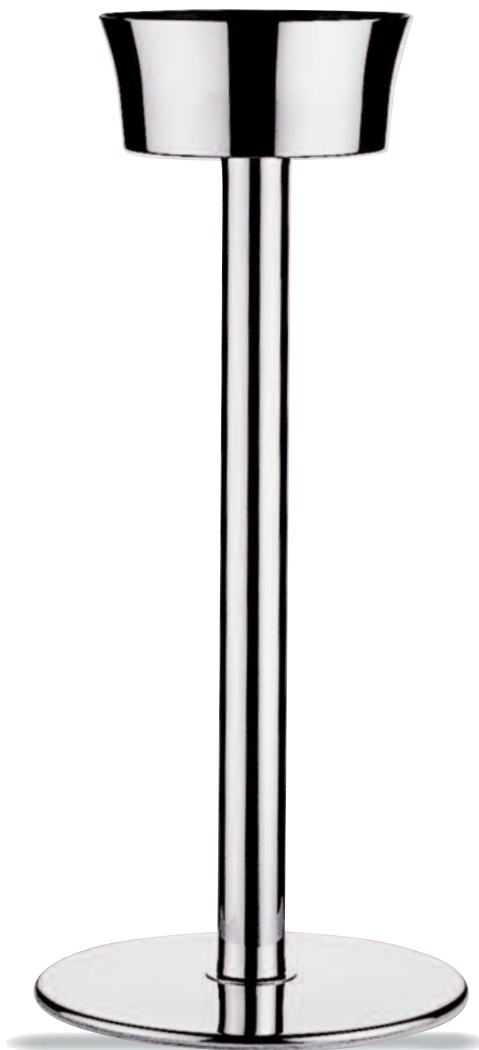

mm. 1,2 GIOTTO
Colonna portasecchiello spumante
Wine cooler stand
Pied pour seau à champagne
Weinkühlerständer
Columna porta cubo champany

H cm. 67,5 H 26 5/8"

948



mm. 1,2 LESS IS MORE
Rinfrescavino spumante da 2 bottiglie o Magnum
Sparkling wine cooler for 2 bottles or Magnum
Seau à champagne 2 bouteilles ou Magnum
Champagnerkühler für 2 Flaschen oder Magnum
Cubo para refrescar 2 botellas de vino spumante

cm. 35 x 15
H cm. 18
lt. 9

13 3/4" x 5 7/8"
H 7 1/8"
gal. 2 1/2

430



mm. 1,2 FASHION
Rinfrescavino spumante da 2 bottiglie o Magnum
Sparkling wine cooler for 2 bottles or Magnum
Seau à champagne 2 bouteilles ou Magnum
Champagnerkühler für 2 Flaschen oder Magnum
Cubo para refrescar 2 botellas de vino spumante

H cm. 21
cm. 21 x 21
lt. 9

H 8 1/4"
8 1/4" x 8 1/4"
gal. 2 1/2

666M

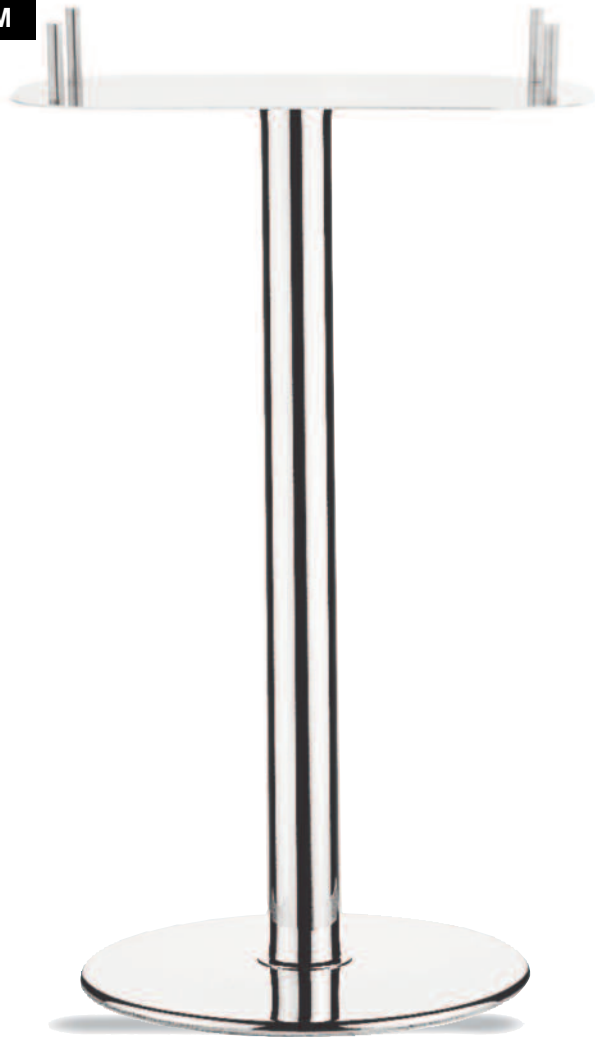

mm. 1,2 LESS IS MORE
Colonna portasecchiello spumante
Wine cooler stand
Pied pour seau à champagne
Weinkühlerständer
Columna porta cubo champany

H cm. 62
cm. 38 x 25

H 24 2/5"
15" x 9 7/8"

666L

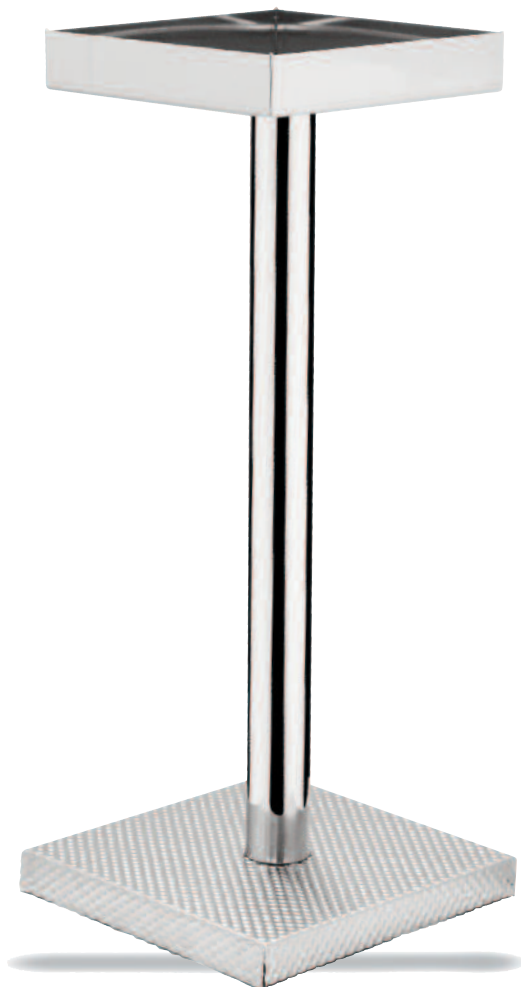

mm. 1,2 FASHION
Colonna portasecchiello spumante
Wine cooler stand
Pied pour seau à champagne
Weinkühlerständer
Columna porta cubo champany

H cm. 61,5
H 24 1/5"

597



mm. 1,2 UNO
 Secchiello per ghiaccio
 Ice bucket
 Seau à glaçons
 Eisgefäß
 Cubitera hielo

Ø cm. 16,8 Ø 6 5/8"
 H cm. 11 H 4 3/8"
 cl. 150 oz. 50 3/4

598



mm. 1,2 UNO
 Secchiello per spumante
 Sparkling wine cooler
 Seau à champagne
 Wein- und Sektkühler
 Cubo para champany

Ø cm. 29 Ø 11 3/8"
 H cm. 18,5 H 7 1/4"
 lt. 8 gal. 2

666W

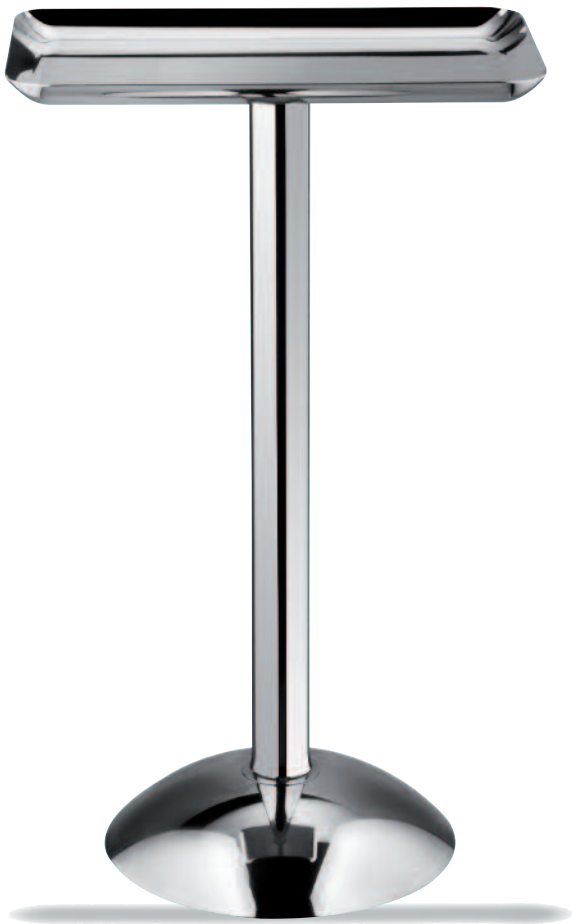

mm. 1,2 Gueridon d'appoggio rettangolare H cm. 62 H 24 2/5"
 Rectangular gueridon cm. 38 x 25 15" x 9 7/8"
 But de canapé rectangulaire
 Gueridon, rechteckig
 Gueridon rectangular

666Z



mm. 1,2 Gueridon d'appoggio ovale H cm. 62 H 24 2/5"
 Oval gueridon cm. 46 x 31 18 1/8" x 12 1/4"
 But de canapé oval
 Gueridon, oval
 Gueridon oval

599



mm. 1,2 UNO
 Secchiello per spumante
 Sparkling wine cooler
 Seau à champagne
 Wein- und Sektkühler
 Cubo para champany

Ø cm. 29 Ø 11 3/8"
 H cm. 18,5 H 7 1/4"
 lt. 8 gal. 2

589



Ciotola tonda
 Round bowl
 Bol ronde
 Früchtekorb rund
 Cuenco redondo

Ø cm. 28 Ø 11"
 H cm. 17,3 H 6 5/8"
 lt. 6,03 qt. 6 1/3

599

58928

7 colori disponibili - pag. 310 - 311
 7 colors available - pageS 310 - 311
 7 couleurs disponibles - pag. 310 - 311
 7 verschiedenen Farben verfügbar - Seiten 310 - 311
 7 colores disponibles - pag. 310 - 311

589 - Ø cm. 28
 Ø 11"



666C

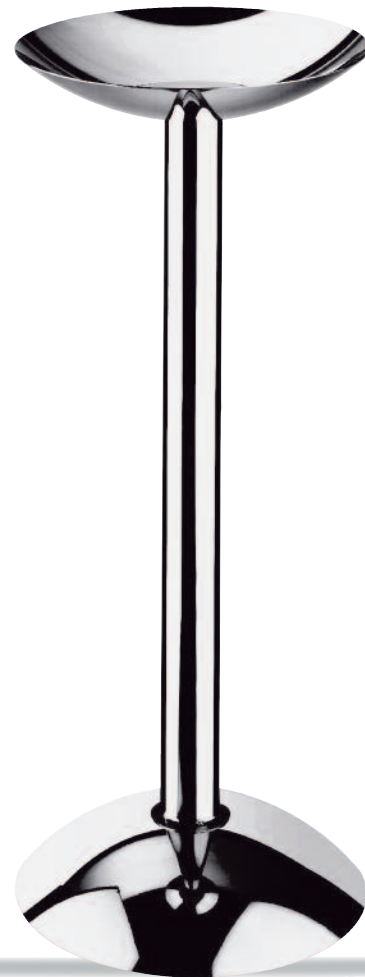

mm. 1,2 UNO
 Colonna portasecchiello spumante
 Wine cooler stand
 Pied pour seau à champagne
 Weinkühlerständer
 Columna porta cubo champany

H cm. 67,5 H 26 5/8"

598

59870

Logo traforato a richiesta
 Fretworked logo on demand
 Logo ajourée sur demande
 Firmenzeichen gelocht auf Verlangen
 Logo perforado en demanda

589 - Ø cm. 64
 Ø 25 1/4"

589 - Ø cm. 28
 Ø 11"



598
 mm. 1,2 Secchiello Ø cm. 29 Ø 11 3/8"
 Basket H cm. 18,5 H 7 1/4"
 Corbeille lt. 8 gal. 2
 Fruchtkorb
 Cesta

59870
 mm. 1,2 Big Champagnera Ø cm. 67,5 Ø 26 3/8"
 Champagne bowl H cm. 43 H 17"
 Bol a champagne lt. 80 gal. 21
 Champagner Bowl
 Cesta para champany

666K



NEW

mm. 1,2 Colonna porta big champagnera H cm. 51 H 20"
Champagne bowl stand
Pied pour bol a champagne
Champagner Bowlständer
Columna porta cesta champany

A



Ambra
Amber
Amber
Amber
Ambar



G



Granato
Garnet
Grenat
Granat
Granate

M



Ametista
Amethyst
Amethyste
Amethyst
Amatista

W



Trasparente
Transparent
Glace
Transparent
Vidrio

Z



Zaffiro
Saphyre
Saphir
Saphir
Zafiro

S



Smeraldo
Emerald
Emeraude
Smaragd
Esmeralda

O



Onice
Onyx
Onyx
Onyx
Onice

909



mm. 1,2 Secchiello per ghiaccio forato
Ice bucket fretworked handles
Seau à glaçons anses ajourée
Eisgefäß mit Griffen
Cubitera hielo asa perforada

cm. 22 x 20 8 3/4" x 7 7/8"
H cm. 11,5 H 4 5/8"
lt. 1,2 oz. 40 1/2

912



mm. 1,2 Secchiello per spumante forato
Sparkling wine cooler fretw. handles
Seau à champagne anses ajourée
Wein- und Sektkühler mit Griffen
Cubo para champany asa perforada

cm. 39 x 36 15 3/8" x 14 1/4"
H cm. 17,5 H 7"
lt. 7 gal. 1 4/5

730



mm. 1,2 Spumantiera 12 bottiglie champagne
Giant champagne bucket for 12 bottles
Seau à champagne géante pour 12 bouteilles
Champagner Bowl für 12 Flaschen
Cubo de champagne gigante para 12 botellas

cm. 75 x 65 29 1/2" x 25 5/8"
H cm. 19 H 7 1/2"
lt. 15 gal. 3 7/8

899



mm. 1,2 Secchiello per ghiaccio
Ice bucket
Seau à glaçons
Eisgefäß
Cubitera hielo

cm. 22 x 20 8 3/4" x 7 7/8"
H cm. 11,5 H 4 5/8"
lt. 1,2 oz. 40 1/2

910



mm. 1,2 Secchiello per spumante
Sparkling wine cooler
Seau à champagne
Wein- und Sektkühler
Cubo para champany

cm. 39 x 36 15 3/8" x 14 1/4"
H cm. 17,5 H 7"
lt. 7 gal. 1 4/5

686



mm. 1,2 Champagnera 5 bott. c/pied. Ø cm. 40 Ø 15 3/4"
 Giant Champagne bucket 5 bot. H cm. 38,5 H 15 1/6"
 Seau à champagne p/5 bott. lt. 15 gal. 4
 Champagner Bowl 5 Fläsche
 Cubo de champagne p/5 bot.

685



mm. 1,2 Champagnera 5 bott. s/pied. Ø cm. 40 Ø 15 3/4"
 Giant Champagne bucket 5 bot. H cm. 21,8 H 8 3/5"
 Seau à champagne p/5 bott. lt. 15 gal. 4
 Champagner Bowl 5 Fläsche
 Cubo de champagne p/5 bot.

666I



mm. 1,2 Colonna portabottiglie spumante H cm. 78 H 30 5/7"
 Wine cooler stand
 Pied pour seau à champagne
 Weinkühlerständer
 Columna porta cubo champany

674



mm. 1,2 Spumantiera termica 5 bott. s/pied. Ø cm. 40 Ø 15 3/4"
 Giant insulated Champagne bucket 5b. H cm. 21,8 H 8 3/5"
 Seau à champagne thermique p/5 bou. lt. 15 gal. 4
 Isolier Champagner Bowl 5 Fläsche
 Cubo térmico para champagne p/5 bot.

380



382
Lungh. cm. 17,5
Length 6⁷/₈"

mm. 1,5

mm. 1,2

ERGONOMICA
Secchiello e molla per ghiaccio
Ice bucket and ice tongs
Seau à glaçons et pince à glaçons
Eisgefäß und Eiszange
Cubitera hielo y pinzas hielo

cl. 200

oz. 67 ⁵/₈

381



mm. 1,2

ERGONOMICA
Secchiello per spumante
Sparkling wine cooler
Seau à champagne
Wein-und Sektkühler
Cubo para champany

lt. 4,5

gal. 1¹/₄

683



mm. 1,2

Secchio per ghiaccio
Ice bucket with grill
Seau à glaçons
Eisgefäß
Cubitera hielo

Ø cm.14 Ø 5¹/₂"
H.cm.13 H. 5¹/₈"
cl. 150 oz. 50³/₄

684



mm. 1,2

Secchio per spumante
Sparkling wine cooler
Seau à champagne
Wein-und Sektkühler
Cubo para champany

Ø cm.23 Ø 9"
H cm.22,5 H 8⁷/₈"
lt. 8,5 gal. 2¹/₄

941



mm. 1,2

Portacannucce
Straw holder
Porta pailles
Strohalm Halter
Porta-palillas

Ø cm. 9 Ø 3 ¹/₄"

10001150



mm. 1,2

Golf club mixer spoon
Golf club mixer spoon
Golf crosse pour cocktail
Golf Schleger für Long drink
Golf club cucharita coctél

cm. 16,5 6 ¹/₂"

438



mm. 1,2

OVO
Secchiello per spumante
Sparkling wine cooler
Seau à champagne
Wein- und Sektkühler
Cubo para champany

Ø cm. 19 Ø 7 1/2"
H cm. 22 H 8 5/8"
lt. 4,5 gal. 1 1/4

439



mm. 1,2

OVETTO
Secchiello per ghiaccio
Ice-bucket
Seau à glaçons
Eisgefäß
Cubitera hielo

Ø cm. 11 Ø 4 3/8"
H cm. 13 H 5 1/8"
cl. 100 oz. 33 7/8

689



mm. 1,2

Secchiello per spumante
Sparkling wine cooler
Seau à champagne
Wein- und Sektkühler
Cubo para champany

Ø cm. 19 Ø 7 1/2"
H cm. 20 H 7 3/4"
lt. 2,5 oz. 84 1/2

688



mm. 1,2

Secchiello per ghiaccio
Ice-bucket
Seau à glaçons
Eisgefäß
Cubitera hielo

Ø cm. 11 Ø 4 3/8"
H cm. 12,5 H 4 7/8"
cl. 55 oz. 18 5/8

658



Cubetto luminoso confez. 72 pezzi cm. 2,5 x 2,5 1" x 1"
LED ice cube 72 pcs. box H cm. 2,5 H 1"
Glaçons lumineux 72 pièces
Eiswürfel LED 72 Stücke
Cubito hielo LED 72 piezas

Idoneo al contatto con gli alimenti.

Suitable for contact with food

Materiale certificato:
LFGB - German Food, Commodities and Animal Feed Code of Law
DIN 10955 - 2004
ISO 11885:2007
BfR Recommendations on Food Contact Materials - part V & VI 2010 & 2010
Regolamento CEE (EU) 10/2011
Regolamento CEE (EC) 1907/2006
Regolamento CEE (EC) 1935/2004

Certified material:
LFGB - German Food, Commodities and Animal Feed Code of Law
DIN 10955 - 2004
ISO 11885:2007
BfR Recommendations on Food Contact Materials - part V & VI 2010 & 2010
Regulation CEE (EU) 10/2011
Regulation CEE (EC) 1907/2006
Regulation CEE (EC) 1935/2004

Durata delle batterie: 12 ore

Battery life: 12 hours

Front Cooking



FRONT COOKING

- Design e performance tecniche combinati alla perfezione
 - Adatte a tutte le fonti di calore e cottura
 - Manici ergonomici
 - Progettate in collaborazione con i più importanti produttori di cucine professionali per far rendere al meglio fuochi ed induzione
-
- Perfect combination of technical performance and design.
 - Suitable for all hobs.
 - Ergonomic handles.
 - Projected in cooperation with the most important manufacturers of professional kitchens, in order to perform hobs and induction at their best.
-
- Design et performance techniques combinées à la perfection
 - Aptes à toutes les font de chaleur et de cuisson
 - Poignées ergonomiques
 - Conçues en collaboration avec les principaux producteurs de cuisines professionnelles afin de rendre les feux et l'induction plus performants.
-
- Perfekte Kombination aus technische Leistung und Design.
 - Für alle Kochfelder geeignet.
 - Ergonomische Griffe.
 - Projektiert in Zusammenarbeit mit den wichtigsten Hersteller von Profiküchen, um Kochfelder und Induktion optimal zur Geltung zu bringen.
-
- Perfecta combinación de prestaciones técnicas y Design.
 - Apto para todas las placas.
 - Asas ergonómicas.
 - Proyectado en cooperación con los más importantes fabricantes de cocinas profesionales, con el fin de realizar las mejores cocinas e inducción.

MEPRA
S.p.A.

Apartments

APARTMENTS

- Design differenti per ogni tipo di stile
- Alte performance su tutti i piani di cottura
- Manici ergonomici ad alta resistenza al calore
- Vasto assortimento di misure
- Different Design for any kind of style.
- High performance on every hobs.
- Heat resistant ergonomic handles.
- Wide assortment of sizes.
- Différents designs pour chaque style
- Hautes performances sur tous les fonds de cuisson
- Poignées ergonomiques à haute résistance à la chaleur
- Large assortiment de tailles.
- Unterschiedliches Design für jeden Stil.
- Höchste Leistung auf allen Kochfeldern.
- Hitzebeständig ergonomisch Griffe.
- Breites Sortiment an Größen.
- Design diferente para cualquier tipo de estilo.
- Alto rendimiento en todas las placas.
- Mangos ergonómicos, resistentes al calor.
- Amplia variedad de tallas.







Acciaio Inossidabile 18/10, cuore in alluminio, esterno in acciaio per induzione
 Superficie esterna ed interna lucidate a specchio
 Maniglie con rivetti in acciaio inossidabile 18/10, a tenuta rinforzata
 Il calore si distribuisce uniformemente su tutta la superficie della pentola
 Maggiore controllo della temperatura di cottura
 Notevole risparmio di energia e tempo
 Minor alterazione delle vitamine e proteine durante la cottura

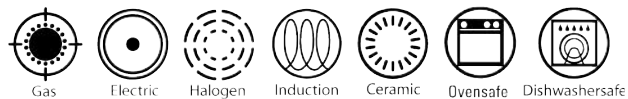

18/10 Stainless Steel, aluminum core, Induction Steel outside
 Mirror polished surfaces, outside and inside
 Handles with strongly fixed 18/10 Stainless Steel rivets,
 The heat is distributed evenly over the surface of the pot
 Greater control of cooking temperature
 Considerable saving of energy and time
 Minor alteration of vitamins and proteins during cooking



Strato interno - Inner layer

Acciaio Inossidabile 18/10 - Il materiale in assoluto più igienico e più facile da pulire
 Stainless Steel 18/10 - The material even more hygienic easier to clean

Strato centrale - Middle layer

Cuore in alluminio - Il materiale leggero, non soggetto a corrosione ed atossico
 Aluminum core - The lightweight, non-corrosive and non-toxic

Strato esterno - Outer layer

Acciaio speciale per induzione
 Special steel for induction



1831

Risottiera e tegame per arrosti e brasati in **Trimetallo** con interno in acciaio inossidabile 18/10 senza rivestimento
Tri-ply Low casserole for risotto and stews.

Ø cm. 24 - Lt. 3,0
 Ø cm. 28 - Lt. 4,0

Ø 9 1/2" - Qt. 3 1/6
 Ø 11" - Qt. 4 1/5



1821

Sauteuse per condimenti e salse in **Trimetallo** con interno in acciaio inossidabile 18/10 senza rivestimento
Tri-ply Casserole for serving sauces, soups and side dishes.

Ø cm. 18 - Lt. 2,0
 Ø cm. 20 - Lt. 3,0
 Ø cm. 22 - Lt. 3,5
 Ø cm. 24 - Lt. 5,0

Ø 7" - Qt. 2 1/9
 Ø 7 1/8" - Qt. 3 1/6
 Ø 8 2/3" - Qt. 3 2/3
 Ø 9 1/2" - Qt. 5 1/3



1801

Pentola in **Trimetallo** con interno in acciaio inossidabile 18/10 senza rivestimento
Tri-ply Deep pot

Ø cm. 20 - Lt. 3,5
 Ø cm. 22 - Lt. 5,0
 Ø cm. 24 - Lt. 6,5

Ø 7 7/8" - Qt. 3 2/3
 Ø 8 2/3" - Qt. 5 1/3
 Ø 9 1/2" - Qt. 6 1/8



1811

Mini casseruole per soufflé, condimenti e salse in **Trimetallo** con interno in acciaio inossidabile 18/10 senza rivestimento
Tri-ply Mini casseroles for soufflé, condiments and sauces

Ø cm. 9 - Lt. 0,25
 Ø 3 1/2" - Qt. 1/4
 Ø cm. 14 - Lt. 1,0
 Ø 5 1/2" - Qt. 1
 Ø cm. 16 - Lt. 2,0
 Ø 6 1/3" - Qt. 2 1/9



1821

Mini casseruole per soufflé, condimenti e salse in **Trimetallo** con interno in acciaio inossidabile 18/10 senza rivestimento
Tri-ply Mini casseroles for soufflé, condiments and sauces

Ø cm. 12 - Lt. 0,6
 Ø 4 2/3" - Qt. 2 1/9



1841
Padella in **Trimetallo**
Tri-ply Frying pan
Poêle à frire
Bratpfanne
Sartén

Ø cm. 22	Ø 8 ² / ₃ "
Ø cm. 26	Ø 10 ¹ / ₄ "
Ø cm. 30	Ø 11 ³ / ₄ "

Acciaio Inossidabile 18/10, cuore in alluminio, esterno in acciaio per induzione
 Superficie esterna ed interna lucidate a specchio
 Maniglie con rivetti in acciaio inossidabile 18/10, a tenuta rinforzata
 Il calore si distribuisce uniformemente su tutta la superficie della pentola
 Maggiore controllo della temperatura di cottura
 Notevole risparmio di energia e tempo
 Minor alterazione delle vitamine e proteine durante la cottura

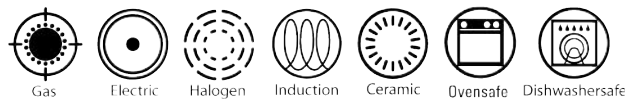

18/10 Stainless Steel, aluminum core, Induction Steel outside
 Mirror polished surfaces, outside and inside
 Handles with strongly fixed 18/10 Stainless Steel rivets,
 The heat is distributed evenly over the surface of the pot
 Greater control of cooking temperature
 Considerable saving of energy and time
 Minor alteration of vitamins and proteins during cooking

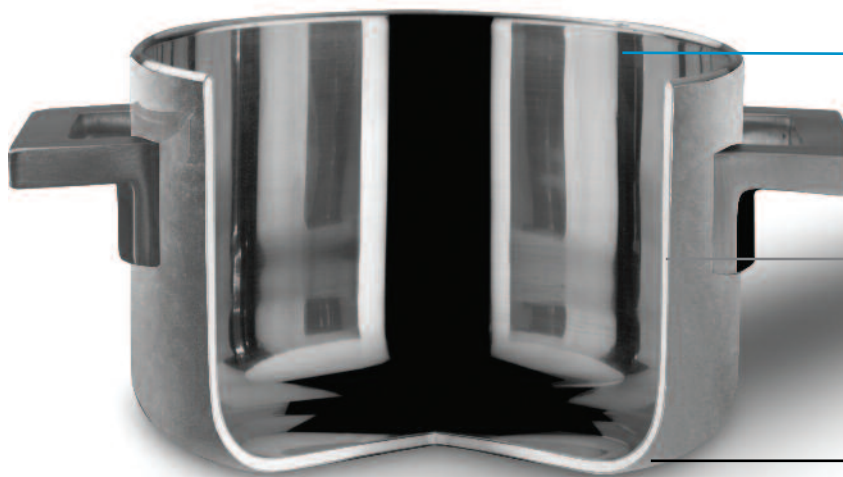

Strato interno - Inner layer

Acciaio Inossidabile 18/10 - Il materiale in assoluto più igienico e più facile da pulire
 Stainless Steel 18/10 - The material even more hygienic easier to clean

Strato centrale - Middle layer

Cuore in alluminio - Il materiale leggero, non soggetto a corrosione ed atossico
 Aluminum core - The lightweight, non-corrosive and non-toxic

Strato esterno - Outer layer

Acciaio speciale per induzione
 Special steel for induction



2831
 Risottiera e tegame per arrosti e brasati in **Trimetallo** con interno in acciaio inossidabile 18/10 senza rivestimento
Tri-ply Low casserole for risotto and stews.

Ø cm. 24 - Lt. 3,0 Ø 9 1/2" - Qt. 3 1/6
 Ø cm. 28 - Lt. 4,0 Ø 11" - Qt. 4 1/5



2821
 Sauteuse per condimenti e salse in **Trimetallo** con interno in acciaio inossidabile 18/10 senza rivestimento
Tri-ply Casserole for serving sauces, soups and side dishes.

Ø cm. 18 - Lt. 2,0 Ø 7" - Qt. 2 1/9
 Ø cm. 20 - Lt. 3,0 Ø 7 7/8" - Qt. 3 1/6
 Ø cm. 22 - Lt. 3,5 Ø 8 2/3" - Qt. 3 2/3
 Ø cm. 24 - Lt. 5,0 Ø 9 1/2" - Qt. 5 1/3



2801
 Pentola in **Trimetallo** con interno in acciaio inossidabile 18/10 senza rivestimento
Tri-ply Deep pot

Ø cm. 20 - Lt. 3,5 Ø 7 7/8" - Qt. 3 2/3
 Ø cm. 22 - Lt. 5,0 Ø 8 2/3" - Qt. 5 1/3
 Ø cm. 24 - Lt. 6,5 Ø 9 1/2" - Qt. 6 1/8



2811 **2821**
 Mini casseruole per soufflé, condimenti e salse in **Trimetallo** con interno in acciaio inossidabile 18/10 senza rivestimento
Tri-ply Mini casseroles for soufflé, condiments and sauces

Ø cm. 9 - Lt. 0,25 Ø cm. 12 - Lt. 0,6
 Ø 3 1/2" - Qt. 1/4 Ø 4 2/3" - Qt. 2 1/9
 Ø cm. 14 - Lt. 1,0
 Ø 5 1/2" - Qt. 1
 Ø cm. 16 - Lt. 2,0
 Ø 6 1/3" - Qt. 2 1/9



2841
Padella in **Trimetallo**
Tri-ply Frying pan
Poêle à frire
Bratpfanne
Sartén

Ø cm. 22	Ø 8 ² / ₃ "
Ø cm. 26	Ø 10 ¹ / ₄ "
Ø cm. 30	Ø 11 ³ / ₄ "

Acciaio Inossidabile 18/10, cuore in alluminio, esterno in acciaio per induzione
 Superficie esterna ed interna lucidate a specchio
 Maniglie con rivetti in acciaio inossidabile 18/10, a tenuta rinforzata
 Il calore si distribuisce uniformemente su tutta la superficie della pentola
 Maggiore controllo della temperatura di cottura
 Notevole risparmio di energia e tempo
 Minor alterazione delle vitamine e proteine durante la cottura

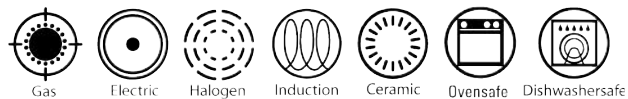

18/10 Stainless Steel, aluminum core, Induction Steel outside
 Mirror polished surfaces, outside and inside
 Handles with strongly fixed 18/10 Stainless Steel rivets,
 The heat is distributed evenly over the surface of the pot
 Greater control of cooking temperature
 Considerable saving of energy and time
 Minor alteration of vitamins and proteins during cooking



Strato interno - Inner layer

Acciaio Inossidabile 18/10 - Il materiale in assoluto più igienico e più facile da pulire
 Stainless Steel 18/10 - The material even more hygienic easier to clean

Strato centrale - Middle layer

Cuore in alluminio - Il materiale leggero, non soggetto a corrosione ed atossico
 Aluminum core - The lightweight, non-corrosive and non-toxic

Strato esterno - Outer layer

Acciaio speciale per induzione
 Special steel for induction



18310

Risottiera e tegame per arrosti e brasati in **Trimetallo** con interno in acciaio inossidabile 18/10 senza rivestimento
Tri-ply Low casserole for risotto and stews.

Ø cm. 24 - Lt. 3,0
 Ø cm. 28 - Lt. 4,0

Ø 9 1/2" - Qt. 3 1/6
 Ø 11" - Qt. 4 1/5



18210

Sauteuse per condimenti e salse in **Trimetallo** con interno in acciaio inossidabile 18/10 senza rivestimento
Tri-ply Casserole for serving sauces, soups and side dishes.

Ø cm. 18 - Lt. 2,0
 Ø cm. 20 - Lt. 3,0
 Ø cm. 22 - Lt. 3,5
 Ø cm. 24 - Lt. 5,0

Ø 7" - Qt. 2 1/9
 Ø 7 1/8" - Qt. 3 1/6
 Ø 8 2/3" - Qt. 3 2/3
 Ø 9 1/2" - Qt. 5 1/3



18010

Pentola in **Trimetallo** con interno in acciaio inossidabile 18/10 senza rivestimento
Tri-ply Deep pot

Ø cm. 20 - Lt. 3,5
 Ø cm. 22 - Lt. 5,0
 Ø cm. 24 - Lt. 6,5

Ø 7 7/8" - Qt. 3 2/3
 Ø 8 2/3" - Qt. 5 1/3
 Ø 9 1/2" - Qt. 6 1/8



18110

Mini casseruole per soufflé, condimenti e salse in **Trimetallo** con interno in acciaio inossidabile 18/10 senza rivestimento
Tri-ply Mini casseroles for soufflé, condiments and sauces

Ø cm. 9 - Lt. 0,25
 Ø 3 1/2" - Qt. 1/4
 Ø cm. 14 - Lt. 1,0
 Ø 5 1/2" - Qt. 1
 Ø cm. 16 - Lt. 2,0
 Ø 6 1/3" - Qt. 2 1/9



18210

Mini casseruole per soufflé, condimenti e salse in **Trimetallo** con interno in acciaio inossidabile 18/10 senza rivestimento
Tri-ply Mini casseroles for soufflé, condiments and sauces

Ø cm. 12 - Lt. 0,6
 Ø 4 2/3" - Qt. 2 1/9



18410
Padella in **Trimetallo**
Tri-ply Frying pan
Poêle à frire
Bratpfanne
Sartén

Ø cm. 22	Ø 8 ² / ₃ "
Ø cm. 26	Ø 10 ¹ / ₄ "
Ø cm. 30	Ø 11 ³ / ₄ "





Rame, cuore in alluminio, interno in acciaio inossidabile 18/10 - Superficie esterna ed interna lucidate a specchio - Maniglie con rivetti in acciaio inossidabile 18/10, a tenuta rinforzata

Il calore si distribuisce uniformemente su tutta la superficie della pentola - Maggiore controllo della temperatura di cottura - Notevole risparmio di energia e tempo - Minor alterazione delle vitamine e proteine durante la cottura

Copper, aluminum core, 18/10 Stainless Steel inside - Mirror polished surfaces, outside and inside - Handles with strongly fixed 18/10 Stainless Steel rivets.

The heat is distributed evenly over the surface of the pot - Greater control of cooking temperature - Considerable saving of energy and time - Minor alteration of vitamins and proteins during cooking.

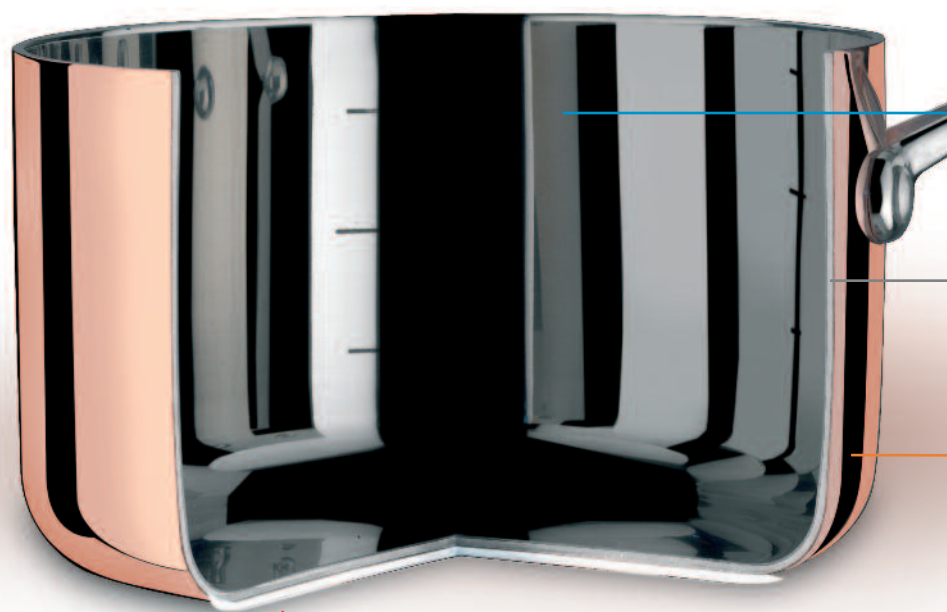
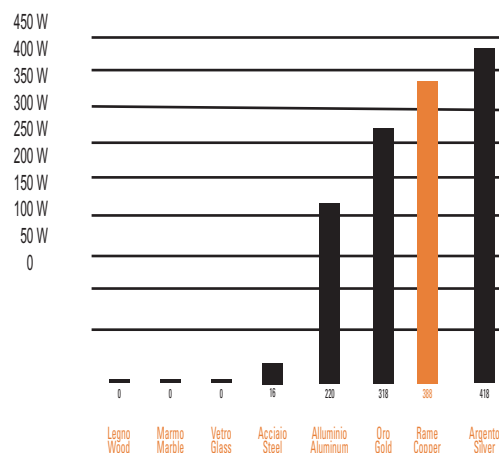

Strato interno - Inner layer

Acciaio Inossidabile 18/10 - Il materiale in assoluto più igienico e più facile da pulire
Stainless Steel 18/10 - The material even more hygienic easier to clean

Strato centrale - Middle layer

Cuore in alluminio - Il materiale leggero, non soggetto a corrosione ed atossico
Aluminum core - The lightweight, non-corrosive and non-toxic

Strato esterno - Outer layer

Rame - Il materiale a più alta conduttività dopo l'argento
Copper - The material with higher conductivity after silver

Fondo speciale - Special bottom
Adatto all'induzione - Suitable for inductions stoves too.

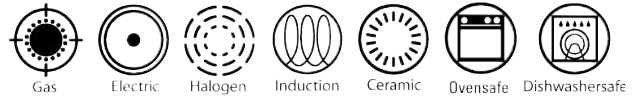

1231

Risottiera e tegame per arrosti e brasati in **Trimetallo** con interno in acciaio inossidabile 18/10 senza rivestimento.
 Low casserole for risotto and stews. **Tri-ply** with 18/10 inside, aluminum and copper.
 Ø cm. 28 - Lt. 4,5 Ø 11" - Qt. 4 1/2



1211

Sauteuse per condimenti e salse in **Trimetallo** con interno in acciaio inossidabile 18/10 senza rivestimento.
Tri-ply saucepan with 18/10 inside, aluminum and copper.
 Ø cm. 16 - Lt. 1,9 Ø 6 1/3" - Qt. 1



1241

Padella in **Trimetallo** con interno in acciaio inossidabile 18/10 senza rivestimento
Tri-ply frying pan with 18/10 inside, aluminum and copper.
 Ø cm. 26 - Lt. 2,9 Ø 10 1/4" - Qt. 2 1/8



1201

Pentola in **Trimetallo** con interno in acciaio inossidabile 18/10 senza rivestimento
Tri-ply deep pot with 18/10 inside, aluminum and copper.
 Ø cm. 20 - Lt. 4,0 Ø 7 7/8" - Qt. 4 1/5
 Ø cm. 24 - Lt. 7,7 Ø 9 1/2" - Qt. 8 1/8



1221

Casseruola per soufflé, condimenti e salse in **Trimetallo** con interno in acciaio inossidabile 18/10 senza rivestimento
Tri-ply Saucepan for soufflé, seasonings and sauces with 18/10 inside, aluminum and copper.
 Ø cm. 20 - Lt. 2,9 Ø 7 7/8" - Qt. 3
 Ø cm. 24 - Lt. 3,5 Ø 9 1/2" - Qt. 3 2/3



2179
Padella antiaderente
Non-stick frying pan
Poêle à frire anti-adhérent
Antihaft Bratpfanne
Sartén antiadherente

Ø cm. 20	Ø 7 ¹ / ₈ "
Ø cm. 24	Ø 9 ¹ / ₂ "
Ø cm. 28	Ø 11"
Ø cm. 32	Ø 12 ⁴ / ₅ "

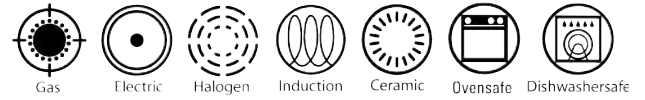

Strato interno - Inner layer

Rivestimento triplo strato antiaderente di ultima generazione, antimacchia. Rivestimento resistente agli utensili metallici non taglienti.

The last generation triple non-stick layer is so strong, that allow you to cook with non-sharp metal utensils.

Strato esterno - Outer layer

Triplo fondo incapsulato per cottura ad induzione

Sandwiched thermoradiant bottom for induction cooking

Acciaio Inossidabile 18/10 - Fondo termodiffusore incapsulato (Acciaio Inossidabile 18/10 - Alluminio - Acciaio per induzione). Bordo antigoccia rinforzato - Lavabile in lavastoviglie senza che ne venga compromessa l'antiaderenza. Le eccezionali proprietà antiaderenti permettono una cucina completamente priva di grassi, per uno stile di vita attivo e salutare. Rispetto della natura e del pianeta, grazie alla totale assenza di PFOA.

18/10 Stainless Steel - Sandwiched thermoradiant bottom (18/10 Stainless Steel - Aluminum - Steel for Induction). Reinforced non-drip edge. The non-stick coating is not compromised during the washing cycle. The outstanding non-stick properties also allow a fully fatfree cuisine, for an active and healthy life. Thanks to the total absence of PFOA, the collection respects the nature.



2180

Bistecchiera ad alto spessore per alte temperature con rivestimento antiaderente, PFOA Free, per induzione, antimacchia, antigraffio.

High gauge steak pan for high heat with "Eterna" non-stick coating, PFOA free, stain resistant and scratch resistant.

cm. 28 x 28 11" x 11"



2131

Risottiera e tegame per arrostiti e brasati con coperchio per alte temperature con rivestimento antiaderente, PFOA Free, per induzione, antimacchia, antigraffio.

Low casserole for risotto and stews with "Eterna" non-stick coating, PFOA free, stain resistant and scratch resistant.

Ø cm. 32 - Lt. 5,0 Ø 12 3/5" - Qt. 5 1/7



2178

Wok saltapasta con coperchio per alte temperature con rivestimento antiaderente, PFOA Free, per induzione, antimacchia, antigraffio.

Wok with lid for high heat with "Eterna" non-stick coating, PFOA Free, for induction, stain resistant and scratch resistant.

Ø cm. 28 - Lt. 3,0 Ø 11 1/4" - Qt. 3 1/2

GOURMET



Gas



Electric



Halogen



Induction



Ceramic



Ovensafe



Dishwashersafe



1501
Pentola alta con coperchio
Deep pot with lid

Ø cm. 20 - Lt. 4,2 Ø 7 7/8" - Qt. 4 2/7
Ø cm. 22 - Lt. 4,8 Ø 8 2/3" - Qt. 5
Ø cm. 24 - Lt. 5,4 Ø 9 1/2" - Qt. 5 2/3



1511
Casseruola 1 manico con coperchio
Deep casserole 1 handle with lid

Ø cm. 16 - Lt. 1,5 Ø 6 1/3" - Qt. 1 2/5



1521
Casseruola fonda 2 manici con coperchio
Deep casserole 2 handles with lid

Ø cm. 20 - Lt. 2,9 Ø 7 7/8" - Qt. 3
Ø cm. 22 - Lt. 3,3 Ø 8 2/3" - Qt. 3 1/2
Ø cm. 24 - Lt. 3,8 Ø 9 1/2" - Qt. 4



1531
Tegame 2 manici con coperchio
Frying pan 2 handles with lid

Ø cm. 26 - Lt. 3,3 Ø 10 1/4" - Qt. 3 1/2
Ø cm. 30 - Lt. 5,6 Ø 11 4/5" - Qt. 5 7/8



1500/08

Batteria da cucina 8 pezzi
8 pcs. Kitchen set
Composta da - Composed by:

1 Pentola alta - Deep pot	Ø cm. 20	Ø 7 7/8"
1 Casseruola 1 manico	Ø cm. 16	Ø 6 1/3"
1 Deep casserole 1 handle		
1 Casseruola 2 manici	Ø cm. 20	Ø 7 7/8"
1 Deep casserole 2 handles		
1 Tegame 2 manici	Ø cm. 26	Ø 10 1/4"
1 Frying pan 2 handles		
2 Coperchi - Lids	Ø cm. 20	Ø 7 7/8"
1 Coperchio - Lid	Ø cm. 16	Ø 6 1/3"
1 Coperchio - Lid	Ø cm. 26	Ø 10 1/4"



1500/14

Batteria da cucina 14 pezzi
14 pcs. Kitchen set
Composta da - Composed by:

1 Pentola alta - Deep pot	Ø cm. 20	Ø 7 7/8"
1 Casseruola 1 manico	Ø cm. 16	Ø 6 1/3"
1 Deep casserole 1 handle		
1 Casseruola 2 manici	Ø cm. 20	Ø 7 7/8"
1 Deep casserole 2 handles		
1 Tegame 2 manici	Ø cm. 26	Ø 10 1/4"
1 Frying pan 2 handles		
1 Spghettiera	Ø cm. 22	Ø 8 2/3"
1 Pasta pot (3pcs)		
1 Cuociverdura	Ø cm. 22	Ø 8 2/3"
1 Vegetable steamer (3pcs)		
1 Coperchio - Lid	Ø cm. 16	Ø 6 1/3"
2 Coperchi - Lids	Ø cm. 20	Ø 7 7/8"
1 Coperchio - Lid	Ø cm. 26	Ø 10 1/4"





1579
Padella antiaderente
Non-stick frying pan
Poêle à frirre anti-adhérent
Antihaft Bratpfanne
Sartén antiadherente
Ø cm. 22 Ø 8 ¹/₃"
Ø cm. 26 Ø 10 ¹/₄"
Ø cm. 30 Ø 11 ¹/₅"

GOURMET

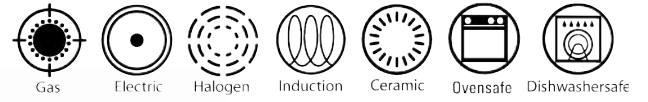

1578
Wok antiaderente con coperchio
Non-stick wok with lid

Ø cm. 30 - Lt. 5,0 Ø 11 3/4" - Qt. 5 1/4



1581
Bollilatte
Milk boiler

cm. 12 - Lt. 1,2

Ø 4 3/4" - Qt. 1 1/2



1591
Inserto cuocipasta 2 scomparti
Pasta pot insert 2 compt.

Per pentola Ø cm. 24
For pot Ø 9 1/2"



883
Colapasta
Colander

cm. 33 13"



1571
Cuocipasta con coperchio
Pasta pot with lid

Ø cm. 22 - Lt. 6,6

Ø 8 2/3" - Qt. 7



1572
Cuociverdura con coperchio
Vegetable steamer with lid

Ø cm. 22 - Lt. 4,3

Ø 8 2/3" - Qt. 4 1/2

Spa & Wellness



- Infrangibile
- Adatto alla lavastoviglie
- Adatto al forno a microonde
- Ideale per:
- Discoteche
- Yacht e navi da crociera
- Cliniche
- Case di riposo per anziani
- Asili
- Ideale per tutti i luoghi dove i clienti possono accedere a piedi nudi:
- Piscine
- Spiagge
- Prati
- Centri di benessere
- Impianti sportivi
- Tonalità diverse disponibili a richiesta
- Possono essere personalizzati con logo, anche a più colori

- Unbreakable
- Dishwasher Safe
- Microwave Safe
- Ideal for:
- Night Clubs
- Yachts and Cruise Ships
- Hospitals and Medical Clinics
- Rest Homes
- Schools
- Perfect for Barefoot Environments:
- Swimming Pools
- Beaches
- Lawns
- Wellness Centers
- Fitness Centers
- Available in additional colors.
- Imprinting and logos available. Multicolor printing available.

- Incassable
- Utilisable au laves-vaisselles
- Utilisable au Four à micro-ondes
- Idéal pour :
- Discothèques
- Yacht et bateaux de croisière
- Cliniques
- Maisons de repos
- Crèches
- Idéal pour tous les lieux où les clients peuvent accéder à pied nus :
- Piscines
- Plages
- Jardin
- Centre de bien-être

- Installations sportives
- Tonalités différentes disponibles sur demande
Ils peuvent être personnalisés avec logo, multicouleurs, gravées ou lazer

- Unzerbrechlich
- Spülmaschinenfest
- Microwellenfest
- Daher bestens geeignet zum Gebrauch:
- in Cocktailbars & Night Clubs
- für Yachten und Kreuzfahrtschiffe
- in Kliniken und Heimen
- in Badezimmern
- für Schulen und Kindergärten

Auch aufgrund der Bruchsicherheit perfekt einzusetzen an Orten, die barfuß betreten werden:

- Schwimmbäder und Poolbereiche
- Strände und Strandbars
- Rasenflächen
- Wellnesscenter
- Fitnesscenter
- Alle Produkte sind auch in zusätzlichen, weiteren Farben erhältlich.
- Alle Produkte können auch mit Logos und Beschriftung individualisiert werden.
- Dabei ist auch mehrfarbiger Druck möglich.

- Irrompible
- Apto para lavavajillas
- Apto para microondas
- Ideal para:
- Discotecas
- Yates y barcos de crucero
- Clinicas
- Residencias de ancianos
- Asilos
- Ideal para todos los lugares donde los clientes pueden ir descalzos:
- Piscinas
- Playas
- Praderas
- Centros de bienestar
- Centros deportivos
- Tonos diversos disponibles por encargo
- Se pueden personalizar con logo, incluso en varios colores.



588



Bicchiere
Glass
Gobelet
Glas
Vaso

H cm 10
cl. 33
H 3⁷/₈"
oz. 11 ¹/₈

591



Bicchiere
Glass
Gobelet
Glas
Vaso

H cm 13
cl. 45
H 5"
oz 15 ¹/₄

554



Fondo
Bowl
Bol
Obstschale oval
Cuenco

Ø cm. 18 Ø 7"

553

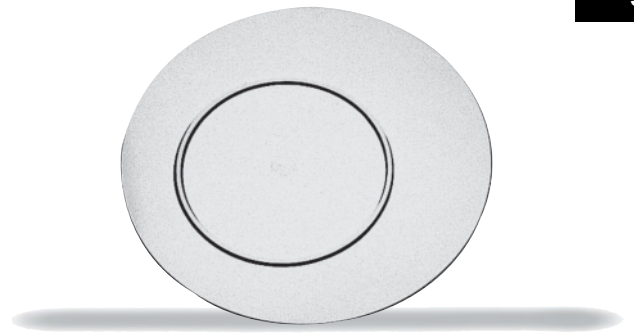

Piano
Tray
Plateau
Tablett oval
Bandeja

Ø cm. 27 Ø 10 ¹/₂"

555



Piano per buffet
Tray for buffet
Plateau pour buffet
Buffettablett
Bandeja para buffet

Ø cm. 27 Ø 10 ¹/₂"

536



Coppa per gelato
Ice cream cup
Coupe à glace
Eisbecher
Copa helado

H cm 12 H 4 3/4"
cl. 27 oz 9 1/8

535



Coppa Martini
Martini glass
Coupe à Martini
Martini glas
Vaso para Martini

H cm. 19 H 7 1/2"
cl 27 oz 9 1/8

534



Bicchiere per birra
Beer glass
Gobelet pour birre
Bierbecher
Vaso para cerveza

H cm. 17,5 H 6 7/8"
cl 45 oz 15 1/8

533



Bicchiere per vino
Beverage glass
Gobelet pour vin
Weinbecher
Vaso para vino

H cm. 24,5 H 9 1/3"
cl 45 oz 15 1/8

527



Bicchiere da whisky
Whisky glass
Gobelet pour whisky
Whisky Becher
Vaso para whisky

cl. 15
oz. 5 1/8

531



Bicchiere da liqueure
Liquor glass
Gobelet pour alcool
Schnapsbecher
Vaso para alcohol

cl. 9
oz. 3

543



Bicchiere per champagne
Champagne glass
Gobelet pour champagne
Champagnerglas
Vaso para champany

H cm. 22,7 H 9"
cl. 15 oz. 5 1/8

589



Ciotola tonda
Round bowl
Bol ronde
Früchtekorb, rund
Cuenco redondo

Ø cm. 12 Ø 4 3/4"
H cm. 7,4 H 2 7/8"
cl. 40 oz. 13 1/2

605



Set impilabile di 3 coppette tonde
Stackable set of 3 round bowls
Set empilable de 3 bols ronde
Stapelbarer Relish-Pickles-Gestell, rund
Set impilable de 3 cuencos redondos

cl. 40 (x 3) oz. 13 1/2 (x 3)

589



Ciotola tonda
Round bowl
Bol ronde
Früchtekorb rund
Cuenco redondo

Ø cm. 22 Ø 8 1/2"
H cm. 14 H 5 1/2"
cl. 220 oz. 74 3/8

589+599



Ø cm. 28 Ø 11"
H cm. 17,3 H 6 5/8"
lt. 6,03 oz. 202 1/2

589



Ciotola tonda
Round bowl
Bol ronde
Früchtekorb rund
Cuenco redondo

550



Mug

H cm 10
cl. 33
H 3 7/8"
oz. 11 1/8

552



Piattino per mug e bicchieri (Art. 550,588,591) Ø cm. 13,2 Ø 5 1/4"
Mug coaster (Art. 550,588,591)
Dessous de verre (Art. 550,588,591)
Gläseruntersatz (Art. 550,588,591)
Posavasos por mug (Art. 550,588,591)

592



Tazzina da caffè con piattino
Express coffee cup and saucer
Tasse de moka avec soucoupe
Mokka Tasse mit Untertasse
Taza de moka con platillo

cl 9 oz. 3

593



Tazza da tè con piattino
Tea cup and saucer
Tasse de thé avec soucoupe
Tee Tasse mit Untertasse
Taza de tè con platillo

cl 15 oz 5 1/8

590



Ciotola quadra
Square bowl
Bol carrè
Obstschale viereckig
Cuenco cuadrado

cm. 10 x 10 3 7/8" x 3 7/8"
cl. 27 oz. 9 1/8

606



Set impilabile di 3 coppette quadre
Stackable set of 3 square bowls
Set empilable de 3 bols carrè
Stapelbarer Relish-Pickles-Gestell ,
quadratisch
Set impilable de 3 cuencos cuadrados

cl. 27 (x 3) oz. 9 1/8 (x 3)



A Ambra
Amber
Ambre
Amber
Ambar



G Granato
Garnet
Grenat
Granat
Granate



S Smeraldo
Emerald
Émeraude
Smaragd
Esmeralda

Tutti gli articoli da pagina 338 a pagina 341 sono disponibili in 8 colori, tranne il nero. Gli articoli 533, 534, 535, 536 e 543 sono disponibili solo in 3 colori: bianco, nero e trasparente.

All the items from page 338 to page 341 are available in 8 colors, black excluded. The items 533, 534, 535, 536 and 543 are available in 3 colors only: white, black and transparent.

Tous les articles de la page 338 à la page 341 sont disponibles en 8 couleurs, noir exclu. Les articles 533, 534, 535, 536 et 543 sont uniquement disponibles en 3 couleurs: porcelain, noir et transparent.



Z Zaffiro
Sapphyre
Saphir
Saphir
Zaffiro

Alle Polikarbonat-Produkte von Seite 338 bis Seite 341 sind in 8 Farben erhältlich, außer Schwarz. Die Artikel 533, 534, 535, 536 und 543 sind nur in 3 Farben erhältlich: Weiß, Schwarz und Transparent.

Todos los artículos desde la página 338 hasta la página 341 están disponibles en 8 colores, excepto el negro. Los artículos 533, 534, 535, 536 y 543 solo están disponibles en 3 colores: porcelana, negro y transparente.



M Ametista
Amethyst
Amethyste
Amethyst
Amatista



W Trasparente
Transparent
Glace
Transparent
Vidrio



O Onice
Onyx
Onyx
Onyx
Onice



P Porcellana
White
Porcelain
Weiss
Porcelana



N Nero
Black
Noir
Schwarz
Negro



886



Secchiello per ghiaccio
Ice bucket
Seau à glaçons
Eisgefäß
Cubitera hielo

Ø cm. 15 Ø 5 7/8"
H cm. 15 H 5 7/8"
cl. 150 oz. 50 3/4

888



Secchiello per spumante
Sparkling wine cooler
Seau à vin/glace
Wein- und Sektkühler
Cubo para champany

Ø cm. 22 Ø 8 7/8"
H cm. 22 H 8 7/8"
lt. 5 gal. 1 1/4

891



Bicchiere
Glass
Gobelet
Glas
Vaso

H cm. 13 H 5"
cl. 33 11 1/8 oz

892



Bicchiere
Glass
Gobelet
Glas
Vaso

H cm. 10 H 4"
cl. 25 8 7/8 oz

517

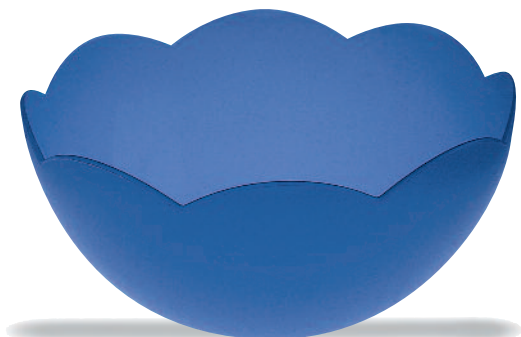

Ciotola
Bowl
Bol
Obstschale
Cuenco

Ø cm. 10 Ø 3 7/8"
cl. 30 oz. 10 1/8
Ø cm. 15 Ø 5 7/8"
cl. 60 oz. 20 1/4
Ø cm. 22 Ø 8 7/8"
cl. 200 oz. 67 7/8
Ø cm. 28 Ø 11"
lt 4 gal. 1

099

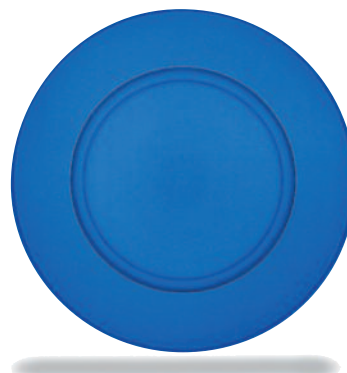

Sottopiatto
Charger
Assiette de bienvenue
Platzteller
Bajo plato

CARAMELLA Ø cm. 32 Ø 12 7/8"
" "
" "
" "

892



W Ghiaccio
Ice
Glace
Eis
Hielo



O Arancio
Orange
Orange
Orange
Naranja



G Limone
Lemon
Jaune
Zitrone
Amarillo



E Verde acido
Acid green
Vert acide
Azid Grün
Pistacho



B Anice
Anis
Bleu
Blau
Azul



U Luce di Wood
Wood light
Lumière de Wood
Schwarzlicht
Luz de Wood
Solo art. 891 - 892
Only for art. 891 - 892
Seulement pour art. 891 - 892
Nur für Art. 891 - 892
Solo para art. 891 - 892

Tutti gli articoli di pagina 340 sono disponibili in 5 colori

All the items of page 340 are available in 5 colors

Toutes les articles de page 340 sont disponibles en 5 couleurs

Alle Produkte von Seite 340 sind in 5 Farben bzw. Ausführungen erhältlich

Todos los artículos de pagina 340 son disponibles en 5 colores

Trolleys



- Carrelli multifunzionali
Vasta gamma di accessori disponibili
- Molteplici finiture
- Ruote speciali a grandezza maggiorata, fascia in gomma antistatica e antitraccia
- Angolari rinforzati
- Logo a richiesta

- Multifunctional trolleys
A complete range of optional accessories
- Numerous customization choices
- The oversized wheels are anti-static, won't leave marks.
- Reinforced legs
- Company logo on demand

- Chariots multifonctions
Complète dotation d'accessoires disponibles
- Variété de finitions
- Roulettes surdimensionnées spéciales, avec bande en caoutchouc synthétique conducteur antitrace
- Arêtes renforcées
- Logo à la demande

- Multifunktioneller Trolley
Grosse Auswahl von optionalem Zubehör
- Grosse Auswahl von Oberflächen- Variationen und Lack-Farben
- Besonders grossdimensionierte Rollen mit antistatischen Gummireifen, die keinen Abrieb hinterlassen
- Spezialverstärkte Beine
- Ihr Firmen-Logo auf Wunsch als Option

- Carros multifunción
Vasta gama de accesorios opcionales
- Múltiples acabados
- Ruedas especiales de mayor tamaño, con cinta de goma antistática y antihuellas
- Angulares reforzados
- Logo a solicitud

MEPRÁ
S.p.A.

TROLLEYS

LONDON



Gueridon

H cm 80
cm 80 x 40

H 31 1/2"
31 1/2" x 15 3/4"

DELUXE

031



032



Massello con angolari in acciaio inossidabile 18/10
Solid wood with 18/10 Stainless Steel legs
Massif avec arêtes en inox 18/10
Massivholz, Beine mit Edelstahl Rostfrei 18/10 Profi-
len verblendet
Tablero con angulares en acero inox 18/10

VIP

036



037



Massello con angolari in massello
Trolley and solid wood legs
Panneaux massif
Trolley und Beine komplett aus Massivholz
Tablero macizo con angulares macizos

COLORI

		031 036	032 037	
		Noce Walnut Noyer Walnuss Nuez	Wengè	

TROLLEYS

HAVANA



H cm 87
cm 50 x 50

H 34 ¹/₄"
19 ³/₄" x 19 ³/₄"

DELUXE

121



122



Massello con angolari in acciaio inossidabile 18/10
Solid wood with 18/10 Stainless Steel legs
Massif avec angle en inox 18/10
Massivholz, Beine mit Edelstahl Rostfrei 18/10
Profilen verblendet
Tablero con angulares en acero inox 18/10

VIP

126



127



Massello con angolari in massello
Trolley and solid wood legs
Panneaux massif avec angles et hanches massif
Trolley und Beine komplett aus Massivholz
Tablero macizo con angulares macizos

COLORI

		121 126	122 127	
		Noce Walnut Noyer Walnuss Nuez	Wengè	

TROLLEYS

NIZZA



H cm 87 H 34 1/4"
cm 50 x 50 19 3/4" x 19 3/4"

DELUXE

091



092

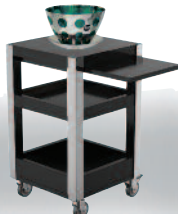

Massello con angolari e maniglioni in acciaio inossidabile 18/10
Solid wood with 18/10 Stainless Steel handles and legs
Massif avec arêtes et hanches en inox 18/10
Massivholz, Beine mit Edelstahl Rostfrei 18/10 Profilen
verblendet, Griffe 18/10
Tablero con angulares y asas en acero inox 18/10

COLORI

Questo carrello comprende un inserto avvitato sul piano ed il relativo secchiello per champagne, art. 599 + art. 589 (colore a vostra scelta).

This trolley includes a screwed insert onto the top and the relative champagne cooler, art. 599 + art. 589 (color to your choice).

Ce chariot comprend un supplément vissé sur l'étagère et le relatif seau à champagne, art. 599 + art. 589 (couleur à votre choix).

Dieser Trolley einschl. fixiertem Halter für Weinkühler, art. 599 einschl. Weinkühler mit Einsatz, art. 589 (Farben zu Ihrer Wahl).

Esto carro comprende un legajo atornillado sobre el plan y el relativo cubo por champán, art. 599 + art. 589 (color a vuestra elección).

		091	092	
		Noce Walnut Noyer Walnuss Nuez	Wengè	

TROLLEYS

LAS VEGAS



H cm 83 H 32 3/4"
cm 104 x 57 41" x 22 1/2"

DELUXE

051



052



Massello con angolari e maniglioni in acciaio inossidabile 18/10
Solid wood with 18/10 Stainless Steel handles and legs
Massif avec arêtes et hanches en inox 18/10
Massivholz, Beine mit Edelstahl Rostfrei 18/10 Profilen
verblendet, Griffe 18/10
Tablero con angulares y asas en acero inox 18/10

VIP

056



057



Massello con angolari e maniglioni in massello
Trolley and solid wood handles and legs
Panneaux massif avec angles et hanches massif
Trolley und Beine komplett aus Massivholz
Tablero macizo con angulares y asas macizas

COLORI

		051 056	052 057	
		Noce Walnut Noyer Walnuss Nuez	Wengè	

TROLLEYS

DALLAS



H cm 83 H 32 3/4"
cm 104 x 57 41" x 22 1/2"

DELUXE

041



042



Massello con angolari e maniglioni in acciaio inossidabile 18/10
Solid wood with 18/10 Stainless Steel handles and legs
Massif avec arêtes et hanches en inox 18/10
Massivholz, Beine mit Edelstahl Rostfrei 18/10 Profilen
verblendet, Griffe 18/10
Tablero con angulares y asas en acero inox 18/10

VIP

046



047



Massello con angolari e maniglioni in massello
Trolley and solid wood handles and legs
Panneaux massif avec angles et hanches massif
Trolley und Beine komplett aus Massivholz
Tablero macizo con angulares y asas macizas

COLORI

		041 046	042 047	
		Noce Walnut Noyer Walnuss Nuez	Wengè	

TROLLEYS

MIAMI



H cm 82
cm 80 x 91

H 32 1/4"
31 1/2" x 35 7/8"

DELUXE

106

107



Massello con angolari in acciaio inossidabile 18/10
Solid wood with 18/10 Stainless Steel legs
Massif avec angle en inox 18/10
Massivholz, Beine mit Edelstahl Rostfrei 18/10
Profilen verblendet
Tablero con angulares en acero inox 18/10

VIP

COLORI

101

102



Massello con angolari in massello
Trolley and solid wood legs
Panneaux massif avec angles et hanches massif
Trolley und Beine komplett aus Massivholz
Tablero macizo con angulares macizos

		101 106	102 107	
		Noce Walnut Noyer Walnuss Nuez	Wengè	

TROLLEYS



MANIGLIA

Maniglione a scomparsa, regolabile in altezza, per la corretta postura della schiena durante la movimentazione.

HANDLE

The foldaway handle can be ergonomically adjusted to the height of the user during transport.

POIGNÉE

Poignée disparible, réglable en hauteur, pour la posture correcte du dos pendant le mouvements.

SCHIEBEGRIFF

Der einklappbare Schiebegriff kann ergonomisch exakt auf die passende Höhe des Fahrers eingestellt werden, die er zum jeweiligen Transport benötigt.

AGARRADOR

Agarrador abatible, ajustable en altura, para una correcta postura de la espalda durante el uso.



HOT BOX

Contenitore Hot Box elettrico a 4 scomparti, con termostato regolabile fino a 90° C. Diametro massimo dei piatti inseribili: 31 cm.

HOT BOX

Electric Hot Box compartment, 4 compartments with adjustable thermostat up to 194° F. Maximum inner dimension:: 12 1/4".

HOT BOX

Récipient Hot Box électrique aux 4 compartiments, avec thermostat réglable jusqu'à 90° C. Maximum diamètre des plats insertables: 31 cms.

HOT BOX

Elektrisch betriebene HOT BOX mit 4 Abteilungen, mit jeweils Nutzfläche bis zu 31 cm Durchmesser. Die HOT BOX ist ausgestattet mit einem regelbaren Thermostat bis zu 90° C.

HOT BOX

Contenedor eléctrico de 4 compartimentos, con termostato ajustable a 90° C. Diámetro máximo de los platos insertables: 31 cm.



PIANO SUPERIORE ESTENSIBILE

Piano superiore estensibile "a tavolino", massima estensione cm. 92 x 80

EXTENDABLE UPPER SURFACE

Upper surface can be extended up to 36 1/4" x 31 1/2"

PLAT SUPÉRIEUR EXTENSIBLE

Plat supérieur extensible, meilleure étendue cm. 92 x 80.

AUSKLAPPBARE TISCHFLÄCHE

Die Tischfläche kann durch Ausklappen vergrößert werden auf das Mass von 92 x 80 cm.

PLANO SUPERIOR EXTENSIBLE

Plano superior extensible, medida total extendida 92 x 80 cm.

TROLLEYS



SCOMPARTI
Scomparti portabottiglie e bicchieri.

COMPARTMENTS
Compartments for wine bottles, glasses and stemware are also available.

COMPARTIMENTS
Compartiments portebouteilles et verres.

FÆCHER
Fächer für Weinflaschen, Becher und Stielgläser sind ebenfalls erhältlich.

COMPARTIMENTOS
Compartimentos para botellas y vasos.



CARATTERISTICHE
Alta resistenza, massima maneggevolezza, ruote maggiorate ed anti-statiche.

FEATURES
Durable oversized casters feature maximum maneuverability with non-tracking and non-conductive rubber wheels.

CARACTÉRISTIQUES
Haute résistance, meilleure maniabilité, roues augmentées et anti-statiques.

BESONDERHEITEN
Die groß-dimensionierten, robusten Rollen aus antistatischem Gummi-Material erlauben eine hochgrade Beweglichkeit, selbst bei der Überwindung schwierigster Hindernisse und unterschiedlichsten Bödenbelägen.

CARACTERÍSTICAS
Alta resistencia, máxima manejabilidad, ruedas grandes y antiestáticas.

110



HOT BOX
Contenitore Hot Box elettrico a 4 scomparti, con termostato regolabile fino a 90° C. Diametro massimo dei piatti inseribili: 31 cm.

HOT BOX
Electric Hot Box compartment, 4 compartments with adjustable thermostat up to 194° F. Maximum inner dimension:: 12 1/4".

HOT BOX
Récipient Hot Box électrique aux 4 compartiments, avec thermostat réglable jusqu'à 90° C. Maximum diamètre des plats insertables: 31 cms.

HOT BOX
Elektrisch betriebene HOT BOX mit 4 Abteilungen, mit jeweils Nutzfläche bis zu 31 cm Durchmesser. Die HOT BOX ist ausgestattet mit einem regelbaren Thermostat bis zu 90° C.

HOT BOX
Contenedor eléctrico de 4 compartimentos, con termostato ajustable a 90° C. Diámetro máximo de los platos insertables: 31 cm.

DELUXE - VIP



H cm 5,5

H 2 1/4"

Tutte le versioni Deluxe e Vip hanno la struttura in massello e il piano superiore in massello listellare. Colori optional: faggio, ciliegio, rovere e mogano.

All the wood components for the Deluxe and VIP versions are made from solid wood and the workspace top is made from heavy duty solid Block Wood Available colors: Beachwood, Cherry, Oak and Mahogany

Toutes les versions Deluxe et Vip ont la structure en massif et le plan supérieur en massif. Couleurs facultatif: Hêtre, Cerise, Chêne et Acajou.

Alle Ausführungen für die Deluxe- und VIP-Versionen sind hergestellt aus massivem Holz und die oberen Arbeitsbereiche aus strapazierfähigem, solidem Blockholz
Verfügbare Farben: Buche, Kirsche, Eiche und Mahagoni

Todas las versiones "Deluxe" y "Vip" tienen la estructura en tablero macizo y el plano superior en tablero macizo listelar
Colores disponibles: Haya, Cerezo, Roble y Caoba

CHIC



H cm 4

H 1 5/8"

La versione Chic è interamente in nobilitato laccato lucido, con il piano superiore di alto spessore. The Chic version has an entirely glossy, lacquered, laminate faced finish with a heavy duty workspace top. La version Chic est tout à fait de panneaux noble laqués, avec le plan supérieur de grande épaisseur. Die Chic-Versionen haben ein gänzlich glänzendes, lackiertes, laminiertes Finish mit einem strapazierfähigen oberen Arbeits-Top. La versión "Chic" es enteramente chapado lacado brillo, y con el plano superior de alto espesor.

RICAMBI



cm 15,5 x 7,5
H cm 2

6" x 2 7/8"
H 1"

Piastre eutettiche senza evaporatore, disponibili per tutte le cupole: congelate a -21°C, durano fino a tre ore. Eutectic cooling plates without evaporator are available for all of the roll-top covers. Refrigerated to -5,8°F, they will keep cool for approximately 3 hours.

Bacs eutectiques sans évaporateur, sont disponibles pour toutes les lavallières: réfrigérée à -21° C, ils durent jusqu'à trois heures. Eutektische Kühlplatten ohne Verdampfer, für alle Roll-top Aufsatz erhältlich: vor dem Gebrauch, im Gefrierschrank mit -21°C abkühlen; damit verfügen Sie über 3 Stunden Kühlleistung. Planchas eutecticas sin vaporizador, disponibles para todas las cúpulas: congeláis a -21°C, duran hasta tres horas.

800



H cm 29
cm 11 x 11

H 11 3/8"
4 1/2" x 4 1/2"

Campionario colore per sala esposizione
Colori disponibili: noce, wengè, bianco, nero e oro.

Color Displayer for show room
Available colors: walnut, wenge, gold, black and white.

Couleur Displayer pour show room
Couleurs disponibles: Noyer, Wenge, Blanc, Noir et Or.

Farben Displayer für Show-Room
Erhältliche Farben: Walnuss, Wenge, Weiss, Schwarz und Gold.

Color Displayer para sala de exposiciones
Colores disponibles: Nogal, Wenge, Blanco, Negro y Oro.

ACCESSORI

219

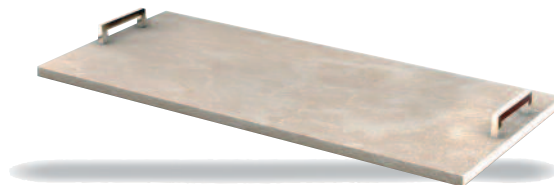

cm 83 x 36
H cm 2

32 3/4" x 14 1/4"
H 1"

Piano in marmo granito, perfettamente levigato e lucidato. Perfectly ground and polished granite marble top surface. Plan en marbre granulé, parfaitement lissé et poli. Polierte Granit-Marmor-Platte mit perfekt glatt geschliffener Oberfläche
Plano en mármol granito, perfectamente pulido.

TROLLEYS

PARIS

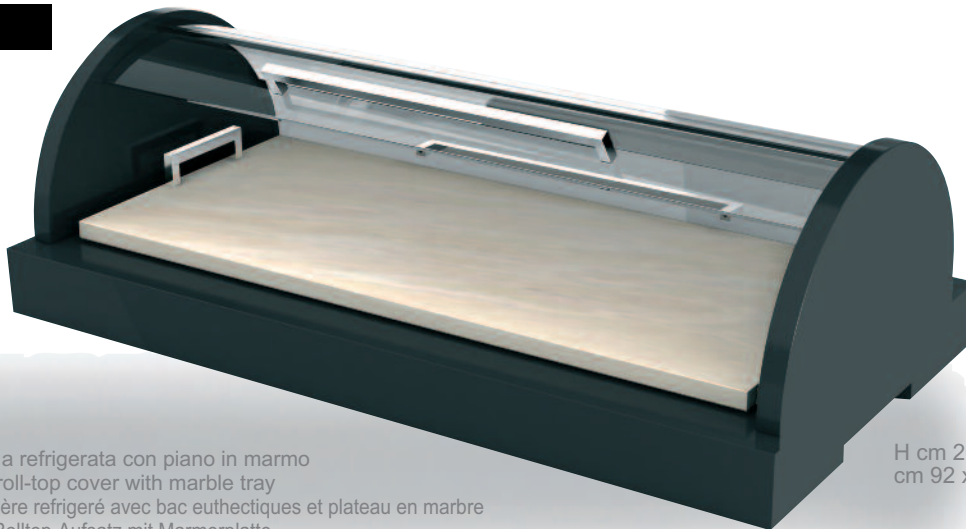

Cupola refrigerata con piano in marmo
Cool roll-top cover with marble tray
Lavallière réfrigéré avec bac eutectiques et plateau en marbre
Kühl-Rolltop-Aufsatz mit Marmorplatte
Cúpula refrigerada con plano en mármol

H cm 26,5
cm 92 x 47

H 10 1/2"
36 1/2" x 18 1/2"

DELUXE

161

162

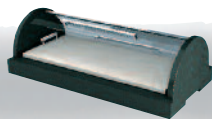
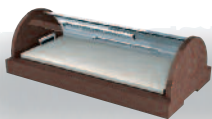

Massello
Solid wood
Massif
Massivholz
Tablero macizo

225

COLORI



- 2 Piastre eutettiche senza evaporatore sono già inserite nella cupola refrigerata
- 2 Eutectic cooling plates without evaporator are already inserted into the roll-top cover
- 2 Bacs eutectiques sans évaporateur sont déjà insérés dans la lavallière
- 2 Bereits eingelegte Kühlaccus gehören mit zum Lieferumfang
- 2 Planchas eutecticas sin vaporizador son ya insertadas en la cúpula refrigerada

		161	162	
		Noce Walnut Noyer Walnuss Nuez	Wengè	

TROLLEYS

WIEN

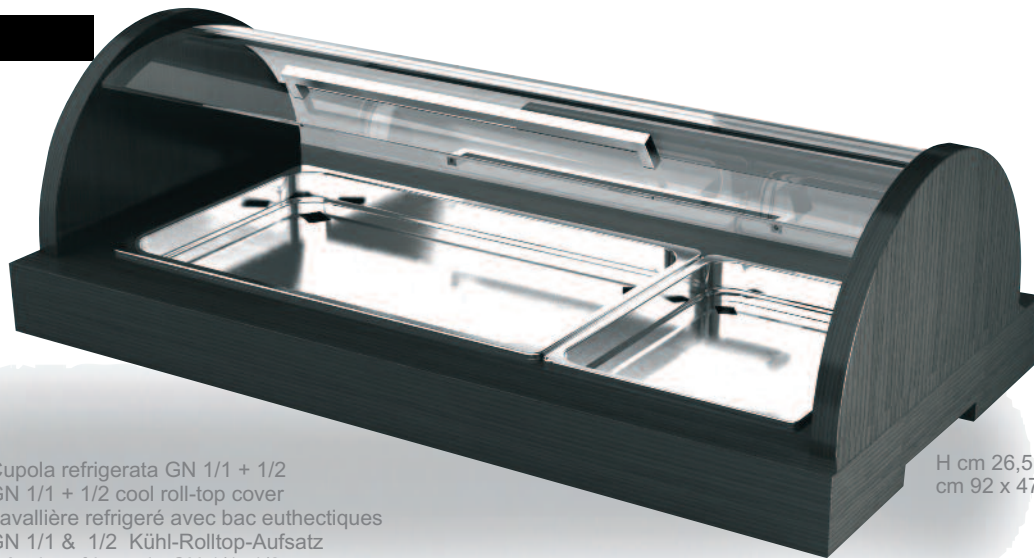

Cupola refrigerata GN 1/1 + 1/2
 GN 1/1 + 1/2 cool roll-top cover
 Lavallière réfrigéré avec bac eutectiques
 GN 1/1 & 1/2 Kühl-Rolltop-Aufsatz
 Cúpula refrigerada GN 1/1 -1/2

H cm 26,5
 cm 92 x 47

H 10 1/2"
 36 1/4" x 18 1/2"

DELUXE

141

142

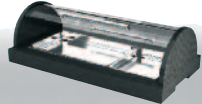
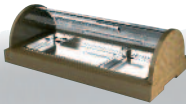

Massello
 Solid wood
 Massif
 Massivholz
 Tablero macizo

225

COLORI



- 2 Piastre eutettiche senza evaporatore sono già inserite nella cupola refrigerata
- 2 Eutectic cooling plates without evaporator are already inserted into the roll-top cover
- 2 Bacs eutectiques sans évaporateur sont déjà insérés dans la lavallière
- 2 Bereits eingelegte Kühlaccus gehören mit zum Lieferumfang
- 2 Planchas eutecticas sin vaporizador son ya insertadas en la cúpula refrigerada

		141	142	
		Noce Walnut Noyer Walnuss Nuez	Wengè	

TROLLEYS

TEVERE



H cm 80 H 31 1/2"
cm 80 x 40 31 1/2" x 15 3/4"

302



Pannello nobilitato in essenza
Laminated panel
Panneaux noble
Lackierte Paneele
Tablero lacado

309



Pannello nobilitato in essenza
Laminated panel
Panneaux noble
Lackierte Paneele
Tablero lacado

COLORI

302		309
Wengè		Castagno chiaro Light chestnut Châtain clair Heile Kastanie Castaño claro

TROLLEYS

MISSISSIPPI



H cm 85
cm 98 x 57

H 33 1/2"
38 3/8" x 22 3/8"

332



Pannello nobilitato in essenza
Laminated panel
Panneaux noble
Lackierte Paneele
Tablero lacado

339



Pannello nobilitato in essenza
Laminated panel
Panneaux noble
Lackierte Paneele
Tablero lacado

COLORI

332		339
Wengè		Castagno chiaro Light chestnut Châtain clair Heile Kastanie Castaño claro

TROLLEYS

RENO



H cm 85 H 33 1/2"
cm 50 x 50 19 3/4" x 19 3/4"

322



Pannello nobilitato in essenza
Laminated panel
Panneaux noble
Lackierte Paneele
Tablero lacado

329



Pannello nobilitato in essenza
Laminated panel
Panneaux noble
Lackierte Paneele
Tablero lacado

COLORI

322		329
Wengè		Castagno chiaro Light chestnut Châtain clair Heile Kastanie Castaño claro

Alta resistenza al graffio per il normale utilizzo

High resistance to scratch for normal use
 Hautes résistance aux griffures
 Kratzfest bei normalem Gebrauch.
 Alta resistencia a las rayas resultantes del uso normal

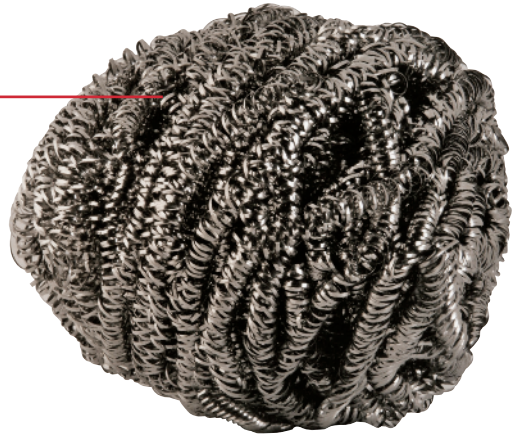
**Idrorepellente non cambia colore a contatto con liquidi e cibi**

Hydro repellant, it doesn't change colour when in contact with liquids or foods.
 Matière ne subissant aucunes agressions exterieurs, liquide et autres.....
 Wasserfest, keine Farbveränderung bei Kontakt mit Flüssigkeiten oder Esswaren.
 Repelente al agua, no cambia de color al entrar en contacto con líquidos y alimentos.

**Ruote speciali a grandezza maggiorata, fascia in gomma antistatica e antitraccia.
Ruote e struttura potenziate ad alta portata**

The oversized wheels are antistatic, won't leave marks.
 Wheels and enhanced high-range structure.
 Roulettes surdimensionnées spéciales, avec bande en caoutchouc synthétique conducteur antitrace.
 Roues et roulements adaptées en fonction du poids de la table roulante.
 Besonders grossdimensionierte Rollen mit antistatischen Gummireifen, die keinen Abrieb hinterlassen.
 Die Rollen und das Gefüge verstärkte sind, um grössere Fähigkeit zu tragen.
 Ruedas especiales de mayor tamaño, con cinta de goma antistatica y antihuellas.
 Ruedas y estructura mejoradas de alta capacidad.

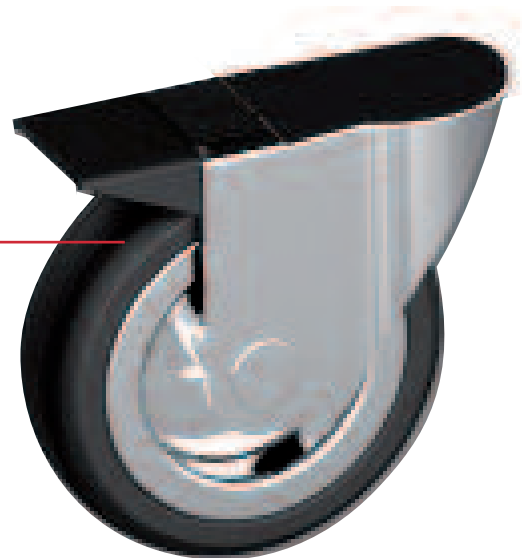



Ambiente Environment



Da molti anni MEPRA ha a cuore la salute dell'ambiente e dei lavoratori e l'uso sostenibile delle risorse ambientali, spesso anticipando di decenni le normative europee sul lavoro e sull'ambiente, investendo e puntando su impianti sempre più sicuri, alla ricerca di materiali e prodotti ausiliari sempre meno pericolosi, a garanzia della sicurezza e della salute del personale addetto e della comunità all'interno della quale l'azienda opera. Nei primi anni '80 del secolo scorso, gli impianti di lavaggio dei manufatti intermedi e finiti che utilizzavano solventi clorurati, vengono interamente rimpiazzati da impianti automatici che utilizzano sgrassanti a base acquosa (tunnel di lavaggio a tappeto). Nello stesso periodo gli impianti di pulitura e lucidatura della posateria manuali, vengono sostituiti da macchinari automatici a ciclo continuo, dotati di impianti di aspirazione e di abbattimento polveri. Negli anni '90, MEPRA, sempre più attenta alle tematiche ecologiche, trasforma i suoi impianti di lavaggio con soluzioni sgrassanti a base acquosa, che utilizzano e scaricano l'acqua per il lavaggio dei pezzi, in impianti che riciclano interamente le acque di lavaggio, filtrandole e re-immettendole nel ciclo senza alcuno scarico negli impianti fognari. Nel 1999 MEPRA con spirito innovativo si proietta verso il futuro, dotandosi di un sistema energetico altamente tecnologico; viene infatti installato un impianto di COGENERAZIONE. Viene utilizzato il metano come combustibile pulito, si genera elettricità per l'uso interno, si recupera il calore sprigionato dalla produzione elettrica, per il riscaldamento dei cicli produttivi che assorbono calore ed inoltre per il riscaldamento ambientale durante l'inverno, in modo da diminuire drasticamente l'inquinamento atmosferico prodotto dai gas serra. MEPRA rifiuta categoricamente ogni forma di sfruttamento del lavoro minorile ed investe ogni giorno per offrire alle nuove generazioni un futuro migliore, collaborando con le università e le scuole secondarie della comunità locale per formare i manager e i tecnici del futuro e per sostenere il mantenimento e l'accrescimento della cultura del lavoro, dei valori e delle competenze professionali che rappresentano una delle caratteristiche peculiari del distretto industriale all'interno del quale l'azienda opera.

Since many years MEPRA cares about the health of workers and the environment and sustainable use of environmental resources, often decades ahead of European regulations on labor and environment. Mepra invests and focus on safer and safer equipments, looking for materials and auxiliary products less and less dangerous, to guarantee safety and health of the workers as well as the community within which it operates. In the early 80s of last century, the washing equipment, previously based on chlorinated solvents, are entirely replaced by automatic systems that use water-based washing tunnels. In the same period the hand operated cutlery cleaning and polishing machineries, are replaced by continuous loop automatic machines, equipped with suction pumps and dust abatement equipment. In the '90s, MEPRA, more and more careful about the environment, converts washing systems previously using water-based degreasing solutions that were filtered and discharged into the sewers, into equipments that recycle the wastewaters by filtering and re-pumping them in the washing cycle without any waste in sewage plants. MEPRA in 1999 with an innovative spirit is projected into the future, adopting a high-tech energy system, a cogeneration system is in fact installed. It uses natural gas as clean fuel, electricity can be generated for internal use, it re-uses the heat generated from electricity production in production cycles and also for heating the plant during the winter, in order to drastically reduce carbon emissions. MEPRA categorically rejects all forms of child labor and invest every day to offer the new generations a better future, working with universities and secondary schools in the local community to train managers and technicians of the future and to carry-on work culture, values and skills that represent one of the characteristics of the industrial district in which the company operates.

CERTIFICATO SISTEMA DI GESTIONE

Certificato n.: 10092571372-MSG-ACCREDIA-ITA Data Prima Emissione: 28 agosto 2020 Validità: 28 agosto 2020 - 27 agosto 2023

Si certifica che il sistema di gestione di

Mepra S.p.A.
Via Virgilio Montini, 176 - 25067 Lumezzane (BS) - Italia

È conforme allo Standard:
ISO 9001:2015

Questa certificazione è valida per il seguente campo applicativo:
Progettazione, produzione e commercializzazione di: posateria, pentolame, vasellame ed oggettistica in acciaio inox per la tavola e la cucina per uso domestico, Hotel, Ristoranti e Catering (IAF 17)

Luogo e Data:
Vimercate (MB), 28 agosto 2020



ACCREDIA
CENTRO ITALIANO DI ACCREDITAMENTO

ALTA QUALITÀ ISO 9001:2015
SISTEMI DI GESTIONE ISO 14001:2015
SISTEMI DI GESTIONE ISO 45001:2018

ACCREDITAMENTO PER LE ATTIVITÀ DI PROGETTAZIONE, PRODUZIONE E COMMERCIALIZZAZIONE DI:
POSATERIA, PENTOLAME, VASELLAME ED OGGETTISTICA IN ACCIAIO INOX PER LA TAVOLA E LA CUCINA PER USO DOMESTICO, HOTEL, RISTORANTI E CATERING (IAF 17)

Per:
DNV GL - Business Assurance
Via Energy Park, 14, - 20871 Vimercate (MB) - Italy

Zeno Beltrami
Zeno Beltrami
Management Representative

Il mancato rispetto delle condizioni stabilite nel regolamento di certificazione potrebbe invalidare il certificato.
Per informazioni: 02 90 00 11 00 (ore ufficio) - 02 90 00 11 00 (ore ufficio) - 02 90 00 11 00 (ore ufficio)

MANAGEMENT SYSTEM CERTIFICATE

Certificate No.: 10092571372-MSG-ACCREDIA-ITA Initial certification date: 28 August 2020 Valid: 28 August 2020 - 27 August 2023

This is to certify that the management system of

Mepra S.p.A.
Via Virgilio Montini, 176 - 25065 Lumezzane (BS) - Italy

has been found to conform to the Quality Management System standard:
ISO 9001:2015

This certificate is valid for the following scope:
Design, production and commercialisation of: flatware, cookware, serverware and items in stainless steel for the table and kitchen for domestic use, Hotels, Restaurants and Catering (IAF 17)

Place and date:
Vimercate (MB), 28 August 2020



ACCREDIA
CENTRO ITALIANO DI ACCREDITAMENTO

ALTA QUALITÀ ISO 9001:2015
SISTEMI DI GESTIONE ISO 14001:2015
SISTEMI DI GESTIONE ISO 45001:2018

ACCREDITAMENTO PER LE ATTIVITÀ DI PROGETTAZIONE, PRODUZIONE E COMMERCIALIZZAZIONE DI:
POSATERIA, PENTOLAME, VASELLAME ED OGGETTISTICA IN ACCIAIO INOX PER LA TAVOLA E LA CUCINA PER USO DOMESTICO, HOTEL, RISTORANTI E CATERING (IAF 17)

For the issuing office:
DNV GL - Business Assurance
Via Energy Park, 14, - 20871 Vimercate (MB) - Italy

Zeno Beltrami
Zeno Beltrami
Management Representative

Il mancato rispetto delle condizioni stabilite nel regolamento di certificazione potrebbe invalidare il certificato.
Per informazioni: 02 90 00 11 00 (ore ufficio) - 02 90 00 11 00 (ore ufficio) - 02 90 00 11 00 (ore ufficio)

Abbiamo a cuore l'ambiente e il futuro del genere umano
Sin dal 1947 Mepra si trova ai piedi delle Prealpi Italiane. Siamo cresciuti e viviamo ogni giorno in simbiosi con le nostre montagne, abbiamo a cuore i nostri alberi, le nostre acque e l'aria che noi e i nostri figli respiriamo.

Nella lotta al cambiamento climatico ogni voce conta, anche la più piccola, in ogni angolo del mondo, e sentiamo la responsabilità di fare la nostra parte per assicurare un futuro migliore al pianeta.

Riduzione delle Emissioni di CO2

Con l'obiettivo di ridurre drasticamente le emissioni di CO2 Mepra si è impegnata ad installare un impianto fotovoltaico per produrre oltre 160.000 KWh all'anno e ridurre di conseguenza le emissioni di CO2 di 84.000 Kg. Il fabbisogno energetico residuo, nei mesi invernali, viene prodotto, per la maggior parte, con un sistema di cogenerazione. Questo impianto produce elettricità e, allo stesso tempo, il calore necessario per il riscaldamento dei locali aziendali, con un significativo risparmio energetico.

Riciclo

La maggior parte dell'acciaio utilizzato da Mepra nel processo produttivo proviene da fonti riciclate

Tutto lo scarto di produzione viene riciclato per produrre nuova materia prima

Gestione e recupero dei rifiuti

Mepra è da anni impegnata nella raccolta differenziata, non solo degli imballaggi, ma di tutti i rifiuti prodotti in azienda.

Conservazione delle risorse idriche

Dai primi anni '90 Mepra utilizza, all'interno del suo ciclo produttivo, un sistema di recupero dell'acqua di lavaggio e dei detergenti che vengono filtrati e re-immessi nel ciclo idrico senza alcuno scarico negli impianti fognari.

Utilizzo di sostanze non inquinanti:

Già dai primi anni '80, gli impianti di lavaggio dei manufatti intermedi e finiti che utilizzavano solventi clorurati, sono stati interamente rimpiazzati da impianti automatici che utilizzano sgrassanti a base acquosa (tunnel di lavaggio a tappeto).

Depurazione dell'aria

Nello stesso periodo gli impianti manuali di pulitura e lucidatura della posateria, sono stati sostituiti da macchinari automatici a ciclo continuo, dotati di impianti di aspirazione e di abbattimento polveri.

We have the future of the environment and the human species at heart

Since 1947 Mepra has been located at the foothill of the Italian pre Alps. We grew with and live in symbiosis with our mountains, day in day out, we care for our trees, our waters and the air we and our children breathe. In the fight against climate change every voice counts, even the faintest one, in every corner of the earth, and we feel the responsibility to play our part to ensure a better future for our planet.

Reduction of CO2 emissions

In the quest of drastically reducing CO2 emissions, Mepra has been working hard on the installation of a photovoltaic plant to produce more than 160.000 KWh per year, thus reducing CO2 emissions by 84.000 Kg.

The residual energy requirement in the winter months is produced for the most part by a cogeneration system that at the same time produces electricity and the necessary heat to heat up the offices, resulting in a significant energy saving.

Recycling

The majority of the steel used by Mepra in the production process comes from recycled sources. All the production waste is recycled to produce new raw material.

Waste management and recovery

For years Mepra has been practicing differentiated waste collection, not only with packaging, but all waste produced by the company.

Conservation of water resources

Since the early '90s Mepra uses a system that recovers the washing water and detergents used in production, by filtering them and re-introducing them in the water cycle without any discharge into the sewage system.

Use of non-polluting substances

Since the beginning of the 80's the washing machinery of the intermediate or finished products that used chlorinated solvents have entirely been replaced by automated machinery that use water-based degreasers.

Air purification

Always in the 80's the cleaning and polishing machinery used for cutlery have been replaced by automated loop machines equipped with dust suction and elimination systems.

B O B

BOB

AIUTA IL NOSTRO PIANETA
RIDUCI LA PLASTICA

Abbiamo creato una nuova linea di bottiglie riutilizzabili per garantire un futuro ai nostri oceani.

Per questo motivo il nome 'BOB = Blue Ocean Bottle', un progetto che ci aiuterà a ridurre l'utilizzo della plastica eliminando il consumo di bottiglie quotidiane.

BOB non è una semplice bottiglia termica, è l'esempio perfetto di utilità e eleganza fusi insieme.

We have created a new line of reusable bottles to grant a future to our oceans.

Hence the name "BOB = Blue Ocean Bottle", a project that will help us reduce the use of plastic by eliminating the consumption of daily plastic bottles. BOB is not a simple thermal bottle, it is the perfect example of utility and elegance fused together.

Perchè scegliere BOB? Why BOB?



Aiuta la salvaguardia dei nostri oceani.
Helps safeguard of our oceans.



Ferma il single use delle bottiglie di plastica.
Stops the single use of plastic bottles.



Diminuisce i batteri ingeriti che si annidano nelle bottiglie di plastica.
Reduces the ingested bacteria lurking in plastic bottles.



Durabilità nel tempo.
Longevity over time



Grazie al suo molteplici utilizzo, è un ottima scelta per risparmiare denaro.
Can be used multiple times and is an excellent way to save money.



BLUE OCEAN BOTTLE

BOB è una bottiglia termica di capacità 0,5 litri. Grazie alla doppia camera in acciaio inossidabile, mantiene la temperatura della bevanda calda 12h e fredda fino a 24h.

BOB è in grado di contenere qualsiasi bevanda, dall'acqua ai succhi di frutta, senza rischio di corrosioni o alterazioni.

BOB is a thermal bottle with 0.5 liter capacity . Thanks to its double stainless steel chamber, it keeps the hot temperature for 12 hours and the cold one for up to 24 hours.

BOB is able to hold any drink, from water to fruit juices, without the risk of corrosion or alterations.



Chiusura Termica

Thermal Closure

Bilaminato acciaio e rame

Bi-laminated steel and copper

Camera sotto vuoto

Vacuum room

Corpo esterno di protezione

External protection body

Triplo fondo

Triple bottom



COLORI DISPONIBILI
 AVAILABLE COLORS
 COULEURS DISPONIBLE
 VERFÜGBARE FARBEN
 COLORES DISPONIBLE:

W
 Bianco
 White
 Blanc
 Weiss
 Blanco



O7
 Arancio
 Orange
 Orange
 Orange
 Naranja



S7
 Rosso
 Red
 Rouge
 Rot
 Rojo



H7
 Lilla
 Lilac
 Lilas
 Lila
 Lila



Q7
 Oliva
 Olive
 green
 Olive
 Olivegrün
 Oliva



D7
 Lavanda
 Lavendal
 Lavande
 Lavendal
 Lavanda



693

BOB
 Bottiglia termica
 Insulated bottle
 Bouteille thermique
 Isolier Flasche
 Botella térmica

lt. 0,5
 oz. 16 7/8

O
 Oro
 Gold
 Or
 Gold
 Oro



B
 Rame
 Copper
 Cuivre
 Kupfer
 Cobre



N
 Nero
 Black
 Noir
 Schwarz
 Negro



You can save the oceans too, one bottle at a time!





INDICE

INDEX

INDEX

ALPHABETISCHES REGISTER

INDICE

NUMERI

RESTAURANT
HOTEL

Indice

A B	Pag
Agitatore	299
Agitatore Boston	299
Allacciatovaglioli	128 257
Alzata dolci	171 175 214 215 218 219 225 264
	286
Alzata pane	232 233 287
Alzata pesce crudo	156 157 158 221 229
Alzata portafrutta	156 157 214 215 218 229 264
Alzata portapiatti	219 285
Alzata torta	171 175 214 228 264
Ampolla	217 237 240 266
Antipastiera	246 256
Appoggia borse	282
Appoggia chop sticks	80
Appoggia posate	82 100 171 175 193 207
Apribottiglie	280
Apriostriche	158
Base per buffet	194 195
Bicchiere	152 176 200 204 338 339 344
Big champagnera	308
Bistecchiera	331
Bollilatte	335
Bottiglia termica	366 <> 369
Braciere con griglia	240 242
Bricco	145 291
Brocca per acqua	292
Bugia	225

C	
Caffettiera	218 289 290 292 293 294
Caffettiera termica	289 290 294
Candelabro	219 225
Caraffa per bibite	197 289 290 292
Caraffa termica	289 290
Carrello portavivande	346 <> 360
Casseruola	320 322 324 329 332
Cavatappi	280
Centrotavola	153 156 157 159 187 200
Cestino	123 124 126 127 128 133 144 147
	148 149 150 151 153 170 172 174
	175 180 184 191 193 200 216 232
	233 235 257 260 261 263 278 340
	344
Cestino portabonbon	178 180 263
Cestino portacondimenti	133 260 275 278
Cestino portafrutta	133 144 147 148 149 150 151 153
	232 235 260 263 306 307 340 344
Cestino portapane	133 144 147 148 149 184 191 193
	216 232 233 235 257 260 263 278
	340
Cestino portatovaglioli	191 232 287 296
Cesto porta agrumi	133 144 147 148 149 150 151 153
	232 235 260 263 306 307 340 344
Chafing dish	206 208
Champagnera	150 221 231 308 312 313
Chillcup	217 236
Chop sticks	80
Ciambella termica	247 249
Ciotola in acciaio	144 214 235 275
Ciotola in legno	275
Ciotola in policarbonato	133 307 308 338 340 341
Ciotola in polipropilene	344
Cloche	219 221 222 234 249 271 274 279
Coffee Urn	207
Colapasta	335
Colino da cocktail	280
Colonna porta big champagnera	309
Colonna portasecchiello	124 126 133 151 220 230 231 300
	301 302 303 304 305 307 313
Colonna portasigari	152
Coltelli	14 <> 70 84 86 102 116 158
	241
Contenitore per bibite	197 207
Coperchio	222 270 272
Coperchio per legumiera e zuppiera	222 272
Coperchio per piatto ovale	270
Coppa burro	217 236
Coppa caviale	217 236
Coppa cocktail e scampi	217 236
Coppa con piede	144 145 214 216 221 235 299
Coppa con vassoio	176 178 180 217 223 236
Coppa crema/potage	272
Coppa intermezzo	98 124 276
Coppa in vetro	216 247
Coppa lavadita	144 274
Coppa Martini	276 339
Coppa multiservizio	216
Coppa per champagne	221 225 299
Coppa per gelato e/o macedonia	145 178 180 223 235 236 278 286
	339
Coppa per pinzimonio	216 247
Coppa per punch	221 225 299
Coppa vichyssoise	217 236 272
Coppetta amouse bouche	100 176
Copripiatto	268 271
Cremiera	152 246 286 297

C	Pag
Cubetto luminoso LED	315
Cucchiaino da cocktail	14 <> 70 100 204
Cucchiaino per cappuccino	102 297
Cucchiaino per caviale	280
Cucchiaino sale	100 204
Cucchiaino agitatore	14 <> 70 102 104 297 314
Cucchiaino monoporzione	100 204
Cucchiaino multifunzione	94 161
Cucchiaino per bibita	14 <> 70 102 104 297 314
Cucchiaino per insalata	14 <> 70 104 117 207 208
Cucchiaino per miele	96
Cucchiaino per parmigiano	14 <> 70
Cucchiaino per risotto	102 104 117 207 208
Cucchiaino per salsa	14 <> 70 117 208 272
Cucchiaino servire	14 <> 70 102 104 117 207 208
Culla porta champagne	209
Cuocipasta	335
Cuociverdura	335

DEF	
Distributore di latte	207
Distributore di succo di frutta	207
Dosatore sale e pepe	152
Dosatore	299
Espositore per buffet	200
Finger food	100 104 131 160 <> 165 170 174
	183 193 200 204 210
	92 102
Forchetta aragosta	100 170 174 204
Forchetta monoporzione	100 170 174 204
Forchetta per insalata	14 <> 70 104 117 207 208
Forchetta per lumache	102
Forchetta servire	14 <> 70 102 104 117 207 208
Forchetta servire pesce	14 <> 70 104 117
Forchettina ostriche	14 <> 70
Forchettina cocktail	100 170 174 204
Forchettone	14 <> 70 102 104 117 207 208
Formaggiera	131 217 237 257 258 260 261 263
	267 274
Fruttiera	153 156 157 159 187

GHIL	
Glacette termica	302
Golf club mixer spoon	102 314
Grattugia	280
Gueridon d'appoggio	306
Happy spoon	104
Infusiera	197
Inserto per cuocipasta	335
Insalatiera	144 214 235 247 340 344
Inserto per finger food	131 163
Lasagnera	247 256
Lattiera	218 289 290 292 293 294
Legumiera	222 272
Legumiera escoffier	272

MNO	
Macine	281
Mestolo	14 <> 70 104 208 299
Micro forchetta	100 170 174
Micro presentoire	161 286
Mini burriera	142 223 237 262 265 275 286
Mini casseruola	320 322 324
Mini cestello	175
Mini forchetta	100 204
Mini presentoire	161 286
Mini spoon	100 204
Mini vaporiera	164
Mini vassoio	162 179 180 181 200 218
Misurino cocktail	299
Molla fonda per servire	210
Molla per aperitivi	210 291
Molla per asparagi	145 210 273
Molla per arrosto e verdure	145 210 273
Molla per dolci	210 273
Molla per Finger Food	210
Molla per frutta	210 273
Molla per ghiaccio	210 273 314
Molla per ghiaccio e limone	210
Molla per lumache	102 273 274
Molla per pane	210
Molla per pasticceria	210
Molla per servire	210 273
Molla per spaghetti	145 210 273
Molla per zucchero	210 273 291
Molla per zucchero ed aperitivi	210 291
Molla piana per servire	210
Mug	341
Numero da tavola	183 221 235 276 279
Oliera	131 223 237 257 258 260 261 263
	266 267

PQR	
Padella	321 323 325 329 330 334
Pala per torta	14 <> 70 104 116 207 208
Pentola	320 322 324 329 332
Petit marmite	206

Indice

P Q R	Pag
Piano	128 147 148 149 187 200 204 338
Piastra ad induzione ed elettrica	206
Piastra eutettica	356 357
Piattino	169 174 236 341
Piattino per burro	262 265
Piattino per lumache	274
Piattino per mug	341
Piattino per pane	147 265
Piattino per pasticceria	177 179 180
Piattino porta monete	174 299
Piattino sottocoppa	236
Piatto concavo	191 233
Piatto da presentazione	132 144 147 149 163 184 192 255 261 262 264 281 344
Piatto da torta	216 228
Piatto ovale	142 144 268 270
Piatto per buffet	338
Piatto per legumi	144 270
Piatto per ostriche	156 157 159
Piatto pesce	142 268
Piatto quadrato	148 200 246
Piatto rotondo	142 144 204 249 268 270 338
Piatto termico	249
Pietra ollare	240
Pinza aragosta	102
Pinza per antipasti e dolci	210 273 291
Pinza per dolci	210 273
Pinza per servire	145 210 273
Pinza per torta	210 273
Pinza per verdure	145 210 273
Pirofile e porcellane	247 256
Poggia pane	176
Porta badge	279
Porta bastoncini di zucchero	296
Porta bicchieri	257
Porta bottiglie	275 277
Porta burro e marmellata	275 297
Porta bustine da zucchero	191 218 232 287 294 296 297
Porta cannuce	314
Porta condimenti	133 260 275 278
Porta cono gelato	163 240
Porta crackers	176
Porta cucchiaini	299
Porta gioie	168 174
Porta grissini	149 176 184 191 193 277
Porta macarons	217 265 286
Porta marmellata	223 267 297
Porta menù	221 235
Porta noccioli	131 234
Porta numero	183 221 235 276 279
Porta pane porta grissini	149 176 183 184 191 193 277
Porta pasticcini	214 215 225 264 286
Porta patatine fritte	163 240 276
Porta piatti	219 257 285
Porta salatini	217 285 340 341
Porta salse	278
Porta salviettine	297
Porta sapone	297
Porta sigari	152
Porta sorpresa	168 174
Porta spazzolini	299
Porta spezie	256
Porta stuzzicadenti	183 193 217 223 232 237 266 267 272 278
Porta tacos	277
Porta toast	276 286
Porta tovaglioli	190 191 232 256 287 296
Porta uovo	142 275
Porta vivande	206 208
Portaghiaccio termico	230 302 303 304
Posacenere	149 152 274
Posate	14 <> 70 84 86 94 96 100 102 104 116 117 158 161 174 204 207 208 241 272 280 297 299
Presentoire	161 219 225 285 286 287
Quarta posata	88 <> 91 161 173
Rechaud	206 208
Rinfresca macedonia	221
Rinfrescatore per yogurt	208 221
Rinfrescavino bianco	302 303 305
Risottiera	256 318 322 324 329 331

S	Pag
Salino	217 267
Salsiera	142 272
Salvagoccia	277
Saucière	142 176
Sauteuse	244
Schiaccianoci	280
Scodella lavadita	144 274
Secchiello per ghiaccio	144 150 151 220 230 299 300 301 302 303 304 306 312 314 315 344
Secchiello per ghiaccio termico	230 302 303 304
Secchiello per spumante	124 144 150 151 184 220 230 299 300 301 302 303 304 305 306 307 308 312 314 315 340 344

S	Pag
Segnaposto	276
Servizio per antipasto	217
Servizio per caffè	222 291
Servizio per caviale	236
Servizio per champagne	303
Servizio per latte macchiato	297
Servizio per olio e aceto	260 275 278
Servizio per pinzimonio	247
Servizio per zucchero	223 265 285 291
Set impilabile	340 341
Set per aperitivi	131
Set per ceviche	279
Set sale e pepe	152 223 237 266 267 272
Sottobicchiere	255 262 265
Sottobottiglia	183 184 193 255 262 265 281
Sottopiatto	132 144 147 149 163 184 192 255 261 262 264 281 344
Spaghiettiera	335
Spargipepe	152
Spargisale	152 217 223 237 266 267 272
Spumantiera	150 231 308 312 313
Street cover	136 138
Supporto	246 247
Supporto per informazioni	221 235

T V W Z	Pag
Taglia tartufi	281
Tazza	341
Tegame	318 322 324 329 331 332
Tegamino friggiuova	145 274
Teiera	218 289 290 292 293 294
Teiera termica	294
Tiffin' box	250
Tovaglietta americana	132 136 138 183 192
Trolley	346 <> 361
Tubo per ghiaccio	197
Tumbler	176
Vaporiera	164
Vasetto portafiori	281
Vaso	169 174 344
Vassoietto	179 180 181 218
Vassoio	121 131 132 142 148 156 157 159 162 163 173 175 177 178 179 180 183 184 187 190 192 193 200 204 207 213 216 226 227 228 232 233 234 252 255 258 260 261 262 270 271 277 278 286 287 296
Vassoio concavo	277
Vassoio conto	149
Vassoio gn	183 184 192 213 226
Vassoio in carbonio	120 121
Vassoio ovale	148 157 162 187 216 228 261 271
Vassoio per carrelli	184 233 252
Vassoio petit four	177 178 179 180 181
Vassoio portabicchieri impilabile	233
Vassoio prima colazione	131
Vassoio quadrato	132 148 156 162 163 183 193 200 227 255 260
Vassoio rettangolare	121 131 132 142 148 156 162 183 184 187 190 192 193 200 204 207 213 216 226 227 228 232 233 234 252 255 258 260 261 262 270 271 277 278 286 287 296
Vassoio rotondo	157 159 173 175 213 216 227 228 234 255 258 262
Versatore per profumo	223
Vetrina (cupola) refrigerata	356 357
Wok	331 335
Zuccheriera	145 152 218 289 290 292 293 294 296 297
Zuppiera	206 222 272
Zuppiera monoporzione	272

Index

A B

	Pag
Accessories	80 <> 105
Afternoon tea stand	219 285
Amenities tray	131 132 133 163 184 232 287 297
Appetizer bowl	131 176
Appetizer set	131
Asparagus tongs	145 210 273
Bags support	282 283
Bar spoon	102 104 297 314
Basket for aromatic condiments	258 275 278
Beverage server	197 289 290 291 292
Beverage server, insulated	289 290
Big wine party tub	150 221 231 308 312 313
Boston shaker	299
Bottle cooler	302
Bottle, insulated	366 <> 369
Bottle opener	280
Bottle stand/coaster	183 184 193 252 260 262 281
Bowl	144 147 148 149 175 176 180 200
	214 216 223 233 235 257 275 307
	338 340 341 344
	307 308 340
Bowl, small	100 144 176 178 214 216 235 275
	340 341 344
Bread basket	133 144 147 148 149 184 191 193
	216 232 233 235 257 260 263 278
	340
Bread plate	147 265
Bread stand	190 232 287
Bread/Pastry tongs	210
Breakfast tray	131
Buffet rack	200 338
Buffet showcase, cooled	356 357
Butter cup and dish	217 236 262 265 275 297

C

Caf� au lait set	222 291 297
Cake server	14 <> 70 104 116 207 208
Cake stand	171 175 214 215 218 219 225 264
	286
Candlestick	219 225
Carbon fiber tray	120 121
Carving fork	16 <> 70 102 117
Cash tray	174 299
Caviar cup	217 236
Caviar set	236
Caviar spoon	280
Casserole	320 322 324 329 332
Centerpiece	153 156 157 159 187 200
Ceviche set	279
Chafing dish	206 208
Champagne bowl	150 221 231 308 312 313
Champagne bowl stand	124 126 133 151 220 230 231 300
	301 302 303 304 305 307 313
Champagne bucket	124 144 150 151 184 220 230 299
	300 301 302 303 304 305 306 307
	308 312 314 315 340 344
Champagne holder	209
Charger	132 144 147 149 163 184 192 255
	261 262 264 281 344
Chillcup	217 236
Chilli mill	281
Chips cone holder	163 238 276
Chopsticks	80
Chopsticks rest	80
Cigar ash tray	149 152 274
Cloche	219 221 222 234 249 271 274 279
Cloche for wedding cake stand	222 234 279
Cocktail measuring cup double	299
Cocktail strainer	280
Coffee cup	341
Coffee dispenser solid alcohol heating	207
Coffee pot	218 289 290 292 293 294
Coffee pot, insulated	289 290 294
Coffee urn	207
Colander	335
Cookware	316 <> 335
Cooled juice pitcher	289 290 292
Cork screwer	280
Cover	268 271
Cover for oval meat dish	268
Cover for soup tureen and vegetable dish	268 270 271
Creamer	152 246 286 297
Cruet	217 237 240 266
Cruet set	133 223 237 257 258 259 260 261
	263 266 267
Cup and tray	176 178 180 217 223 236
Cup with feet	144 145 214 216 221 235 299

DEF

Deep serving tongs	273
Dish cover	268 271
Dome cover for dish	219 221 222 234 249 271 274 279
Egg cup	142 275
Electric heating unit	206
Escargot fork	102
Escargot plate	274

DEF

Escargot tongs	102 273 274
Eutectic pads	355 356
Finger bowl	144 274
Finger food	100 104 131 160 <> 165 170 174
	183 193 200 204 210
Finger food insert	131 162
Finger food tongs	210
Fish dish	142 268
Fish serving fork	14 <> 70 104 117
Fish serving knife	14 <> 70 104 117
Flat serving tongs	210
Flatware	14 <> 70 84 86 94 96 100
	102 104 116 117 161 204 207 208
	241 280
Flower vase	281
Food pan	202 204
French fry holder	163 239 276
Front cooking & Apartments	316 <> 335
Fruit basket	149 153 156 157 187 200
Fruit bowl	133 144 147 148 149 150 151 153
	232 235 260 263 306 307 340 344
	144 214 235 338 340
Fruit salad bowl	156 157 214 215 218 229 264
Fruit stand	210 273
Fruit tongs	321 323 325 329 330 334
Frying pan	145 274
Frying pan for eggs	145 274

GHIJKL

Giant champagne bucket	308
Glass	152 176 200 204 338 339 344
Glass coaster	255 262 265
Golf club mixer spoon	102 314
Grated cheese pot	131 217 237 257 258 260 261 263
	267 274
Grater	280
Gravy boat	138 266
Grill	331
Gueridon	306
Happy spoon	104
Herbs mill	281
Holder	221 235 246 247
Honey spoon	96
Hors d'oeuvre tray	246 256
Hors d'oeuvre and pastry pliers	273 274
Ice and lemon tongs	210
Ice bucket	144 150 151 220 230 299 300 301
	302 303 304 306 312 314 315 344
Ice bucket, insulated	230 302 303 304
Ice cream cup	145 178 180 223 235 236 278 286
	339
Ice tea spoon	14 <> 70 75 104 293 310
Ice tongs	210 273 314
Intermezzo cup	98 124 276
Infuser jug	197
Infuser jug insert	197
Induction cooker	206
Jam and honey holder	223 267
Jar	174
Jug	145 289 290 291
Juice dispenser	207
Kernel holder	131 234
Kitchen set	332
Knife rest	82 100 171 175 193 207
Knives	14 <> 70 84 86 102 116 158
	241
Ladle	14 <> 70 104 208 299
LED Ice cubes	315
Lobster cracker	102
Lobster pick	92

MNO

Meat dish	142 268
Micro fork	100 170 174
Micro and Mini presentoire	161 286
Milk boiler	335
Milk dispenser	207
Milk pot	218 289 290 292 293 294
Mini basket	175
Mini butter dish	142 223 237 275 286
Mini casserole	320 322 324
Mini fork	100 204
Mini spoon	100 204
Mini steamer	164
Mini table stand	279
Mini tray	162 179 180 181 200 218
Mixing glass	299
Monoportion fork	100 170 174 204
Monoportion spoon	100 170 174 175 204
Mug	341
Multifunctional spoon	94 161
Multipurpose bowl	216
Napkin holder	190 191 232 256 287 296
Napkin ring	128 257
Nut-cracker	280
Oil and vinegar set	260 275 278
Oil pourer	131 223 237 257 258 260 261 263

Index

M N O

Oil pourer	266 267
Oval meat dish	142 144 268 270
Oval dish/china	247 256
Oyster fork	14 <> 70
Oyster plate	156 157 159

P Q R

Parmesan cheese basin	131 217 237 257 258 260 261 263 267 274
Parmesan spoon	14 <> 70
Party forks	100 170 174 204
Party spoon	14 <> 70
Pasta pot	335
Pasta pot insert	335
Pastry pliers	210 273
Pastry stand	171 175 214 215 218 219 225 264 286
Patè holder	142 223 237 286
Pepper grinder	281
Pepper shaker	152 223 237 266 267 272
Perfume drops dispenser	223
Petit four stand	171 175 214 215 218 219 229 264 285
Petit marmite	206
Pie pliers	210 273
Pinzimonio set	247
Plate cover, round	269 269 270 271
Plate, crescent	191 233
Plates	142 144 147 169 174 177 179 180 191 216 228 233 236 246 262 265 268 270 274 299 341
Pliers	102 145 210 273 274 291 314
Polycarbonate drinkware	336 <> 339
Porcelain insert	247 256
Presentoire	161 219 225 285 286 287
Punch bowl	221 225 299
Quarta Posata	88 <> 91 161 173
Relish dish	217 285 340 341
Riser	194 195
Room service system	249

S

Salad bowl	144 214 235 307 340 344
Salt and pepper set	152 223 237 266 267 272
Salt cellar	217 267
Salt grinder	281
Salt shaker	152 223 237 266 267 272
Salt spoon	100 204
Salt/Pepper dispenser	152 223 237 266 267 272
Sauce boat	142 272
Sauce bowl	278
Sauce spoon	14 <> 70 104
Saucepan	320 322 324 329 332
Saucer	169 174 236 262 265 341
Sauteuse	244
Seafood stand	156 157 158 221 229
Serving fork	14 <> 70 102 104 117 207 208
Serving pliers	145 210 273
Serving spoon	14 <> 70 102 104 117 207 208
Serving tongs	145 210 273
Set for Risotti	256
Shaker	299
Show plate	132 144 147 149 163 184 192 255 261 262 264 281 344
Small spoon	100 204
Snack server	217 285 340 341 2
Soapstone	240
Soap tray	297
Soup cup	272
Soup tureen	206 222 272
Spaghetti tongs	145 210 273
Square tray	132 148 156 162 163 183 193 200 227 255 260
Stackable tray	226 227 233
Stackable tray for glasses	233
Stock pot	320 322 324 329 332
Street cover	137 139
Sugar bowl	145 152 218 289 290 292 293 294 296 297
Sugar, milk and coffee set	222 291
Sugar set	222 223 265 285 291
Sugar tongs	210 273 291
Sugar and cocktails tongs	210 291
Sugar/Tea bags holder	191 218 232 287 296 297
Supreme cup	217 236

T U V W Y

Table grill	240 242
Table mat	132 136 138 183 192
Table number	183 221 235 276 279
Table number stand	183 221 235 276 279
Tacos holder	277
Tall container	123 124 126 144 151 184
Tea cup	341
Tea pot	218 289 290 292 293 294
Tea pot, insulated	294

T U V W Y

Thermal serving unit	247 249
Tiffin' box	250
Toast rack	276 286
Toast/Pastry tongs	210 273
Tongs	102 145 210 273 274 291 314
Toothpick holder	183 193 217 223 232 237 266 267 272 278
Tray	121 131 132 142 148 156 157 159 162 163 173 175 177 178 179 180 183 184 187 190 192 193 200 204 207 213 216 226 227 228 232 233 234 235 255 258 260 261 262 270 271 277 278 286 287 296
Tray for rack trolley	184 233 252
Tray gn	183 184 192 213 226
Tray, oval	148 157 162 187 216 228 261 271
Tray, rectangular	121 131 132 142 148 156 162 183 184 187 190 192 193 200 204 207 213 216 226 227 228 232 233 234 252 255 258 260 261 262 270 271 277 278 286 287 296
Tray, round	157 159 173 175 213 216 227 228 234 255 258 262
Tray, square	132 148 156 162 163 183 193 200 227 255 260
Tray with holes	175
Trolley	346 <> 361
Truffle slicer	281
Tumbler	176
Underliner	236
Vacuum jug	289 290
Vase	169 174 344
Vegetable dish	222 272
Vegetable dish escoffier	272
Vegetable/Meat tongs	145 210 273
Vegetable pliers	145 210 273
Vegetable steamer	335
Vichyssoise cup	217 236 272
Vinegar dispenser	217 237 240 266
Water pitcher	197 289 290 292
Water pitcher, insulated	289 290
Wine cooler	302 303 305
Wine cooler stand	124 126 133 151 220 230 231 300 301 302 303 304 305 307 313
Wine holder	209 275
Wok	331 335
Yogurt cooler	208 221

Index

A B

Accessoires	80 <> 105
Ardoise	240
Assiette de bienvenue	132 144 147 149 163 184 192 255
	261 262 264 281 344
Batteries de cuisine	332
Beurrir	142 223 237 275 286
Bol	123 124 126 127 128 133 144 147
	148 149 150 151 153 170 172 174
	175 180 184 191 193 200 216 232
	233 235 257 260 261 263 278 340
	344
Bol à caviar	217 236
Bol à champagne	221 225 299
Bol à punch	221 225 299
Bol à rafraîchir	208 221
Bol à salade de fruits	144 214 235 247 340 344
Bol à sauce	278
Bol à snacks	217 285 340 341
Bol avec socle	144 145 214 216 221 235 299
Bol en bois	275
Bol en polycarbonate	133 307 308 338 340 341
Bol en polypropylène	344
Bol en verre	216 247
Bol universel	100 176
Boston shaker	299
Bouilleur	207
Bouilloire à lait	335
Borne étouffoir	152
Bouteille thermique	366 <> 369
Brasero avec pierres naturelles	240 242
But de canapé	306

C

Cache eau mineral	277
Cafetière	218 289 290 292 293 294
Cafetière thermique	289 290 294
Carafe	197 289 290 292
Carafe à eau	197 289 290 292
Carafe à eau thermique	289 290
Cartouches eutectiques	356 357
Casse-noix	280
Cendrier	149 152 274
Cendrier à cigares	149 152 274
Centre de table/Comptoir	153 156 157 159 187 200
Chafing-dish	206 208
Chandelier	219 225
Chandelier/bougeoir	225
Chariot	346 <> 361
Chariot de service	227
Chopsticks	80
Cloche pour plat	219 221 222 234 249 271 274 279
Cloche pour plat ovale	270
Cloche pour plat rond	219 234 249 271 274
Cloche support à tartes	222 234 279
Coffee Urn	207
Conteneur à thé	218 289 290 292 293 294
Coquetier	145 274
Corbeille	123 124 126 127 128 133 144 147
	148 149 150 151 153 170 172 174
	175 180 184 191 193 200 216 232
	233 235 257 260 261 263 278 340
	344
Corbeille à pain	133 144 147 148 149 184 191 193
	216 232 233 235 257 260 263 278
	340
Corbeille pour aromatiques condiments	133 260 275 278
Corps de chauffe électrique	206
Coupe à beurre	142 223 237 262 265 275 286
Coupe à caviar	217 236
Coupe à creme/potage	272
Coupe à crevettes	217 236
Coupe à fruits	145 178 180 223 235 236 278 286
	339
Coupe à glace	145 178 180 223 235 236 278 286
	339
Coupe à intermezzo	98 124 276
Coupe à Martini	276 339
Coupe à punch	221 225 299
Coupe à suprême	217 236
Coupe à vichyssoise	217 236 272
Coupe multifonctions	216
Coupe sur pied	144 145 214 216 221 235 299
Coupe thermique à glace	235 278 286
Coupelle	100 147 148 149 176 200 214 235
	274 275 340 341 344
Coupe-truffes	281
Couteau à huitres	158
Couteau à servir poisson	14 <> 70 104 117
Couteaux	14 <> 70 84 86 102 116 158
	241
Couvercle	222 270 272
Couvercle légumier	222 272
Couverts	14 <> 70 84 86 94 96 100
	102 104 116 117 158 161 174 204
	207 208 241 272 280 297 299
Couvre-plat	268 271

C

Crémier	152 246 286 297
Cuiller à bar	14 <> 70 102 104 297 314
Cuillère à miel	96
Cuiller à risotto	102 104 117 207 208
Cuiller à servir	14 <> 70 102 104 117 207 208
Cuiller à soda	14 <> 70 102 104 297 314
Cuillèr cocktail	14 <> 70 100 204
Cuillère à glace	14 <> 70 102 104 297 314
Cuillère à parmesan	14 <> 70
Cuillère à sauce	14 <> 70 117 208 272
Cuillère à sel	100 204
Cuillère monoportion	100 170
Cuillère multifonctionnelle	94 161
Cuit pâtes	335
Curette à homard	92 102

DEF

Décapsuleur	280
Dessous de bouteille	183 184 193 255 262 265 281
Dessous de verre	255 262 265
Distributeur à jus	207
Distributeur à lait	207
Distributeur de serviettes	190 191 232 256 287 296
Doseur	299
Douser sel/poivre	152
Ecuelle	144 274
Élément pour cuit pâtes	335
Étagère	156 157 158 175 180 214 215 221
	225 229 264
Étiquettes	183 221 235 276 279
Faitout	320 322 324 329 332
Finger food	100 104 131 160 <> 165 170 174
	183 193 200 204 210
Fourchette amouse-bouche	100 170 174 204
Fourchette à escargots	102
Fourchette à fromage	102
Fourchette à huitres	14 <> 70
Fourchette à servir	14 <> 70 102 104 117 207 208
Fourchette à servir poisson	14 <> 70 104 117
Fourchette cocktail	100 170 174 204
Fourchette monoportion	100 170 174 204
Fromagère	131 217 237 257 258 260 261 263
	267 274

GHIL

Glacette thermique	302
Glaçon lumineux	315
Golfrosse pour cocktail	102 314
Gril	331
Huiliér	217 237 240 266
Huillier/vinaigrier	131 223 237 257 258 260 261 263
	266 267
Légumier	222 272
Légumier escoffier	272
Louche	14 <> 70 104 208 299

MNO

Marmite traiteur	320 322 324 329 332
Ménagère	131 223 237 257 258 260 261 263
	266 267
Mesure à alcool, double	299
Micro fourchette	100 170 174
Mini corbeille	175
Mini faitoute	320 322 324
Mini marquer de table	279
Mini spoon	100 204
Mini plateau	162 179 180 181 200 218
Mini vaporisateur	164
Moulin à herbes	281
Moulin à piment	281
Moulin à poivre	281
Moulin à sel	281
Mug	341
Numéro de table	184 221 235 276 279
Ouvre-bouteilles	280

PQ

Panier à fruits	133 144 147 148 149 150 151 153
	232 235 260 263 306 307 340 344
Passoire	335
Passoire à cocktail	280
Pelle à gâteau / à tarte	14 <> 70 104 116 207 208
Petit sous-plat	147 169 174 236 265 299 341
Petite marmite	206
Petite plateau	162 179 180 181 200 218
Pied pour bol a champagne	309
Pied pour seau à champagne	124 126 133 151 220 230 231 300
	301 302 303 304 305 307 313
Pince	102 145 210 273 274 291 314
Pince à amuse-bouche	210 291
Pince à asperges	145 210 273
Pince à escargots	102 273 274
Pince à fruits	210 273
Pince à glace	210 273 314
Pince à glaçon et citron	210
Pince à homard	102

Index

P Q

	Pag
Pince à hors-d'oeuvres et pâtisserie	210 273 291
Pince à légumes	145 210 273
Pince à pain et pâtisserie	210
Pince à pâtisserie	210
Pince à rôti	145 210 273
Pince à servir	210
Pince à spaghetti	145 210 273
Pince à sucre	210 273 291
Pince à sucre et apéritifs	210 291
Pince à tarte	210 273
Pince à toast et tarte	210 273
Pince fonde pour servir	210
Pince plaine pour servir	210
Plaque à induction	206
Plat à escargots	274
Plat à huîtres	156 157 159
Plat à oeuf	142 275
Plat à pain	147 265
Plat à poisson	142 268
Plat à présentation	132 144 147 149 163 184 192 255 261 262 264 281 344
Plat oval	142 144 268 270
Plat rond	142 149 204 249 268 270 338
Plateau	121 131 132 142 148 156 157 159 162 163 173 175 177 178 179 180 183 184 187 190 192 193 200 204 207 213 216 226 227 228 232 233 234 252 255 258 260 261 262 270 271 277 278 286 287 296
Plateau à hors d'oeuvre	246 256
Plateau à monnaie	174 299
Plateau avec trousse	175
Plateau carré	132 148 156 162 163 183 193 200 227 255 260
Plateau concave	277
Plateau en fibre de carbone	120 121
Plateau gn	183 184 192 213 226
Plateau ovale	148 157 162 187 216 228 261 271
Plateau porte verres empilable	233
Plateau pour chariot porte-plateau	184 233 252
Plateau rond	157 159 173 175 213 216 227 228 234 255 258 262
Plateau, rectangulaire	121 131 132 142 148 156 162 183 184 187 190 192 193 200 204 207 213 216 226 227 228 232 233 234 252 255 258 260 261 262 270 271 277 278 286 287 296
Poêle	321 323 325 329 330 334
Poivrier	152
Porcelaine	247 256
Porte brosse à dents	299
Porte confitures	223 267 297
Porte craquelins	176
Porte cure-dents	183 193 217 223 232 237 266 267 272 278
Porte gobelets	257
Porte gressin	149 176 184 191 193 277
Porte macarons	217 265 286
Porte noyaux	131 234
Porte petits fours	214 215 225 264 286
Porte pommes frites	163 240 276
Porte savon	297
Porte serviette	297
Porte-appetizers	217 285 340 341
Porte-badge	279
Porte-bouteille	275 277
Porte-pate/beurre/caviar	142 223 237 286
Porte-surprises	168 174
Porte toast	276 286
Pot à cuillères	299
Pot à lait	218 289 290 292 293 294 335
Pot à sucre	145 152 218 289 290 292 293 294 296 297
Presentoire	161 219 225 285 286 287
Quarta Posata	88 <> 91 161 173

R S

Râpe	280
Rafraichisseur à bouteille	302
Rafraichissoir à yogourt	208 221
Ravier à parmesan	131 217 237 257 258 260 261 263 267 274
Rechaud à cafe	207
Rince doigts	144 274
Saladier	144 214 235 247 340 344
Salière	217 267
Saucière	142 272
Sauteuse	244
Seau à champagne	124 144 150 151 184 220 230 299 300 301 302 303 304 305 306 307 308 312 314 315 340 344
Seau à glace	144 150 151 220 230 299 300 301 302 303 304 306 312 314 315 344
Seau à glace, thermique	230 302 303 304
Seau à vin	124 144 150 151 184 220 230 299 300 301 302 303 304 305 306 307

R S

	Pag
Seau à vin	308 312 314 315 340 344
Service à caviar	236
Set de table	132 136 138 183 192
Set pinzimonio	247
Set pour Amouse bouche	131
Set pour ceviche	279
Set salière, poivrier	152 217 223 237 266 267 272
Shaker	299
Soliflore	281
Soupière avec couvercle	206 222 272
Sous plat	132 144 147 149 163 184 192 255 261 262 264 281 344
Sous bouteille	183 184 193 255 262 265 281
Sous verre	255 262 265
Soutier de sacs	282
Soutier porte-couverts	82 100 171 175 193 207
Stands de buffet	194 195
Street Cover	136 138
Sucrier	145 152 218 289 290 292 293 294 296 297
Support	246 247
Support à tarte	171 175 214 228 264
Support avec numéro de table	183 221 235 276 279
Support pour seau à champagne / à vin	124 126 133 151 220 230 231 300 301 302 303 304 305 307 313
Support pour tacos	277
Support pour toast	276 286

T V W

Tasse	341
Théière	218 289 290 292 293 294
Théière thermique	294
Tiffin box	250
Tire-bouchon	280
Tumbler	176
Vase	169 174 344
Vase à fleurs	281
Verre	152 176 200 204 338 339 344
Verseur de parfum en gouttes	223
Vinaigre	217 237 240 266
Vitrine réfrigérée	356 357
Wok	331 335

Alphabetisches Register

A B C

	Pag
Aderhalter	131 234
Ascher	149 152 274
Ascherständer	152
Auflaufform auf Porzellan	247 256
Austernöffner	158
Badge-Halter	279
Bargestell	217 285 340 341
Beilagenschale	144 274
Beutelstand	282
Bierbecher	339
Blumenvase	281
Bonbonsschale	168 174 263
Boston Shaker	299
Bowlenöffel	299
Bratenplatte	142 268
Bratentopf	320 322 324 329 332
Bratpfanne	321 323 325 329 330 334
Brot Platte	147 265
Brotkorb	133 144 147 148 149 184 191 193 216 232 233 235 257 260 263 278 340
Brottschale	133 144 147 148 149 184 191 193 216 232 233 235 257 260 263 278 340
Buffet Display	200
Buffetständer	194 195
Buffet-Tablett	120 121 132 148 156 157 159 180 183 184 187 190 192 193 200 204 207 213 216 218 221 226 227 228 233 234 252 260 261 262 268 277 278 338
Butterdose	142 223 237 275 286
Butterkühler	262 265
Café au Lait-Set	222 291
Cappuccinolöffel	102 297
Cevichese	279
Chafing dish	206 208
Chafing dish besteck	207 208
Champagner Bowl	150 221 231 308 312 313
Champagner Bowlständer	309
Champagnerflaschenhalter	209
Champagnerglas	204 339
Chilimühle	281
Chillcup	217 236
Cocktailsieb	280
Coffee Urn	207
Cracker Schale	176

DEF

Deckel	222 270 272
Dessertgestell	219 285
Dressingbehälter	142 272
Dressinglöffel	14 <> 70 117 208 272
Eierbecher-Set	142 275
Eierlöffel	14 <> 70
Eierpfanne	145 274
Einsatz Tablett	131 163
Eis- und Zitronenzange	210
Eisbecher	145 178 180 223 235 236 278 286 339
Eisfruchtbecher, Isoliert	235 278 286
Eisgefäß	144 150 151 220 230 299 300 301 302 303 304 306 312 314 315 344
Eisgefäß, Isoliert	230 302 303 304
Eislöffel	14 <> 70 102 104 297 314
Eisschale	236
Eisschaufel	14 <> 70
Eiswasserkrug	197 289 290 292
Eiswürfel LED	315
Eiszange	210 273 314
Essig-/Ölflasche	217 237 240 266
Essig-/Ölflaschenhalter	133 260 275 278
Essig-/Ölgestell	223 237 266 267
Essig-/Öl-Menage	131 223 237 257 258 260 261 263 266 267
Ess-Stäbchen Paar	80
Ess-Stäbchen Ablage	80
Etagère	156 157 158 175 214 215 221 225 229 264
Feuerschale	240 242
Fingerfoodzange	210
Fingerfood-/Vorspeisen-/Butter-Gefäß	100 131 149 162 163 176 200 204 216 217 234 236 240 262 265 275 276 340 341
Fingerschale	144 274
Fischplatte	142 268
Flachzange zum Servieren	210
Flasche, Isoliert	366 <> 369
Flaschenhalter	275 277
Flaschenteller	183 184 193 255 262 265 281
Fleischgabel	14 <> 70 102 104 117 207 208
Früchtekorb	133 144 147 148 149 150 151 153 232 235 260 263 306 307 340 344
Frühstück Tablett	131

G H K

	Pag
Gebäckplatte	142 271
Gebäck- und Servierzange	210 274
Gemüseseiher	335
Gemüsetopf	335
Getränkekühler	152 207 208 231 289 290 302 313
Gewürzmenage	267
Gewürzständer	256
Glas	152 176 200 204 338 339 344
Glassflasche	217 237 240 266
Glaskrug	197
Glasschale	216 247
Glasuntersatz	255 262 265
Golf Schleger	102 314
Gratinplatte	142 270 271
Griffschale	127 128 147
Grifftablett	128 147
Grill Pfanne	331
Grissini-Halter	149 176 184 191 193 277
Gueridon	306
Happy Spoon	104
Heizelement	206
Honiglöffel	96
Hummergabel	92 102
Hummerzange	102
Innenteil für Spaghettitopf	335
Kaffeekanne	218 289 290 292 293 294
Kaffeekanne, isoliert	289 290 294
Kaffeespender	207
Kaffeetablett	296
Kartenhalter	221 235
Kartoffenbehälter	163 240 276
Kartoffellöffel	14 <> 70
Kasserolle	320 322 324 329 332
Kaviarkühler	217 236
Kaviarlöffel	280
Kaviarschale	217 236
Korkenheber	280
Korkenzieher	280
Kuchen-/Tortenplatte	216 228
Käsedose	131 217 237 257 258 260 261 263 267 274
Käsemesser	14 <> 70
Kohlefaser-Tablett	120 121
Kühlschale	156 157 158 159 208 221
Kühlvitrine	356 357

LMN

Latte Macchiato-Set	297
Légumier	144 222 270 272
Leuchter	219 225
Löffelbecher	299
Macaronsträger	217 265 286
Marmeladegestell	223 267 297
Martini Glass	276 339
Milchdispenser	207
Milchkaffee-Set	222 291
Milchkanne	218 289 290 292 293 294
Milchkännchen	152 246 286 297
Milch-Kaffee-Zucker-Set	222 291
Milchkocher	335
Mikrogabel	100 170 174
Mini Bratentopf	320 322 324
Mini Butterdose	142 223 237 275 286
Mini Gabel	100 204
Mini Schale	175
Mini Spoon	100 204
Mini Tablett	162 179 180 181 200 218
Mini Verdampfer	164
Mokkaétagère	180 215 225 264
Mug	341
Multifunktionaler Löffel	94 161
Nussknacker	280

OPQ

Obstschale	144 148 149 153 156 157 159 187 200 214 216 218 228 235 260 261 263 278 338 341 344
Papierbecherständer	257
Patisserie Tablett	190 232 233 287 296
Petits Fours-Ständer	171 175 214 215 218 219 225 264 286
Petits Fours-Tablett	177 178 179 180 181
Pfeffermühle	281
Pfefferstreuer	152
Platten	142 147 147 191 216 228 233 236 246 256 265 268 270 271 274 297 261 262 264 281 344
Platzteller	132 144 147 149 163 184 192 255
Portionsschöpfer	14 <> 70 104 208 299
Porzellanschale	247 256
Presentoire	161 219 225 285 286 287
Punchbowl	221 225 299
Quarta Posata	88 <> 91 161 173

RS

Reibe	280
-------	-----

Alphabetisches Register

RS	Pag
Reislöffel	102 104 117 207 208
Relish-Pickles-Gestell	217 285 340 341
Rotweinwiege	275
Saftdispenser	207
Saftkrug	197 289 290 292
Sahne-/Zucker-Set	222 291
Sahnegießer	152 246 286 297
Sahnekännchen	145 291 2
Salat-/Vorlegebesteck	14 <> 70 104 117 207 208
Salatzange	145 210 273
Salz- und Pfeffergestell	152 223 237 266 267 272
Salzmühle	281
Sauce Set	278
Saucenlöffel	14 <> 70 117 208 272
Sauciere	142 176
Sauteuse	244
Schale	123 124 126 127 128 133 144 147 148 149 150 151 153 170 172 174 175 180 184 191 193 200 216 232 233 235 257 260 261 263 278 340 344
Schalenhalter	246 247
Schmuckablage	168 174
Schnapsbecher	339
Schneckengabel	102
Schneckenzange	102 273 274
Schneckenplatte	274
Serviergestell	219 285
Serviertablett	121 131 132 142 148 156 157 159 162 163 173 175 177 178 179 180 183 184 187 190 192 193 200 204 207 213 216 226 227 228 232 233 234 252 255 258 260 261 262 270 271 277 278 286 287 296
Servierwagen	346 <> 361
Serviettenhalter	190 191 232 256 287 296
Serviettenring	128 257
Set mit Porzellanschale	256
Shot Glass	152
Snackschale	275
Sorbetschale	98 124 276
Spaghettitopf	335
Speckstein	240
Speisekartenhalter	221 235
Stand für Plastik Platte	257
Stapelbare Gläserträger Tablett	233
Steakmessern	14 <> 70 84 86 241
Stielkasserolle	320 322 324 329 332
Suppenmarmite	206
Suppenschöpfer	14 <> 70 104 299
Suppenstation	206
Suppentasse	272
Suppenterrine	222 272
Street Cover	136 138
Strohalm Halter	314 2

T	Pag
Tablett	121 131 132 142 148 156 157 159 162 163 173 175 177 178 179 180 183 184 187 190 192 193 200 204 207 213 216 226 227 228 232 233 234 252 255 258 260 261 262 270 271 277 278 286 287 296
Tablett Gastronorm	183 184 192 213 226
Tablett für Rack	184 233 252
Tablett für Stoffservietten	297
Tablett, konkave	277
Tablett, oval	148 157 162 187 216 228 261 271
Tablett, quadratisch	132 148 156 162 163 183 193 200 227 255 260
Tablett, rechteckig	121 131 132 142 148 156 162 183 184 187 190 192 193 200 204 207 213 216 226 227 228 232 233 234 252 255 258 260 261 262 270 271 277 278 286 287 296
Tablett, rund	157 159 173 175 213 216 227 228 234 255 258 262
Tacoshalter	277
Tafelaufsatz	153 156 157 159 187 200
Teeglas	200
Teekanne	218 289 290 292 293 294
Teekanne, Isoliert	294
Teller	144 249 270
Teller cloche	219 221 222 234 249 271 274 279
Thermische Ringröhre	247 249
Tiefzange zum Servieren	210
Tiffin box	250
Tischnummer	183 221 235 276 279
Tischnummernständer	183 221 235 276 279
Tischnummern-Aufsteller	221 235 279
Tischrestebehälter	149 174 299
Tischset	132 138 183 192
Toastständer	276 286
Tortenheber	14 <> 70 104 116 207 208
Tranchiergabel	14 <> 70 102 104 117 207 208
Tranchiermesser	14 <> 70 84 86 241

T	Pag
Tropf-Parfüm Aussteller	223
Trüffel Hobel	281
Tumbler	176
U V W	
Universalschale	144 214 235 340 341 344
Universalschale auf Holz	275
Universalträger	168 174
Vorspeisenplatte	246 256
Vorspeisen Set	131
Yogurtkühler	208 221
Warmhalteteller	249
Wasserascher	149
Weinbecher	204 338 339
Wein-/Sekt Kühler	124 144 150 151 184 220 230 299 300 301 302 303 304 305 306 307 308 312 314 315 340 344
Weinkühler	302 303
Weinkühlerständer	124 126 133 151 220 230 231 300 301 302 303 304 305 307 313
Whisky Becher	339
Wokpfanne	331 335
Z	
Zahlsteller	149
Zahnstocherbehälter	183 193 217 223 232 237 266 267 272 278
Zucker- und Cocktailszange	210 291
Zuckerdose	145 152 218 289 290 292 293 294 296 297
Zuckergestell	222 223 285 291
Zuckerständer	265
Zuckerstangengefäß	191 218 232 287 294 296 297
Zuckerzange	210 273 291

Indice

A B	Pág.
Abrebotellas	280
Accesorios	80 <> 105
Aceitera	217 237 240 266
Apoyo para bolsas	282
Apoyo para chopsticks	80
Apoyo para cubiertos	82 100 171 175 193 207
Azucarera	191 218 232 287 294 296 297
Azucarero	145 152 218 289 290 292 293 294 296 297
Bac rond	256
Bajo plato	132 144 147 149 163 184 192 255 261 262 264 281 344
Bandeja	121 131 132 142 148 156 157 159 162 163 173 175 177 178 179 180 183 184 187 190 192 193 200 204 207 213 216 226 227 228 232 233 234 235 252 255 258 260 261 262 270 271 277 278 286 287 296
Bandeja con agujeros	175
Bandeja concavo	277
Bandeja cuadrada	132 148 156 162 163 183 193 200 227 255 260
Bandeja cuentas y propinas	174 299
Bandeja de fibra de carbono	120 121
Bandeja gn	183 184 192 213 226
Bandeja para estantes	184 233 252
Bandeja portaservilletas	297
Bandeja portavasos impilable	233
Bandeja rectangular	121 131 132 142 148 156 162 183 184 187 190 192 193 200 204 207 213 216 226 227 228 232 233 234 252 255 258 260 261 262 270 271 277 278 286 287 296
Bandeja redonda	157 159 173 175 213 216 227 228 234 252 255 258 262
Bandeja tartas	216 228
Baterias de cocina & accesorios	328
Bistequera	331
Bobina térmica	247 249
Bol à salade de fruits	144 214 235 307 340 344
Bol para caviar	217 236
Bol para limpiar dedos	144 274
Botella	240
Botella térmica	366 <> 369
C	
Cacerola	320 322 324 329 332
Cafetera	218 289 290 292 293 294
Cafetera térmica	289 290 294
Calentador de café	207
Calientador à inducción	206
Calientador eléctrico	206
Candelabro	219 225
Carros	346 <> 360
Cascanueces	280
Cazo	14 <> 70 104 299
Cenicero	149 152 274
Cenicero a columna	152
Centro mesa	153 156 157 159 187 200
Cesta	123 124 126 127 128 133 144 147 148 149 150 151 153 170 172 174 175 180 184 191 193 200 216 232 233 235 257 260 261 263 278 340 344
Cesta pan	133 144 147 148 149 184 191 193 216 232 233 235 257 260 263 278 340
Cesta para fruta	133 144 147 148 149 150 151 153 232 235 260 263 306 307 340 344
Cesto por aromaticos y condimentos	133 260 275 278
Cevichera	279
Chafing-dish	206 208
Chop sticks	80
Coctelera	299
Coctelera con vaso	299
Colador para cóctel	280
Colador para olla pastas	335
Columna porta cesta champany	309
Columna porta cubo champany	124 126 133 151 220 230 231 300 301 302 303 304 305 307 313
Contenedor para café	197 207
Contenedor para zumo de fruta	197 207
Contenedor sobres té	191 218 232 287 294 296 297
Copa caviar	217 236
Copa cóctel camarones	217 236
Copa con base	144 145 214 216 221 235 299
Copa de vidrio	216
Copa gazpacho/potage	272
Copa helado y macedonia	145 178 180 223 235 236 278 286 339
Copa mantequilla	217 236
Copa para intermezzo	98 124 276
Copa salsa	142 176 272
Copa soufflé	142 176 272
Copa térmica	235 278 286
Copa universal	100 176

C	Pág.
Copa vichyssoise	217 236 272
Copita	100 176 178 180 223
Cortador de trufas	281
Cuberteria	14 <> 70 84 86 94 96 100 102 104 116 117 158 161 174 204 207 208 241 272 280 297 299
Cubitera de champaña	150 221 231 308 312 313
Cubitera hielo	144 150 151 220 230 299 300 301 302 303 304 306 312 314 315 344
Cubitera hielo térmica	230 302 303 304
Cubito hielo LED	315
Cubo de champagne gigante	308
Cubo vino	124 144 150 151 184 220 230 299 300 301 302 303 304 305 306 307 308 312 314 315 340 344
Cubreplatos ovales	270 271
Cubreplatos, redondo	249 268 271
Cuchara arroz	102 104 117 207 208
Cuchara cocktail	14 <> 70 100 204
Cuchara de miel	96
Cuchara ensalada	14 <> 70 104 117 207 208
Cuchara multifuncional	94 161
Cuchara parmesán	14 <> 70
Cuchara servir	14 <> 70 102 104 117 207 208
Cucharita cappuccino	102 297
Cucharita caviar	280
Cucharita mezcladora	14 <> 70 102 104 297 314
Cucharita para sal	100 204
Cuchillo ostras	158
Cuchillo servir pescado	14 <> 70 100 113
Cuchillos	14 <> 70 84 86 102 116 158 241
Cúpula cobre-platos	219 221 222 234 249 271 274 279
Cuenco	144 147 148 149 175 176 180 200 214 216 223 233 235 257 275 307 338 340 341 344
Cuenco con bandeja	176 2 180 223
Cuenco con pedestal	144 214 235
Cúpula refrigerada	356 357
D E F	
Dispensador	207
Dosador sal/pimienta	152
Ensaladera	144 214 235 247 340 344
Entremesera	246 256
Escurridera	335
Finger Food	100 104 131 160 <> 165 170 174 183 193 200 204 210
Florero	281
Frutero	153 156 157 159 187
Fuente de marisco	142 159 268
Fuente oval	142 144 268 270
Fuente para Lasagne	247 256
Fuente pescado	142 268
G H I J L	
Golf club cucharita coctél	102 314
Gueridon	306
Hoguera con piedras naturales	240 242
Huevera	142 275
Individual en acero	183 192
Individual en madera	132
Individual en goma	136 <> 139
Inserto por finger food	131 163
Jarra	145
Jarra agua	197
Jarra leche	218 289 290 292 293 294
Jarra térmica	289 290
Jarrita lechera	152 246 286 297
Joyerero	168 174
Juego azucar	223 265 285 291
Juego café au lait	291 297
Juego leche, café y azucar	291 297
Lavaderos	144 274
Legumbreira	222 272
Legumbreira escoffier	272
M N O	
Mantèl individual	132 136 <> 138 183 192
Mantequillera	275 297
Marmeladero	223 267 297
Medida bar, doble	299
Micro tenedor	100 170 174
Mini bandeja	162 179 180 181 200 218
Mini cacerola	320 322 324
Mini cuenco	175
Mini spoon	100 204
Mini tenedor	100 204
Mini vaporizador	164
Molinillo chile	281
Molinillo hierbas	281
Molinillo pimienta	281
Molinillo sal	281
Mug	341
Número de mesa	183 221 235 276 279
Olla para pastas	335

Indice

P Q

	Pág.
Pala para tarta	14 <> 70 104 116 207 208
Pala pescado	14 <> 70 104 117
Palillero	183 193 217 223 232 237 266
	267 272 278
Panera	133 149 184 191 193 216 232 233
	257 263 278 340
Pedestal para tarta	171 175 214 215 218 219 225 264
	286
Petit marmite	206
Pimentero	152 223 237 266 267 272
Pinzas asados y verduras	145 210 273
Pinzas azucar	210 273 291
Pinzas azucar y aperitivos	210 291
Pinzas caracoles	102 273 274
Pinzas entremeses y pasteles	210 273
Pinzas espagueti	145 210 273
Pinzas espárragos	145 210 273
Pinzas frutas	210 273
Pinzas fundas para servir	210
Pinzas hielo	210 273 314
Pinzas hielo y limón	210
Pinzas llanas para servir	210
Pinzas pan y pasteles	210
Pinzas pasteles	210 273
Pinzas pasteles y tostadas	210 273
Pinzas por finger food	210
Pinzas servir	210
Pinzas verduras	145 210 273
Pinzimonio	247
Pizarra	240
Plancha refrigerada	356 357
Platillo para mantequilla	262 265
Platito bajo botellas	183 184 193 255 262 265 281
Platito bajo vasos	255 262 265
Plato caracoles	274
Plato concavo	191 233
Plato de presentación	132 144 147 149 163 184 192 255
	261 262 264 281 344
Plato huevos	145 274
Plato ostras	156 157 159
Plato para pan	147 265
Plato térmico	249
Ponchera	221 225 299
Porcelana	247 256
Porta bastoncillos de pan	149 176 184 191 193 277
Porta botellas	275 277
Porta cepillo de dientes	299
Porta cucharitas	299
Porta dulces	214 215 225 264 286
Porta galletas saladas	176
Porta granos	131 234
Porta jabón	297
Porta informaciones	221 235
Porta macaron	217 265 286
Porta numero de mesa	183 221 235 276 279
Porta paliillas	183 193 217 223 232 237 266
	267 272 278
Porta patatas fritas	163 240 276
Porta pescado	156 157 158 221 229
Porta servilletas	190 191 232 256 287 296
Porta sorpresas	168 174
Porta Tacos	277
Porta tarjeta	279
Porta tostadas	276 286
Porta vasos	257
Portapan	149 176 183 184 191 193 277
Portaplatos de plastica	257
Posabotella	183 184 193 255 262 265 281
Posavaso	255 262 265
Posavaso por mug	341
Pote leche	335
Presentoire	161 219 225 285 286 287
Puerto paté/mantequilla/caviar	223 267 297
Quarta Posata	88 <> 91 161 173
Quesera	131 217 237 257 258 260 261 263
	267 274

R S

Rallador	280
Refrigerador para yogurt	208 221
Rompenueces	280
Salero y pimentero	152 223 237 266 267 272
Salsera	142 272
Saucière	142 176
Sauteuse	244
Servicio para aperitivos	131
Servicio para buffet	200 204
Servicio para café con leche	222 291
Servicio para caviar	236
Servicio para champagne	303
Servicio para ensaladas	247
Servicio para Lasagne	247 256
Servicio para salsa	278
Servicio por aromaticos y condimentos	133 260 275 278
Servicio por entremes	217
Servilletero	128 257

R S

	Pág.
Sopera	206 222 272
Soportes de buffet	194 195
Soporte platos	219 285
Soporte multi usos	246 247
Street cover	136 138

T V W

Tapa	222 270 272
Tapa legumbrera y sopera	222 272
Tarjetas	183 221 235 276 279
Tazas	341
Tenedor caracoles	102
Tenedor cocktail	100 170 174 204
Tenedor diápasón	102
Tenedor ensalada	14 <> 70 104 117 207 208
Tenedor langostas	92 102
Tenedor ostras	14 <> 70
Tenedor pescado	14 <> 70 104 117
Tenedor servir	14 <> 70 102 104 117 207 208
Tetera	218 289 290 292 293 294
Tetera térmica	294
Tiffin box	250
Tumbler	176
Vaso	152 176 200 204 338 339 344
Versador de perfume en gotas	223
Vinagrera	217 237 240 266
Vinagreras con saleros	131 223 237 257 258 260 261 263
	266 267
Wok	331 335

Index

	Pag	Pag	Pag	Pag	Pag	Pag					
025	280	260	174	418	183	548	299	666C	151	727	276
03180	347	260	240	418	192	549	162	666C	307	729	299
03280	347	262G	157	419	184	549	200	666CMG	126	730	150
03680	347	262	157	419	192	550	341	666E	230	730	312
03780	347	264	278	420	183	551	299	666E	304	737	180
041104	351	270	190	420	192	552	341	666F	220	737	181
042104	351	270	232	421	100	553	338	666F	300	738	176
046104	351	272A	249	422	183	554	338	666H	301	739	175
047	280	272B	249	422	193	555N	204	666HMG	126	740	100
047104	351	272C	249	423	100	555	338	666I	231	740	176
048	280	273A	249	423	183	557	148	666I	313	742	177
049	280	273B	249	423	193	557	187	666K	309	742	179
051104	350	280	279	424	100	558	148	666L	305	742	180
052104	350	281	279	424	232	558G	157	666M	305	743	174
056104	350	289	163	425	250	558V	157	666MG	124	744	170
057104	350	289	240	426	183	559	149	666W	306	744	174
09150	347	289	240	427	184	561	148	666Z	306	744	191
09250	347	289	276	427	193	561	187	668MG	124	745	177
094	278	292	265	428	184	562	148	668	230	745	178
098	278	293	264	428	192	562G	156	668	304	745	179
09841	278	301	236	429	184	562V	156	669	230	745	180
099	344	301A	236	430	184	567	149	669	304	746	179
105	265	301C	236	430	305	568	149	669MG	124	746	180
106	265	301B	236	438	150	569	149	670	296	746	181
133	281	304	267	438	315	570	152	671	281	747	178
140	227	306	257	439	150	570	246	672	303	747	180
140K	227	307	257	439	315	571	152	674	231	748	168
141GN	226	308	257	446	276	574	246	674	313	748	174
144GN	226	309	266	447N	281	575	246	675	277	749	170
144GN2	226	310	257	451	276	576	247	675P	277	749	174
146GN	226	312	266	451	286	579	247	676	302	750	100
151	207	313	255	462N	281	580	247	678	303	750	170
152	277	315	255	464N	281	581	246	679	303	750	174
154	233	316	255	466N	281	582	246	680	303	751	274
155	131	317	257	473N	280	582	247	681	303	752	274
155	234	319	255	485	158	583	247	682	197	753	171
156	276	320	255	496AC	277	588P	204	683	314	753	175
163	131	321	257	497	266	588	338	684	314	754	173
168	258	323	255	498	237	590	341	685	231	754	175
169	258	324	266	499	297	591P	204	685	313	755	282
170	144	325	266	500	175	591	338	686	231	756	282
171	144	331	261	501	175	592	341	686	313	757	282
175	144	332	261	502	263	593	341	688	150	758	282
176	144	333	261	503	275	594	246	688	315	760	210
178	142	335	261	504	275	594	297	689	150	761	210
179	145	336	261	505	233	595	297	689	315	762	210
180	145	337	261	505	260	596	150	691	197	763	210
184	142	350	266	506	237	596	307	693	368	765	210
186	142	355	275	507	237	597	151	700	163	766	210
187	142	356	275	508	266	597	306	700	240	767	210
188	145	356	278	509	266	598	151	700	296	768	210
204	265	364A	294	510	266	598	306	702	237	769	210
205	190	364B	294	510	266	598	308	702	286	769	291
205	233	364T	294	510ST	266	599	133	703AC	169	771	273
205	287	370	301	511	272	599	150	703AC	174	772	273
206	190	371	301	511	272	599	307	703	297	774	273
206	233	380	314	512	267	599	307	704	191	775	273
206	287	381	314	512	267	599	340	704	232	777	273
206	296	382	194	513	237	601	267	704	287	778	273
208	265	382	273	513	237	602	267	704	296	779	102
209	262	382	314	514P	152	603	267	706	297	779	273
210	262	383	194	514S	152	604	267	707	275	779	274
212A	187	384	195	516	191	605	340	708	299	787	131
212	187	385	195	516	232	606	341	709	279	789	132
220	225	386	195	516	287	607	151	711	275	789	132
222A	187	387	194	516	296	608	150	712	236	791	132
222	187	388	195	518	232	609	147	713	236	791	132
225	356	389	195	520	162	611	267	714	236	791	163
225	357	390	194	522	263	612	147	715	265	791	163
229	278	391	194	523	175	616AC	147	716	262	791AC	131
230	278	403	183	525	237	617	147	717	176	791AC	163
232	277	403	192	526	286	620	240	718	176	791E	162
235G	159	404	183	527	339	639	291	719	152	793	131
235	159	404	193	528	274	649	291	720	297	794	131
236	208	404	193	531	339	657	221	721	235	795	132
242	153	406	260	533	339	658	315	721	286	796	132
242G	158	407	260	534	339	660	303	722	236	799N	275
24222G	158	408	260	535	339	661	299	723	236	799P	275
252	156	409	260	536	339	662	302	725	236	799W	275
252G	156	410	260	543N	204	663	302	727	98	804	133
254	235	411	260	543	339	664	302	727B	98	844	263
258	225	415	234	544	275	665	299	727MG	124	870	149
258	286	416	183	545	299	666	302	727N	98	870	149
260	163	416	193	546	299	666A	303	727O	98	870	191
260	169	417	184	547	299	666B	133	727OI	98	871	153

Index

Pag		Pag		Pag		Pag		Pag		Pag	
871	191	976	217	7001B	229	16440	258	24720	271	28222	242
872	176	976C	217	7002B	229	16450	258	24722	219	28232	240
874	144	976S	217	7003A	264	16535	258	24722	271	28232	242
878	145	976C	285	7003B	264	17230	142	24724	219	28327	234
879	145	976S	285	7004A	229	17240	142	24724	271	28335	234
880	144	978	215	7004B	229	17250	142	24726	219	28340	234
881	145	980B	215	7011	200	17355	142	24726	271	28430	234
882	144	980A	215	7011E	200	17370	142	24728	219	28435	234
883	335	981A	214	7012	204	17427	142	24728	271	28440	234
884	144	981B	214	7070	225	17435	142	24730	219	28445	234
886	344	982	216	7071	225	17440	142	24730	271	28450	234
888	344	982	218	7072	225	17726	142	24731	219	28460	234
891	344	983	221	7073	225	17731	142	24731	271	28730	228
892	344	984	219	7086	208	18130	142	24732	219	28740	228
899	151	984	285	7087	208	18140	142	24732	271	28750	228
899	312	985	219	7090	208	18235	142	24733	219	28760	228
901	276	985	285	7092	219	18240	142	24733	271	28830	228
902	163	986	221	7093	219	18514	144	25035	227	28840	228
902	240	987	221	7094	219	18520	144	25040	227	28850	228
902	296	988	223	7199	206	18524	144	25127	268	28860	228
903	276	989	219	7199A	206	19931	262	25130	268	29419	264
904	274	989	285	7199B	206	20130	262	25135	268	29424	264
905	277	990	178	7199C	206	20140	262	25140	268	29535	228
905P	277	990	180	7201	206	20150	262	25327	271	29645	228
906	80	990	223	7201A	206	20240	262	25335	221	29745	228
906	82	994A	235	7201B	206	20250	262	25335	271	29840	228
907	235	994B	235	7201C	206	20325	262	25340	271	30280	358
909	151	994C	279	7206	207	20331	262	25506	161	30538	255
909	312	995A	221	7208	207	20560	190	25506	286	30545	255
910	151	995B	221	10192	352	20560	233	25508	161	30980	358
910	312	996	276	10292	352	20560	287	25508	286	31440	277
911	274	998	275	10333	264	20660	190	25514	225	31455	277
912	151	999C	152	10335	264	20660	233	25514	287	31802	266
912	312	1001	128	10432	281	20660	287	25520	225	32250	360
913	279	1003	128	10692	352	20660	296	25520	287	32950	360
914	180	1004	128	10792	352	20724	232	25524	225	33298	359
914	181	1005	128	12150	348	20730	232	25524	287	33998	359
914	218	1006	128	12250	348	20734	232	25627	227	36101	294
915	82	1009	127	12650	348	21126	271	25635	227	36104	294
916	176	1010	127	12750	348	21131	271	25640	227	36106	294
918	176	1011	126	13132	264	22512	234	25714	225	36108	294
919	172	1012	126	13626	296	22512	279	25714	286	36110	294
919	175	1013	126	13760	227	22522	234	25720	225	36116	294
920	100	1014	126	13860	227	22522	279	25720	286	36202	294
920	171	1016	123	13960	227	22528	234	25728	225	36204	294
920	175	1017	123	14130	226	22528	279	25728	286	36206	294
922	223	1581	335	14135	226	23125	268	25920	235	36208	294
935	217	1591	335	14140	226	23130	268	25928	235	36301	294
935	286	2180	331	14145	226	23135	268	26202	153	36304	294
937	216	3100J	139	14150	226	23140	268	26202G	158	36306	294
938	216	3100S7	139	14160	226	23145	268	26203	153	36308	294
939	222	3101H7	139	14180	226	23150	268	26203G	158	36316	294
939	291	3101Q7	139	14190	357	23160	268	26204	153	36606	294
940	222	3102F7	139	14270	121	23330	268	26204G	158	36608	294
940	291	3102N7	139	14290	357	23335	268	26303	270	36704	294
940E	222	3200J	139	14440	226	23340	268	26403	270	36706	294
940E	291	3200S7	139	14445	226	23345	268	26524	190	42945	252
941	299	3201H7	139	14450	226	23350	268	26524	232	42963	252
941	314	3201Q7	139	14460	226	23535	270	26524	287	51610	232
942	223	3202F7	139	14480	226	23540	270	26530	190	51610	287
943	223	3202N7	139	14630	226	23635	270	26530	232	51710	344
943	223	3300J	139	14635	226	23640	270	26530	287	51722	344
947	223	3300S7	139	14640	226	23825	271	26534	190	51728	344
948	305	3301H7	139	14645	226	23830	271	26534	232	51755	344
949	221	3301Q7	139	14650	226	23835	271	26534	287	52405	286
956	274	3302F7	139	14660	226	23840	271	26602	270	52603	162
957	218	3302N7	139	14680	226	23845	271	26702	270	52604	162
958	216	3403F7	137	15014	191	24155	268	26820	271	52922	162
959	216	3403N7	137	15014	233	24170	268	26824	271	53012	164
960	216	3404J	137	15018	191	24202	153	26826	271	53022	164
963GN	213	3404S7	137	15018	233	24202G	158	26827	271	53706	158
968	217	3405H7	137	15020	191	24355	268	26828	271	53706	200
969	217	3405Q7	137	15020	233	24370	268	26830	271	53712	162
970	217	3503F7	137	15022	191	24530	271	26831	271	53712	200
971	217	3503N7	137	15022	233	24535	271	26833	271	55737	148
972	220	3504J	137	15024	191	24540	271	26928	268	55737	187
972P	220	3504S7	137	15024	233	24545	271	27228	249	55837	148
972	300	3505H7	137	15026	191	24550	271	27230	249	56012	149
972P	300	3505Q7	137	15026	233	24710	219	27233	249	56012	200
973	220	3600J	139	15028	191	24710	271	27328	249	56015	149
973P	220	3600S7	139	15028	233	24713	219	27330	249	56015	200
973	300	3601H7	139	15338	233	24713	271	27333	249	56022	149
973P	300	3601Q7	139	15338	252	24714	219	28215	240	56022G	157
974	219	3602F7	139	16190	356	24714	271	28215	242	56022V	157
975	217	3602N7	139	16290	356	24720	219	28222	240	56022	200

Index

Pag		Pag		Pag		Pag		Pag		Pag	
56032	149	64110	290	78135	244	96530	213	217932	330	10001144	84
56032	200	64112	290	78140	244	96535	213	247075	219	10001144B	84
56123	148	64116	290	78214	272	96540	213	247075	271	10001144N	84
56123	187	64202	290	78218	272	96545	213	247100	219	10001144O	84
56315	148	64204	290	78220	272	96550	213	247100	271	10001144OI	84
56315	200	64206	290	78222	272	96560	213	247132	219	10001144	241
56322	148	64208	290	78224	272	96613	213	247132	271	10001147	102
56322	200	64210	290	78226	272	96619	213	247145	219	10001150	102
56415	148	64300	290	78228	272	96624	213	247145	271	10001150	314
56422	148	64301	290	78830	132	96627	213	280120	322	10001151	299
56422G	156	64302	290	78850	132	96635	213	280122	322	10001175	82
56422V	156	64304	290	79230	132	96640	213	280124	322	10001175B	82
57220	240	64306	290	79250	132	96727	213	281109	322	10001175N	82
57234	240	64308	290	79715	133	96735	213	281114	322	10001175O	82
57262	240	64310	290	79720	133	96740	213	281116	322	10001175OI	82
58912	340	64312	290	83422	235	97413	285	282112	322	10001175	207
58922	340	64316	290	83434	235	97419	285	282120	322	10061101	116
58928	133	64402	290	84331	263	97713	214	282122	322	10061102	116
58928	307	64402P	290	86320	235	97719	214	282124	322	10061103	116
58928	340	64404	290	86420	235	97803	215	282128	322	10061104	116
58970	308	64404P	290	87504	145	98402	219	283124	322	10061105	116
59870	308	64406	290	87508	145	98402	285	283128	322	10061106	116
61322	147	64406P	290	92727	216	100222	128	284122	323	10061107	116
61340	147	64408	290	92735	216	100240	128	284126	323	10061110	117
61422	147	64408P	290	92740	216	120120	329	284130	323	10061111	117
61440	147	64504	290	92830	216	120124	329	290576	247	10061115	116
61739	147	64506	290	92835	216	121116	329	430350	237	10061116	116
62101	289	64512	290	92840	216	122120	329	430491	267	10061120	117
62102	289	64604	289	92845	216	122124	329	430491SS	267	10061121	117
62104	289	64606	289	92850	216	123128	329	430510SS	237	10061122	117
62106	289	64612	289	92860	216	124126	329	430510SS	237	10061123	117
62108	289	65102	293	93612	222	150008	332	430510ST	266	10061140	117
62110	289	65104	293	93622	222	150014	332	430511SS	272	10061142	117
62112	289	65106	293	93628	222	150120	332	430602	267	10101136	86
62116	289	65108	293	94003	223	150122	332	647150	290	10101136	241
62202	289	65110	293	94003	285	150124	332	648150	289	10131140	272
62204	289	65112	293	94003	291	151116	332	720411	207	10141136	86
62206	289	65116	293	94004	223	152120	332	720419	207	10141136	241
62208	289	65202	293	94004	285	152122	332	799906	209	10201110	208
62210	289	65204	293	94004	291	152124	332	799909	209	10201111	208
62301	289	65206	293	94005	222	153126	332	10001108	280	10201116	208
62302	289	65208	293	94005	291	153130	332	10001109	104	10201122	208
62304	289	65301	293	94414	222	157122	335	10001110	104	10201123	208
62306	289	65302	293	94418	222	157222	335	10001110	207	10201136	86
62308	289	65304	293	94420	222	157830	335	10001111	104	10201136	241
62310	289	65306	293	94422	222	157922	334	10001111	207	10201140	208
62312	289	65308	293	94424	222	157926	334	10001115	104	10201141	208
62316	289	65310	293	94426	222	157930	334	10001116	104	10201142	208
62402	289	65312	293	94428	222	180120	320	10001116	207	10201143	102
62402P	289	65316	293	94514	222	180120O	324	10001120	104	10201143	208
62404	289	65402	293	94518	222	180122	320	10001121	104	10201144	102
62404P	289	65404	293	94520	222	180122O	324	10001122	104	10201144	297
62406	289	65406	293	94522	222	180124	320	10001122	207	10231136	86
62406P	289	65408	293	94524	222	180124O	324	10001123	104	10231136	241
62408	289	67301	230	94526	222	181109	320	10001123	207	10341136	86
62408P	289	67301	304	94528	222	181109O	324	10001124	104	10341136	241
63102	292	67304	230	94614	222	181114	320	10001125	102	10341146	94
63104	292	67304	304	94618	222	181114O	324	10001126	102	10341146B	94
63106	292	67701	302	94620	222	181116	320	10001127	104	10341146N	94
63108	292	67704	302	94622	222	181116O	324	10001128	80	10341146O	94
63110	292	68702	197	94624	222	182112	320	10001128B	80	10341146OI	94
63112	292	69202	197	94626	222	182112O	324	10001128N	80	10341146	161
63116	292	70110	272	94628	222	182118	320	10001128O	80	10521108	100
63202	292	70115	272	95014	214	182118O	324	10001128OI	80	10521108	204
63204	292	70130	272	95020	214	182120	320	10001129	90	10521131	100
63206	292	72611	276	95024	214	182120O	324	10001129	161	10521131	204
63208	292	72620	276	95028	214	182122	320	10001129	173	10701136	86
63301	292	73112	272	95104	218	182122O	324	10001133	96	10711136	86
63302	292	73214	272	95106	218	182124	320	10001133B	96	TU0687G	197
63304	292	73218	272	95202	218	182124O	324	10001133N	96	TU0692V	197
63306	292	73220	272	95206	218	183124	320	10001133O	96		
63308	292	73222	272	95302	218	183124O	324	10001133OI	96		
63310	292	73224	272	95304	218	183128	320	10001136	86		
63312	292	73226	272	95406	218	183128O	324	10001136	241		
63316	292	73228	272	95613	274	184122	321	10001138	102		
63404	292	73614	272	96330	213	184122O	325	10001139	92		
63406	292	73618	272	96335	213	184126	321	10001139B	92		
63408	292	73620	272	96340	213	184126O	325	10001139N	92		
63510	292	73622	272	96345	213	184130	321	10001139O	92		
63516	292	73624	272	96350	213	184130O	325	10001139OI	92		
64101	290	73626	272	96360	213	213132	331	10001139	102		
64102	290	73628	272	96440	213	217828	331	10001140	102		
64104	290	74116	274	96445	213	217920	330	10001141	104		
64106	290	78125	244	96450	213	217924	330	10001142	104		
64108	290	78130	244	96460	213	217928	330	10001142	207		



25065 LUMEZZANE - BRESCIA - ITALIA - VIA MONTINI 176
TEL. 0308921441 - FAX 0308925075 - MEPRA@MEPRA.IT
WWW.MEPRA.COM